

ASSEMBLY INSTRUCTION

2+CHAISE

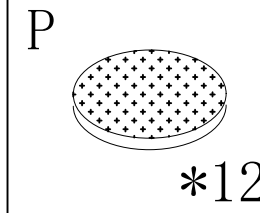

STEP 1:

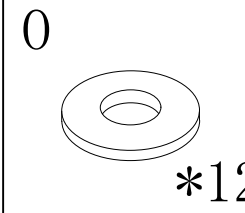
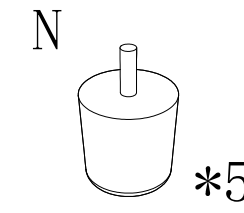
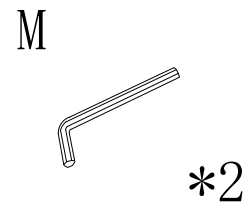
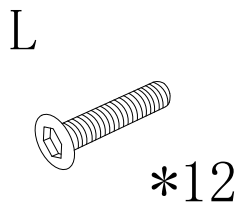
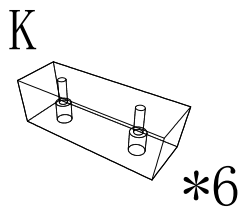
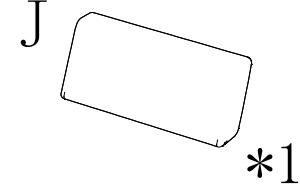
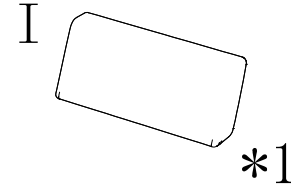
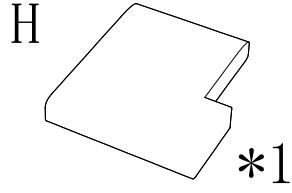
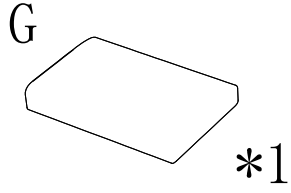
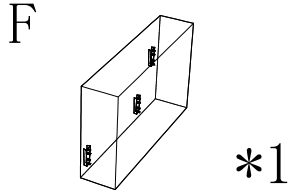
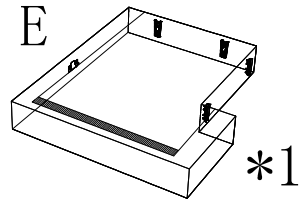
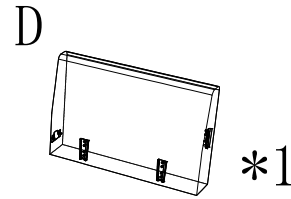
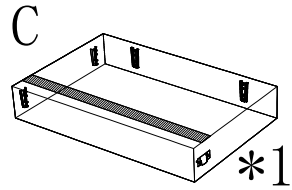
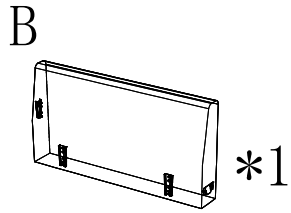
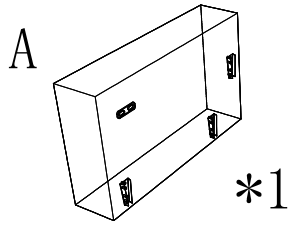
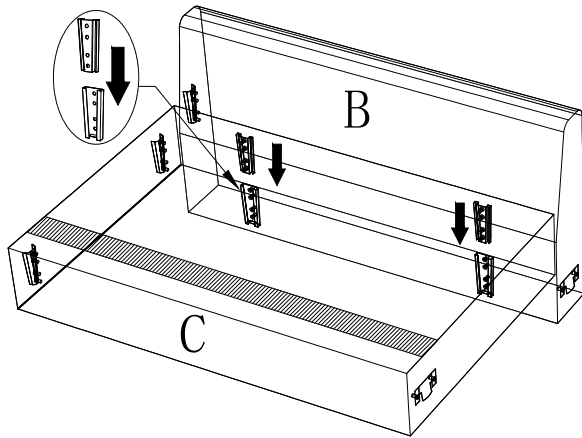

STEP 2:

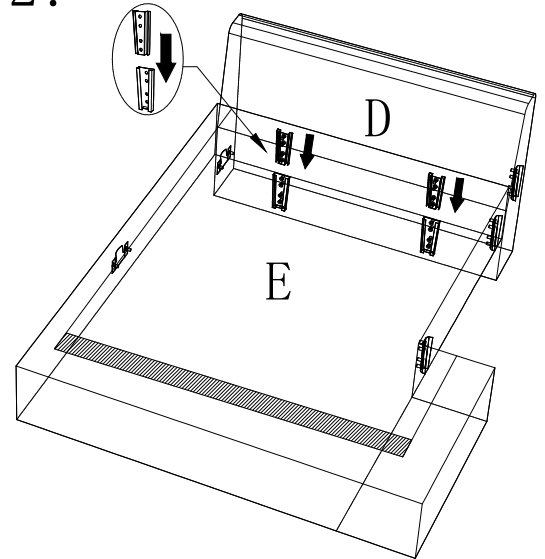



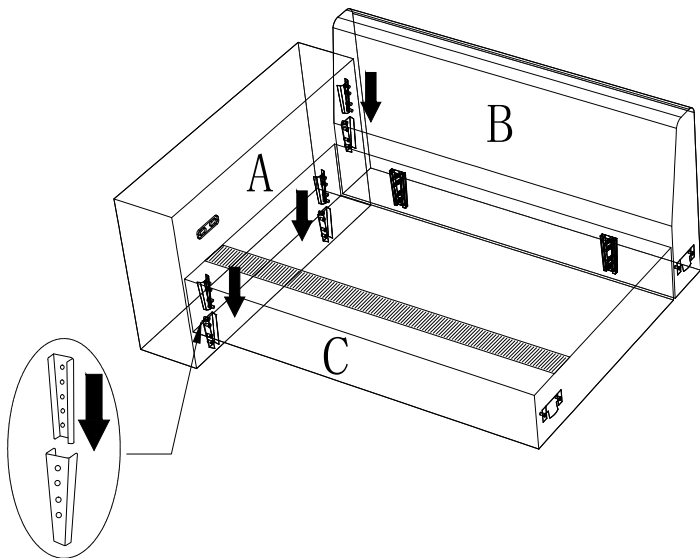

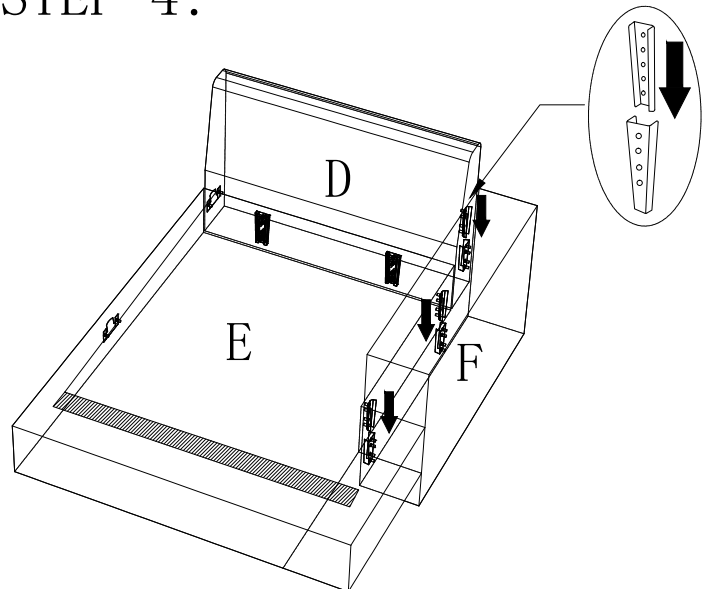

STEP 3:



STEP 4:







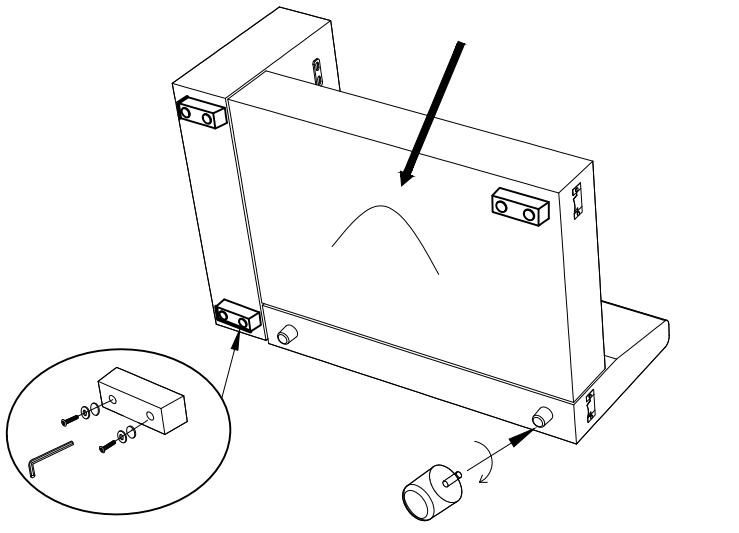

STEP 5:

K	 *3	N	 *2	O	 *6	P	 *6
L	 *6	I	 *1				
M	 *1						



STEP 6:

K	 *3	N	 *3	O	 *6	P	 *6
L	 *6						
M	 *1						

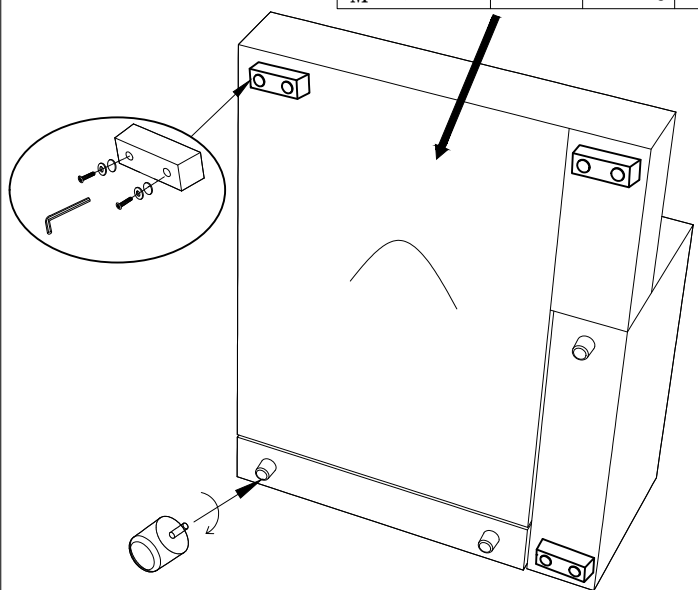

STEP 7:

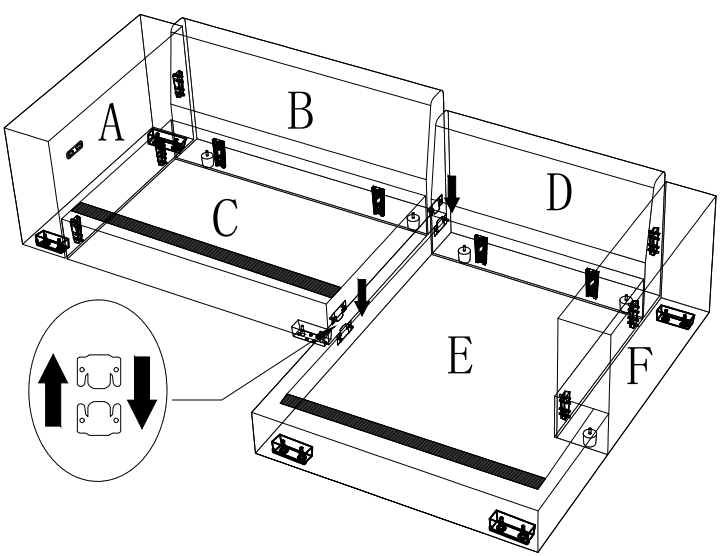

STEP 8:

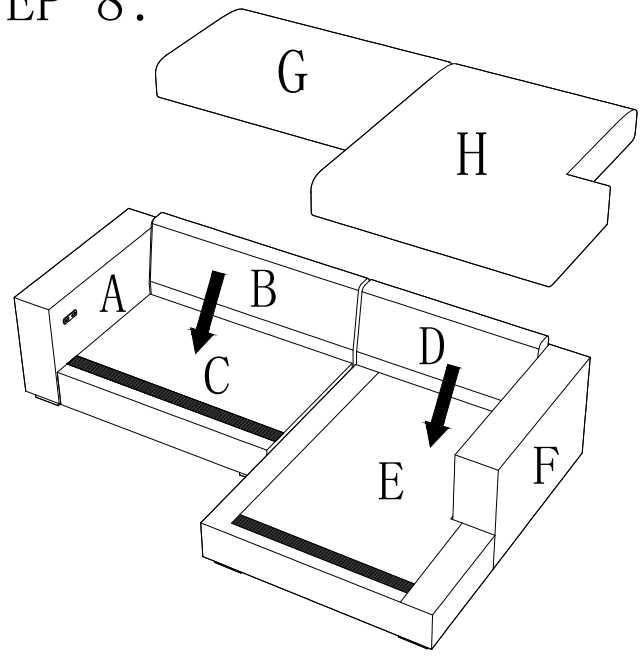

STEP 9:

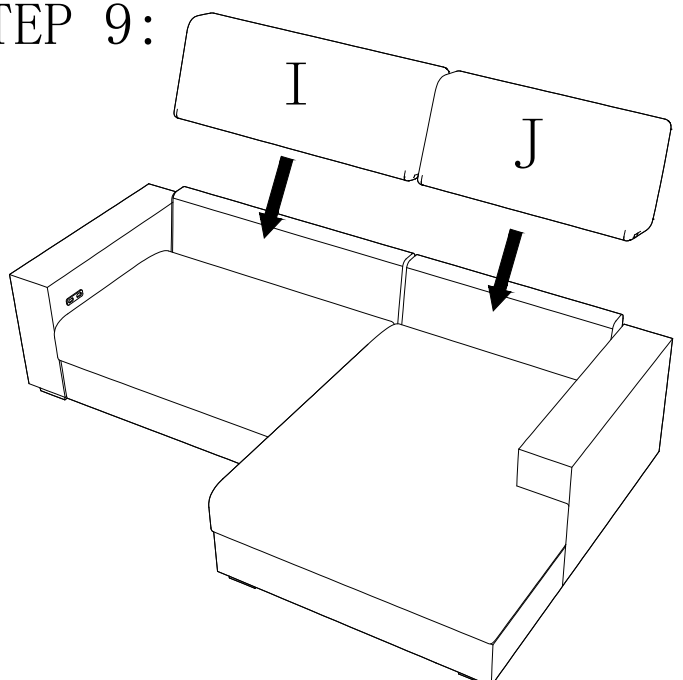

STEP 10:

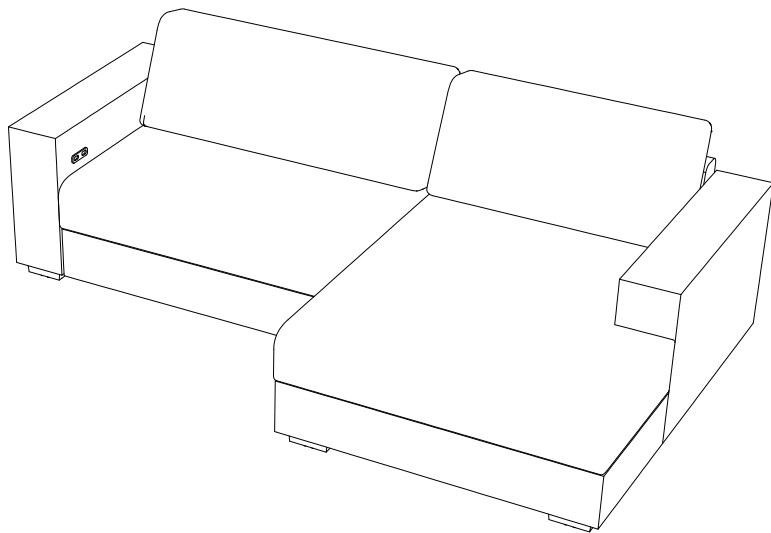

ASSEMBLY INSTRUCTION

OTTOMAN

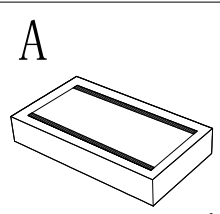

*1

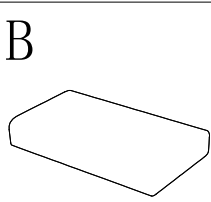

*1

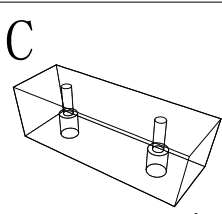

*4

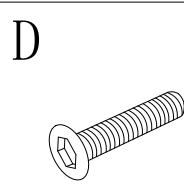

*8

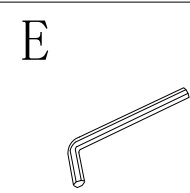

*1

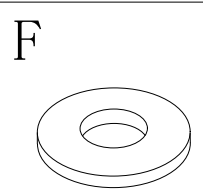

*8

STEP 1:

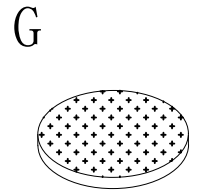
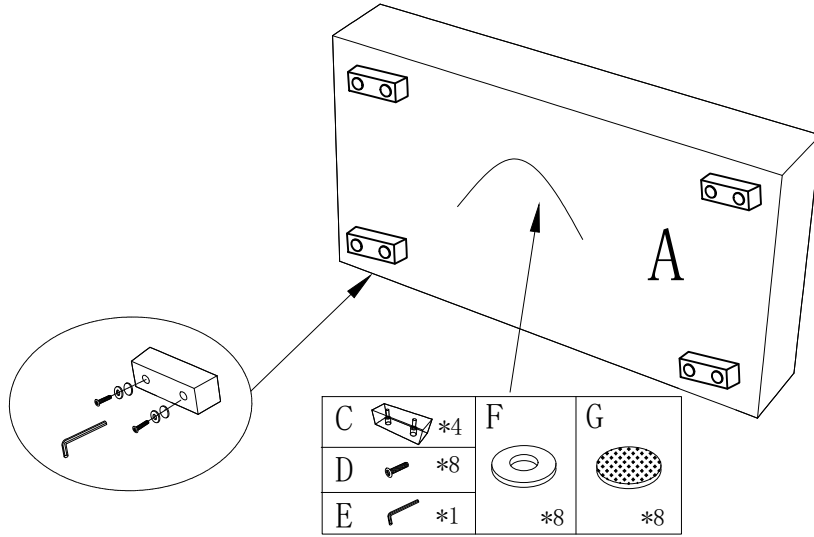

*8

STEP 2:

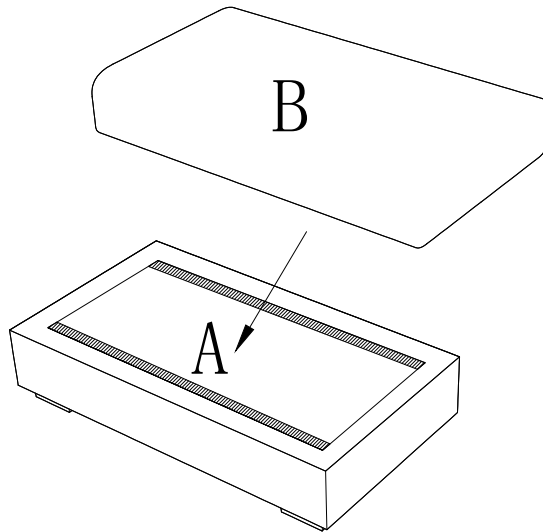

STEP 3:

