

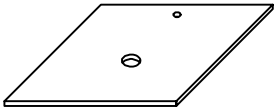









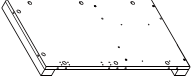

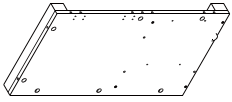
# Bathroom Vanity

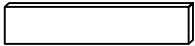

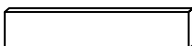
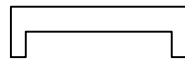
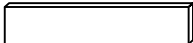
PARTS LIST			HARDWARE LIST		
NO.	DESCRIPTION	QTY	NO.	DESCRIPTION	QTY
1		1	A	 CAM LOCK	37
			B	 CAM SCREW	37
2		1	C	 CAM LOCK COVER	37
			D	 WOODEN DOWEL	26
3		1	E	 SCREW	40
4		1	F	 HINGE	4
5		1	G	 HASCREW ( $\phi 4 \times 18 \text{MM}$ )	4
6		1	H	 HANDLE 128MM	2
7		1	I	 $\phi 3.5 \times 35 \text{MM}$	2
			J	 $\phi 6 \times 30 \text{MM}$	2
8		1	K	 BOTTOM DRAIN HOLE COVER	1
9		1	L	 CORNER IRON	2
			M	 COUNTER TOP BASIN HOLDER	1
10		1			
L1		1			
L2		1			
R1		1			
R2		1			

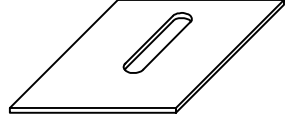
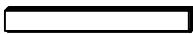

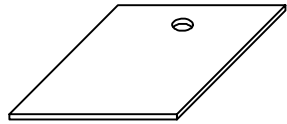
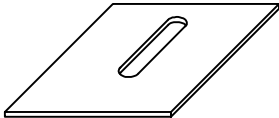
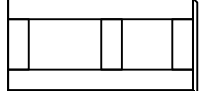
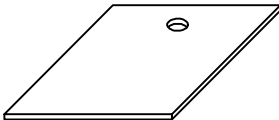
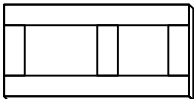
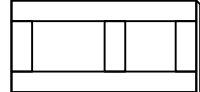
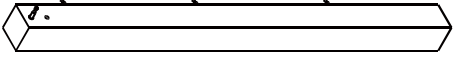
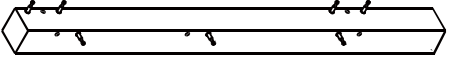
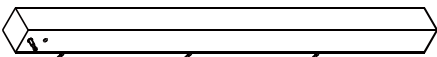
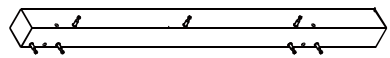
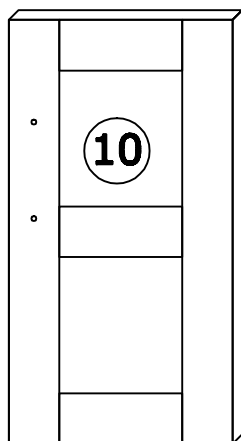
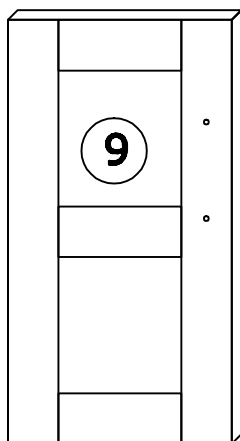
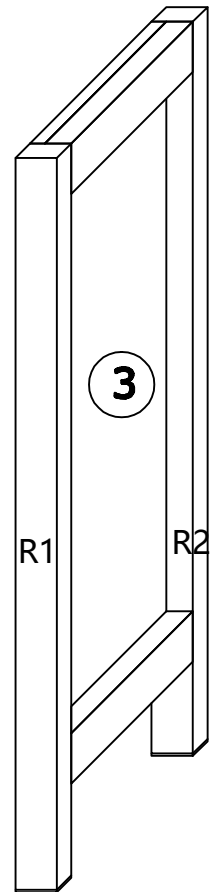
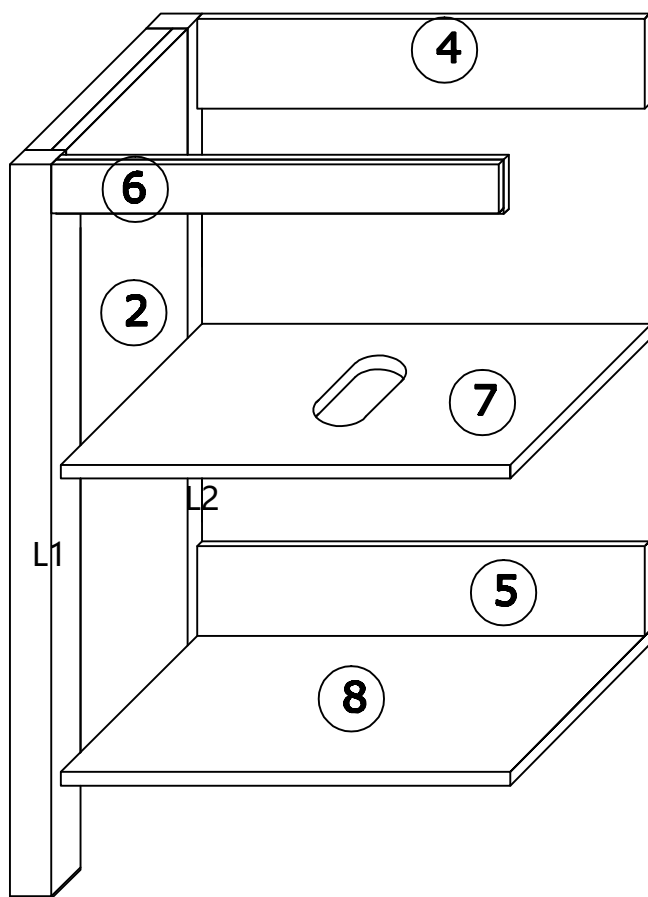
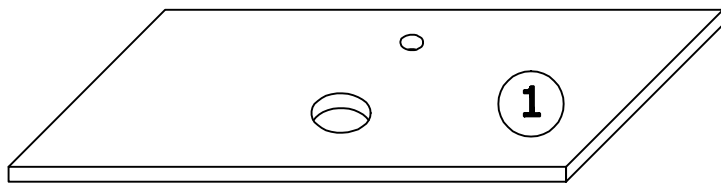
HARDWARE LIST

B  22 pcs

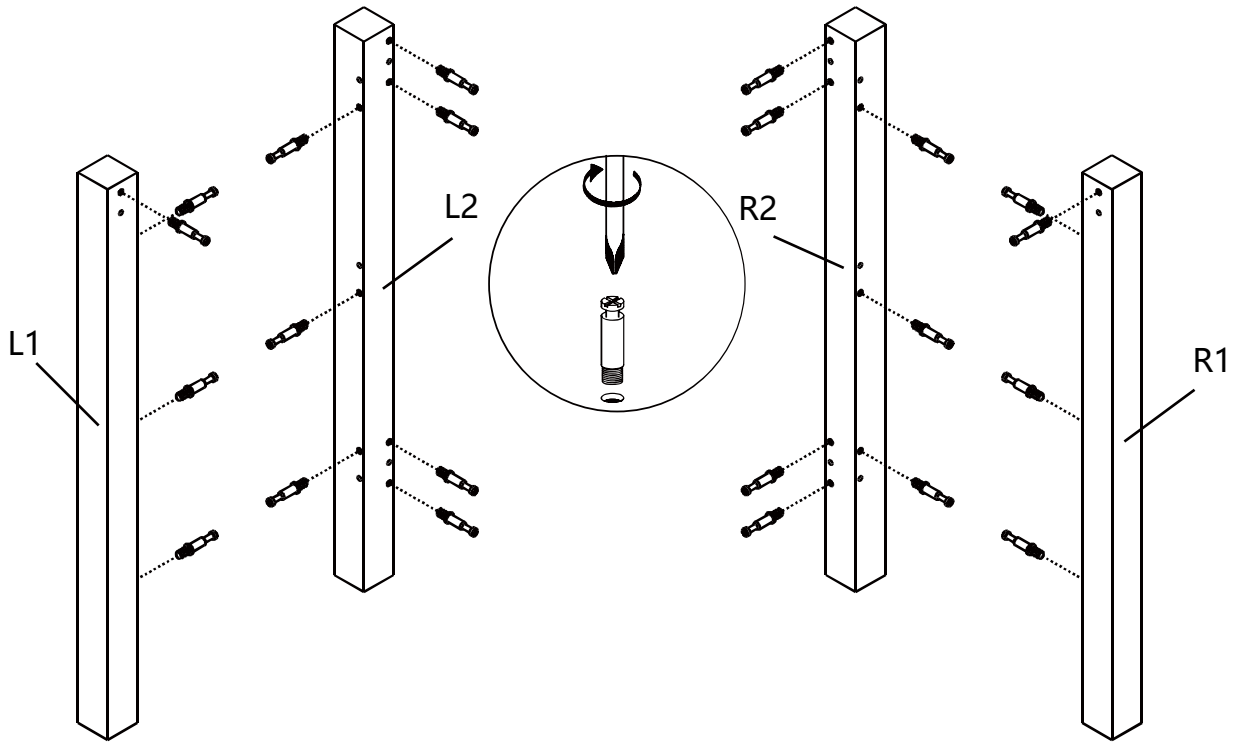
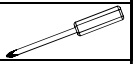

HARDWARE LIST

A  12 pcs

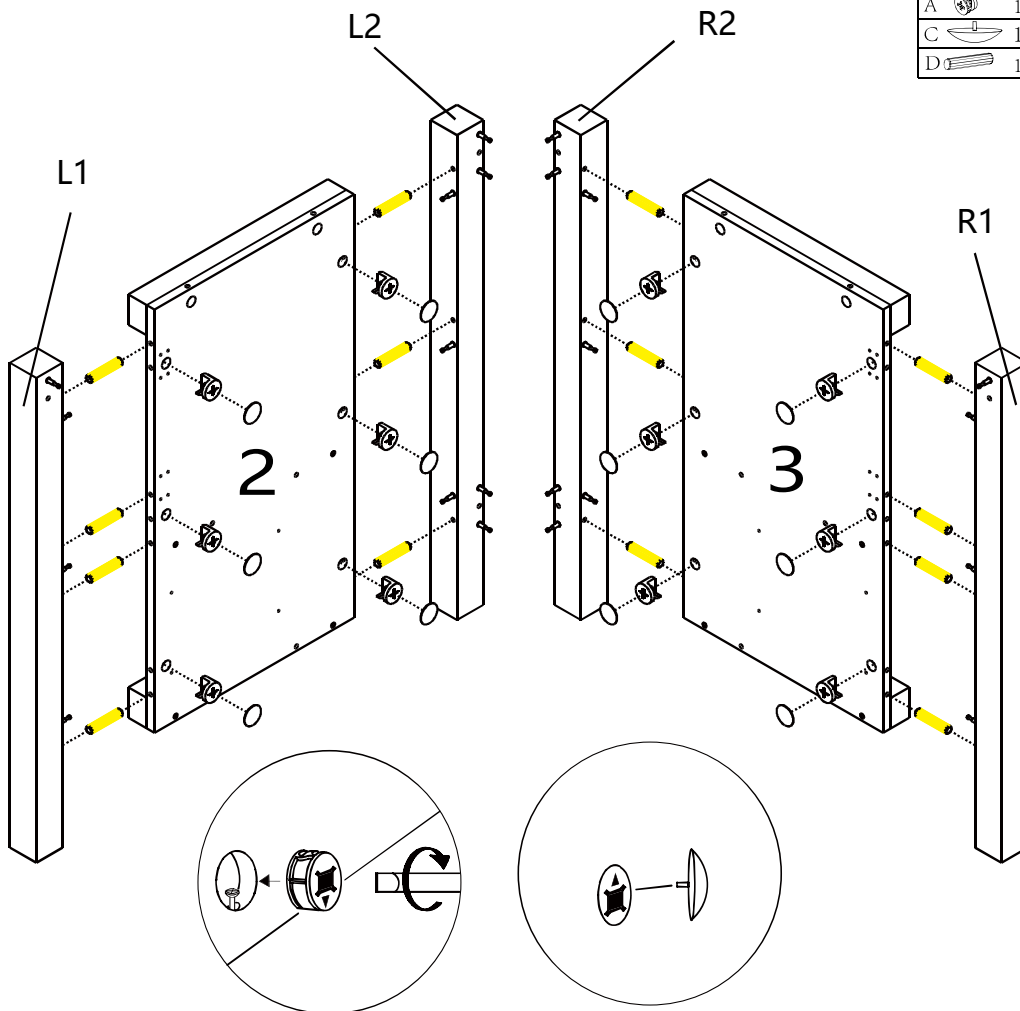
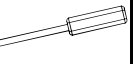

C  12 pcs

D  14 pcs

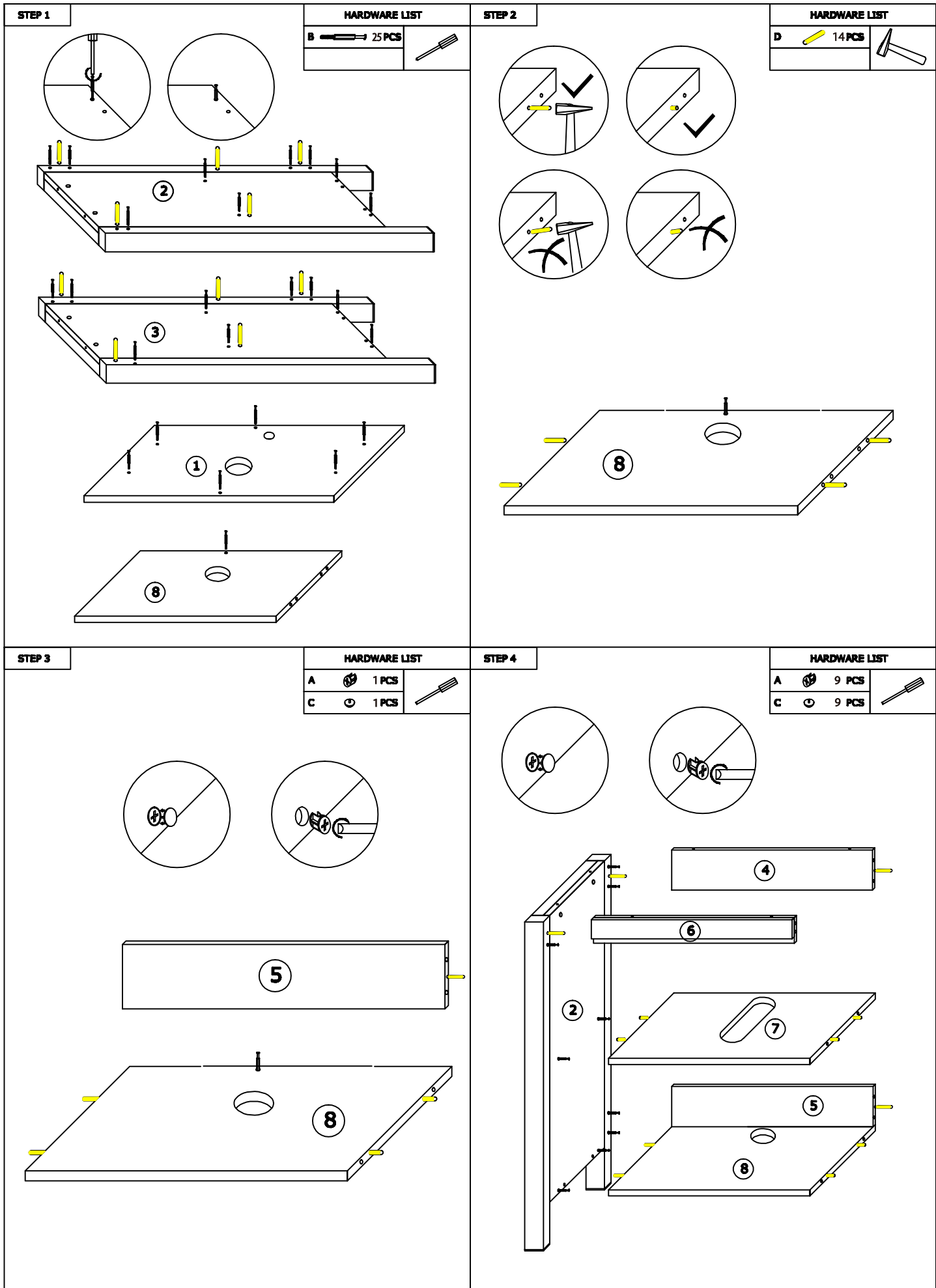



**STEP 5**

HARDWARE LIST		
A		9 PCS
C		9 PCS

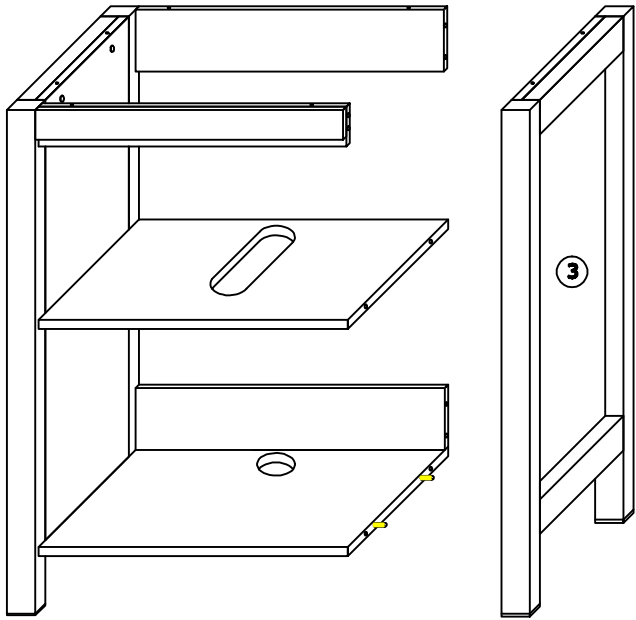
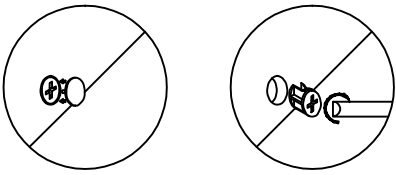

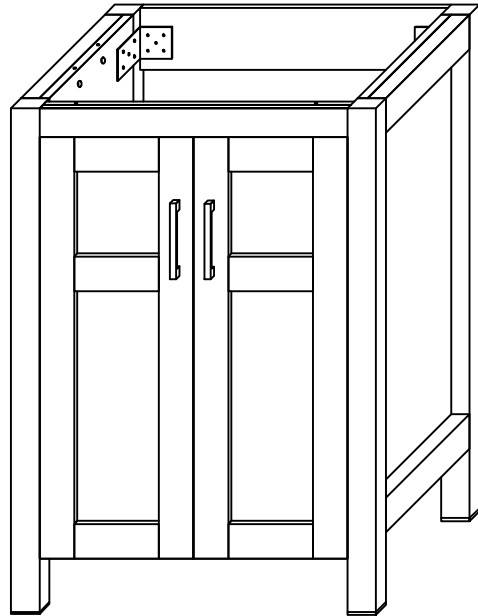
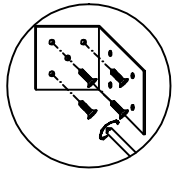
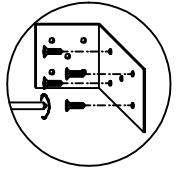
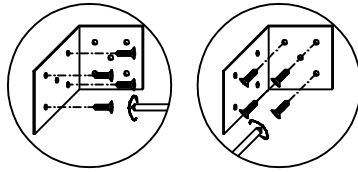

**STEP 6**

HARDWARE LIST		
M		2PCS
E		16 PCS



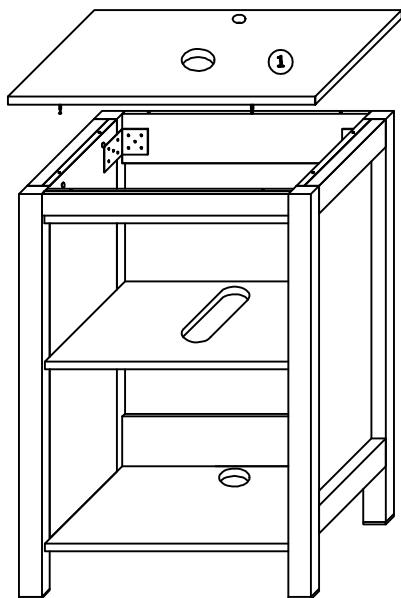
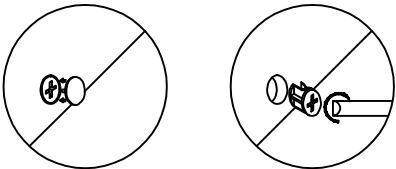

**STEP 7**

HARDWARE LIST		
A		6 PCS
C		6 PCS



**STEP 8**

HARDWARE LIST		
E		40 PCS
F		4PCS

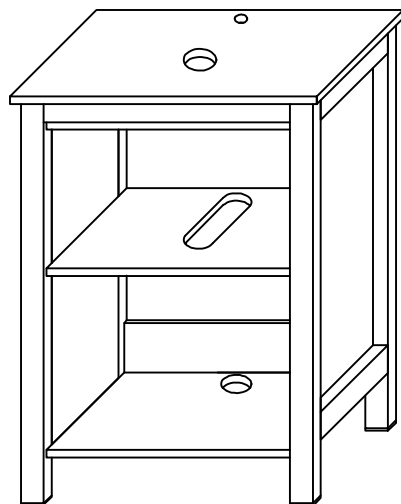
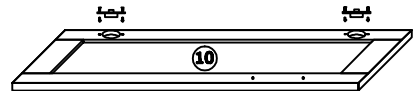
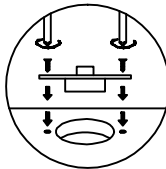

STEP 9

HARDWARE LIST	
E	1 16 PCS
G	4PCS
H	2PCS

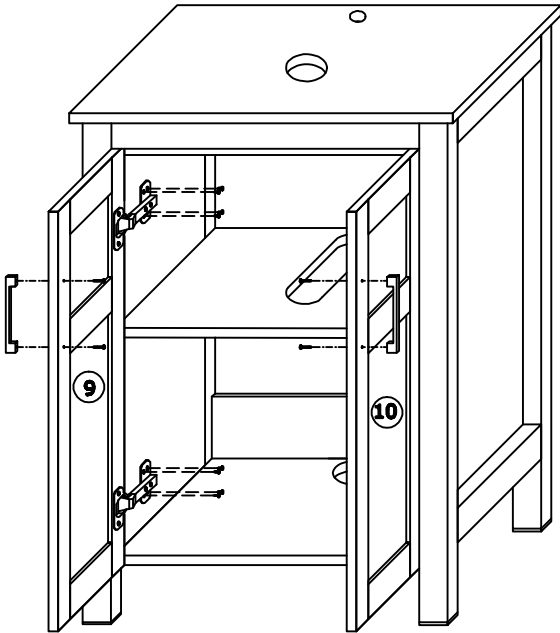
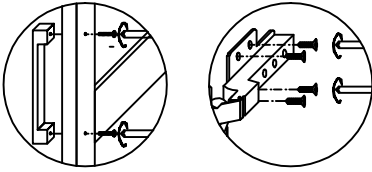

STEP 10

A. Height adjustment;  
 B. Depth adjustment;  
 C. Side to side adjustment.

HARDWARE LIST	

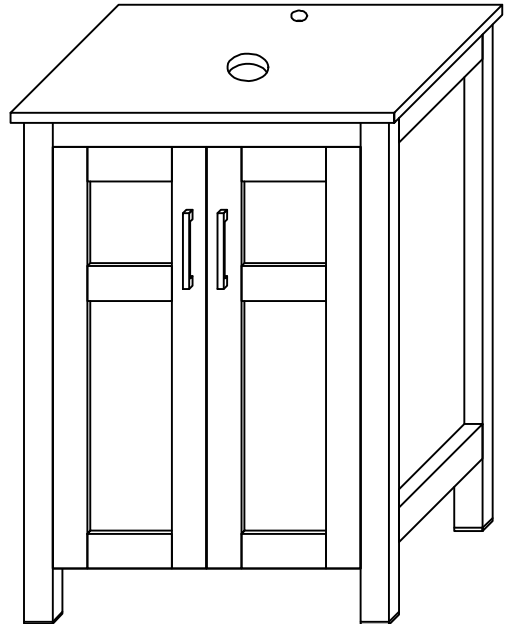
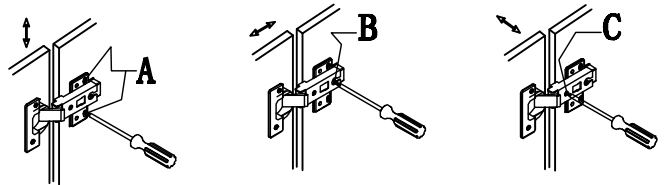

STEP 11

HARDWARE LIST	

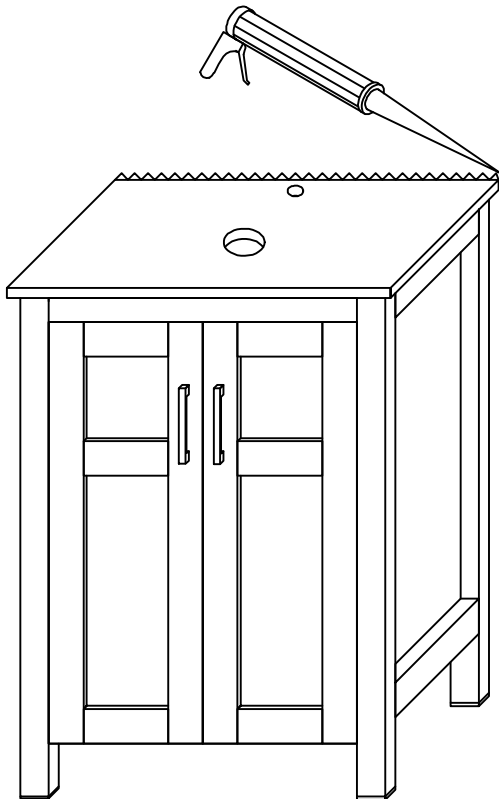

STEP 12

HARDWARE LIST	

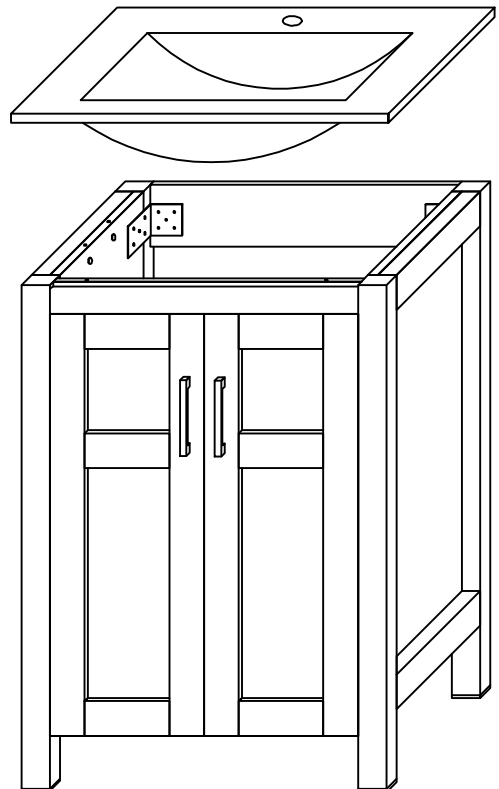

STEP 13

HARDWARE LIST

STEP 14

HARDWARE LIST

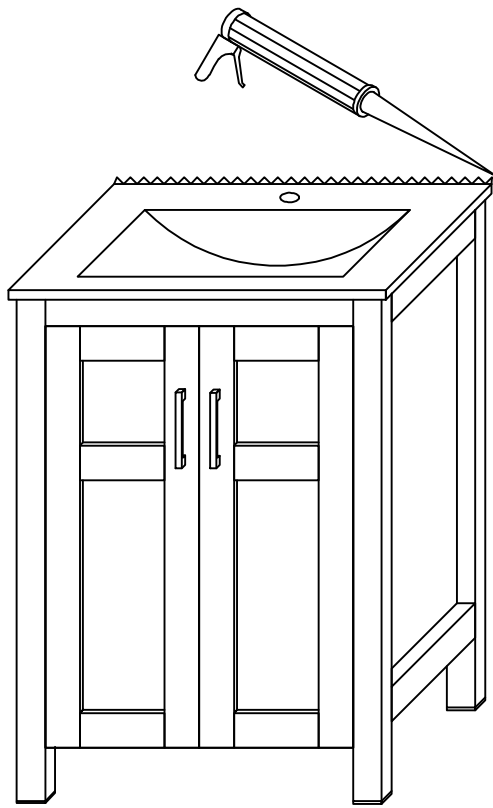

STEP 15

HARDWARE LIST

STEP 16

HARDWARE LIST