

# Assembly Instructions

**Caution : You must read this before you proceed**

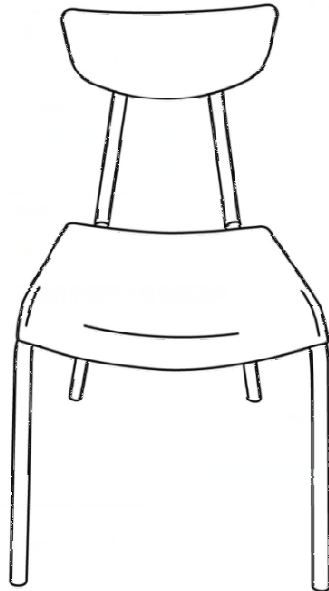





## Chair



## Parts List

Label	Picture	Description	QTY
A	A line drawing of the chair seat, which is a wide, flat, trapezoidal shape.	Chair Seat	1
B	A line drawing of the left armrest, which is a curved piece with a small hole at the top and a small notch at the bottom.	Left Armrest	1
C	A line drawing of the right armrest, which is a curved piece with a small hole at the top and a small notch at the bottom, mirroring the left armrest.	Right Armrest	1
D	A line drawing of the chair backrest, which is a wide, curved, bowl-shaped piece.	Chair Back	1

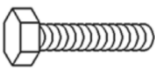
# Hardware

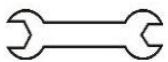
Label	Picture	Description	QTY
①		Bolt (M6*20MM)	5
②		Washer (M6)	5
③		Spring Washers (M6)	5
④		Allen Key	1
⑤		Bolt (M8*20MM)	5
⑥		Washer (M8)	5
⑦		Spring Washers (M8)	5
⑧		Spanner	1

# Assembly Preparation

Before Beginning Assembly:

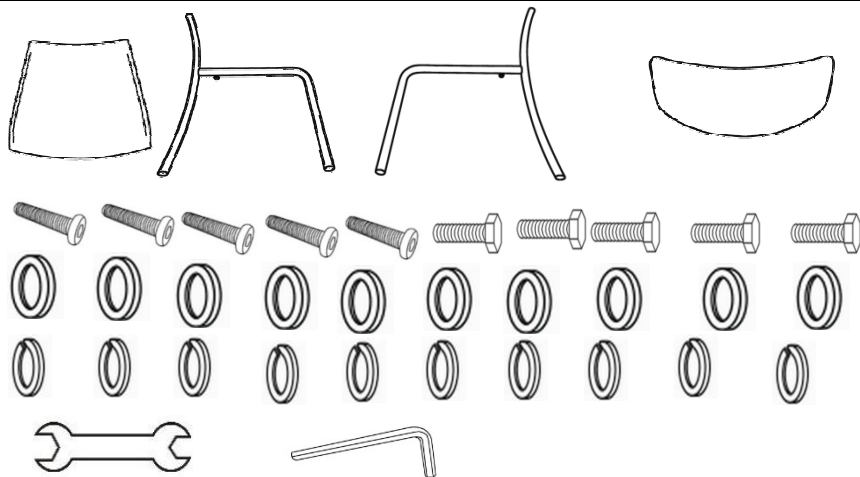

- Read instructions, cover to cover-



- Have 2 adults on hand for assembly-



- Do not assemble on flooring or carpet-



- Assemble on a clean non-marring surface (packing foam)-



- Save all packaging until finished-

# Assembly Steps

## Overview

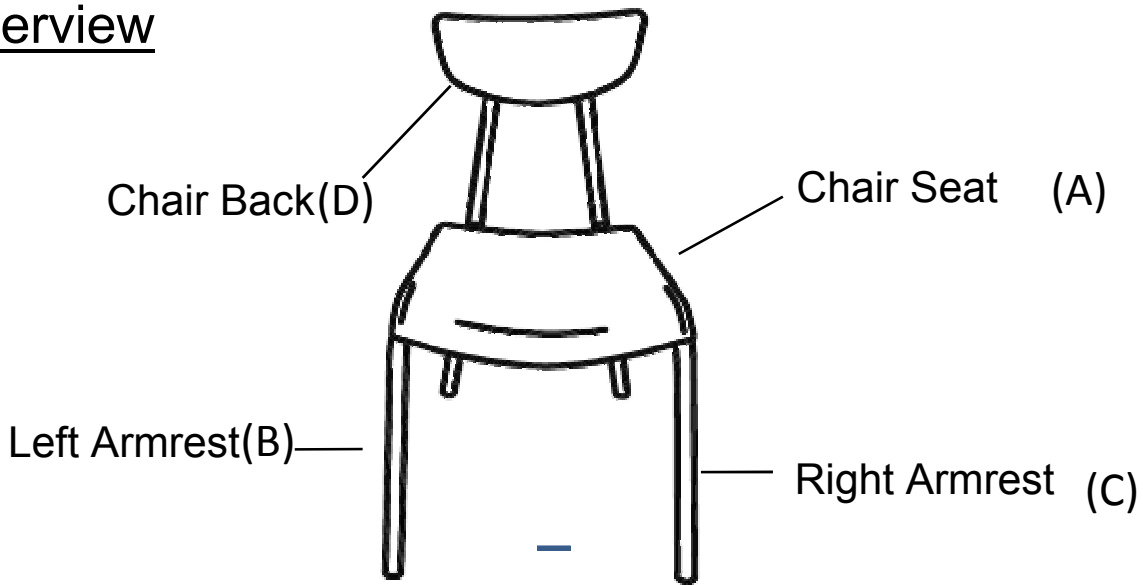

This Chair has multiple parts and may require up to 30 minutes or more to assemble. To give you an overview of the Chair, the above picture is to help you put the various parts into perspective. Please read through the instructions below to familiarise yourself with the parts and steps before assembly.

## Step 1

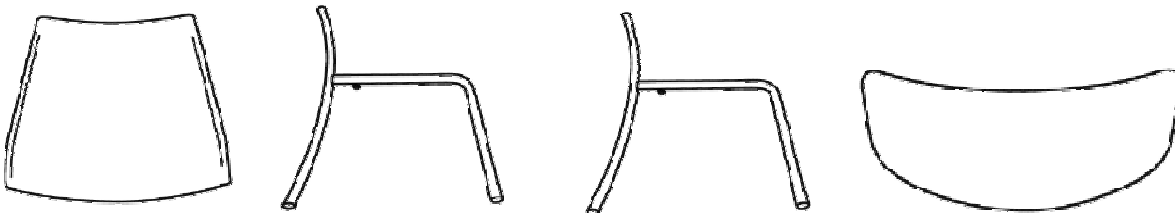

Unpack and place all parts on a clean, non-marring surface.

## Step 2

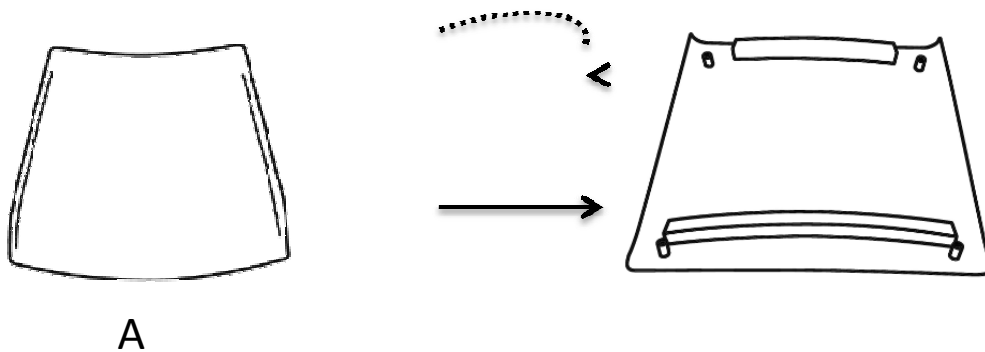

Place the Chair Seat(A) facedown as shown above.

### Step 3

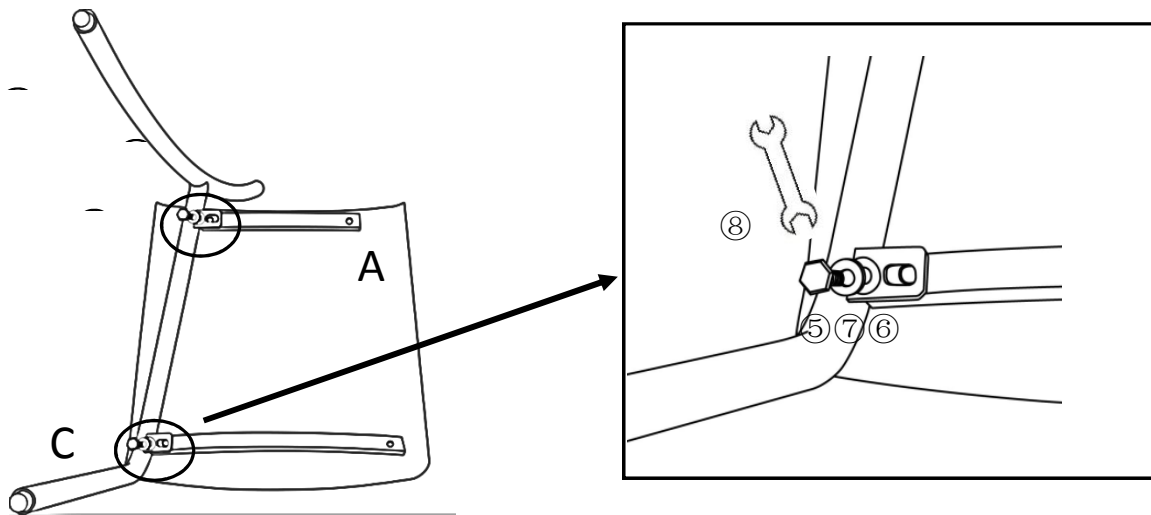

Align the mounting positions on Right Armrest(C) and Chair Seat(A), then attach using Bolts(5), Washers(6) and Spring Washers(7) with Spanner(8).  
**Do not fully tighten the Bolts.**

### Step 4

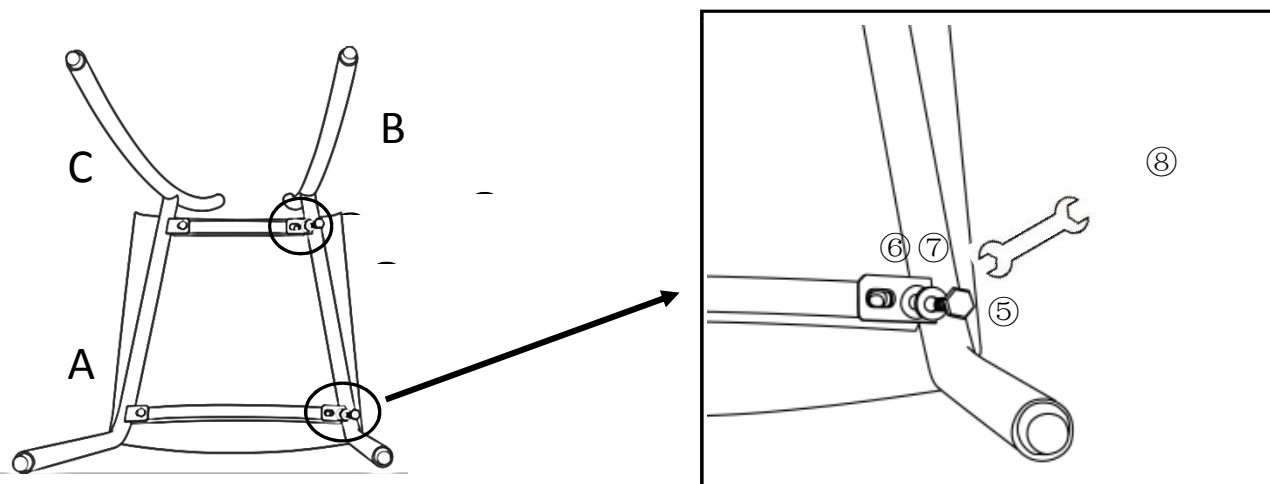

Align the mounting positions on Left Armrest(B) and Chair Seat(A), then attach using Bolts(5), Washers(6) and Spring Washers(7) with Spanner(8).  
**Do not fully tighten the Bolts.**

## Step 5

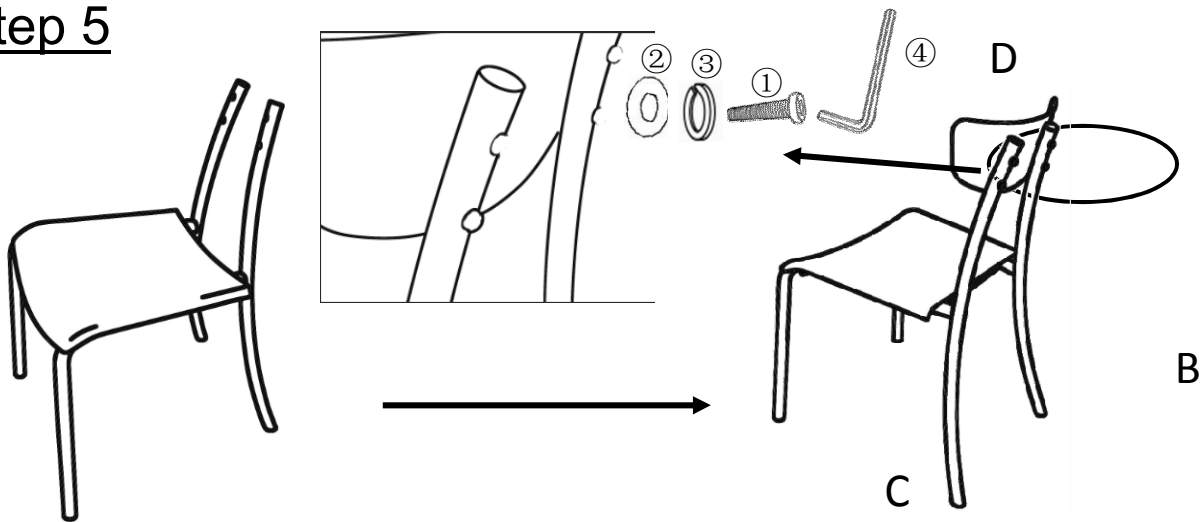

Stand the Chair up.

Align the mounting positions on Left Armrest(B),Right Armrest(C) and Chair Back(D),then attach using Bolts(①) ,Washers(②) and Spring Washers(③) with Spanner(④).

Carefully and gently sit into the Chair, this action will ensure there are no gaps between the parts.

**Then proceed to tighten all Bolts at all joints in a sequential manner.**

## Step 6

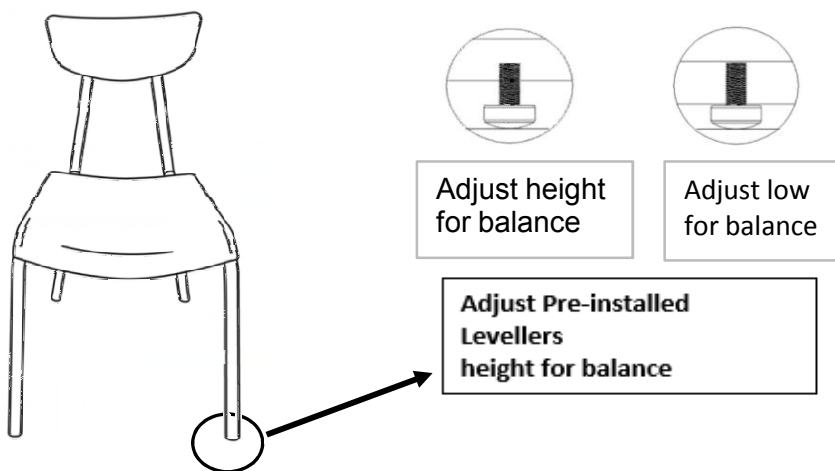

Adjust the Pre-installed Levellers at the base of the Legs until the Chair is level to the ground.



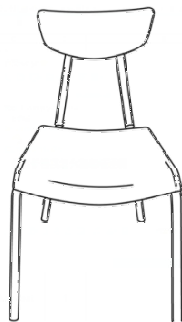





## Step 7



Your Chair is ready for use.

**This Chair can only be used on a flat, level surface.**

## Care & Maintenance

- ⊘  • Do not put hot items directly on furniture surface.
  - ⊘  • Do not clean furniture with harsh cleansers or polish.
  - ✓  • To obtain the longest lifespan of your outdoor products, minimizing exposure to direct sunlight is recommended.
  - ⊘  • Children should not climb or jump on the furniture.
  - ⊘  • Do not write on furniture without a padded barrier to protect the surface.
  - ✓  • To obtain the longest lifespan of your outdoor products, avoid extended and lengthy exposure to rain, snow, and direct sunshine. Whenever possible cover the product and /or place under patio or awnings.
  - ⊘  • Not for commercial use. For residential use only .
  - ⊘  • Stains may be removed with mild soap solution and damp cloth.
- 
- ✓  • Dust and pick-up spills using a clean, non-colored, lint-free cloth .