







<b>A</b>		1pc	Body
<b>B</b>		1pc	Wedge back
<b>C</b>		1pc	Back cushion
<b>D</b>		1pc	Seat cushion
<b>E</b>		1pc	Transformer
<b>F</b>		1pc	Charger

① Pull the power input wire from the back of the body, connect with the transformer and charger.



② Find switch panel on the side of the seat cushion .

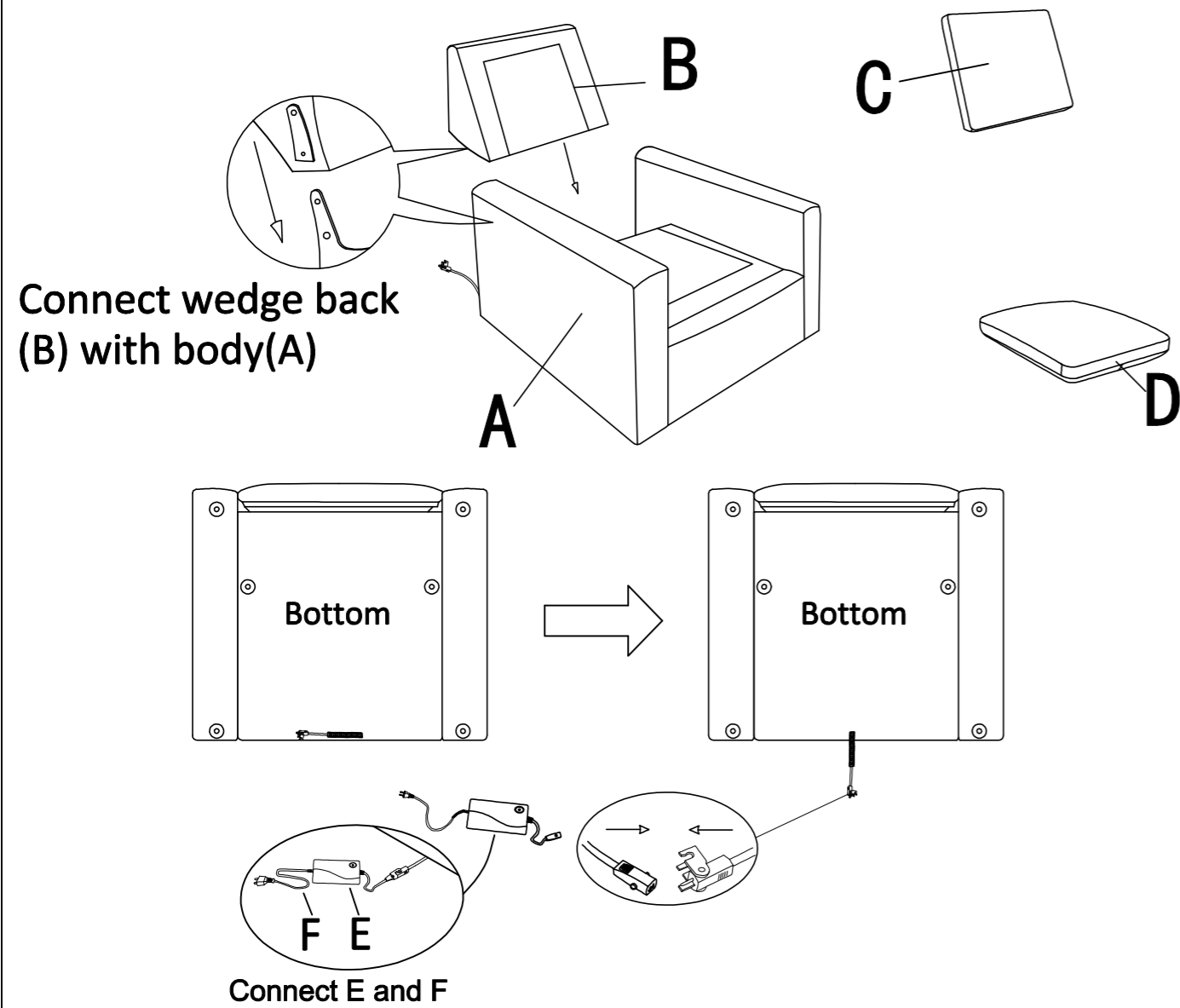
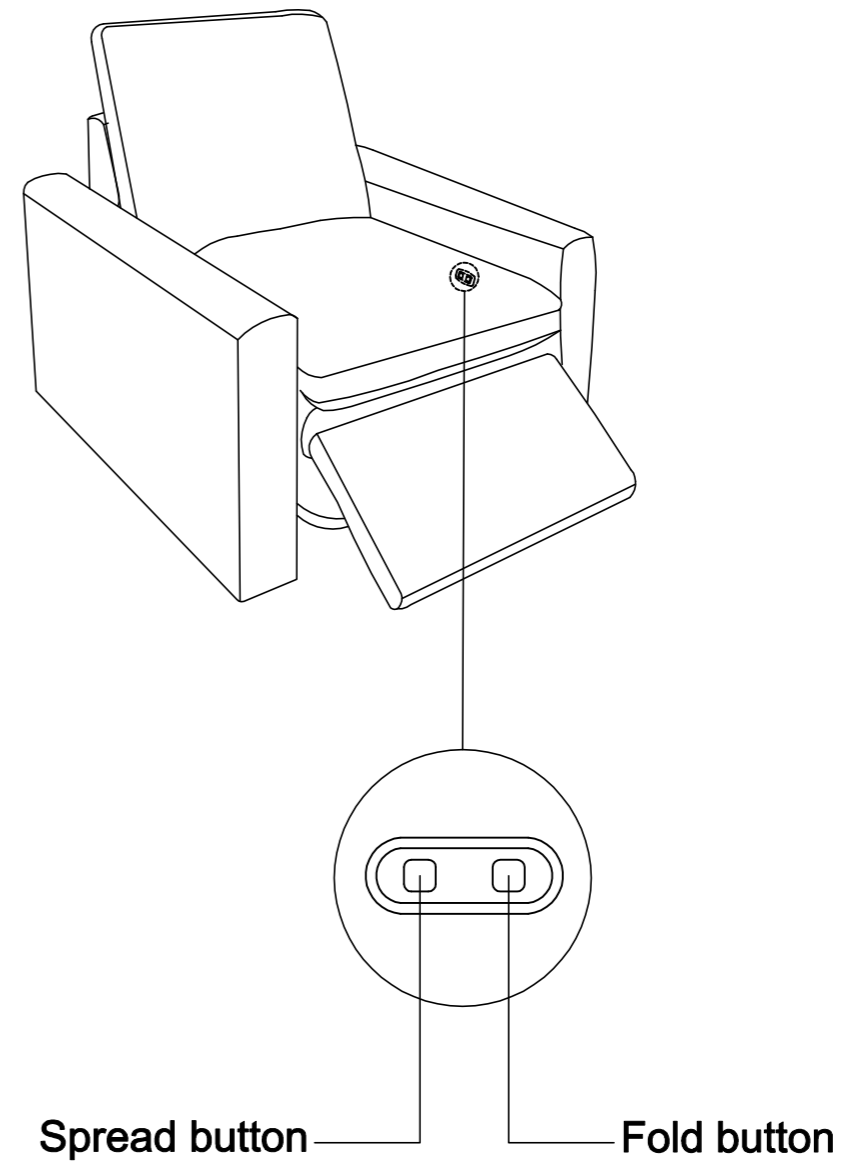

Product description: Power Recliner AI