

OWNER'S MANUAL

READ AND SAVE THESE INSTRUCTIONS

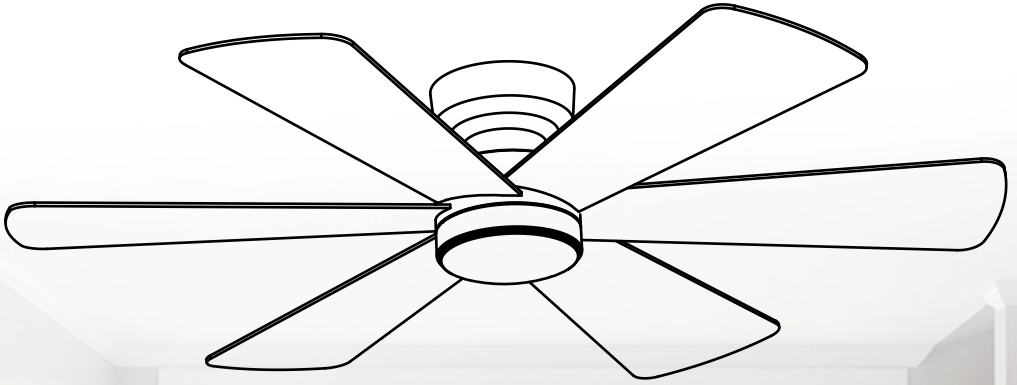

CONTACT INFORMATION

Feel free to reach out to us if you encounter any issue when using our products.

BRIEF CONTENT

Safety Precautions	1
Before You Start	2
Installing the Fan Blades.....	3
Installing the Light Kit	4-5
Installing the Mounting Bracket	6
Make the Electric Connections	7-8
Remote Control Setting and Operation	9
Important: Pairing Between Remote and Receiver	10
App Instructions	11
Protective Functions Of the Receiver	12
Maintenance.....	13

SAFETY PRECAUTIONS

The information contained in the following pages has been prepared to ensure your maximum enjoyment of your fan.

Please remove the fuse or turn off the circuit breaker to cut off the power before installing the fan. Ensure all electrical connections are in compliance with local laws, regulations and national electrical codes. If you are not familiar with electrical installation and wiring, please hire a qualified electrician or consult the wiring manual.

1. For your safety, all electrical connections and disconnections should be performed by a qualified electrician.
2. Any action performed for the electrical connection of the device must be carried out after ensuring that the general power supply is disconnected, by removing the corresponding fuse or disarming the protective switch in order to ensure total isolation of the power supply.
3. When deciding where to mount the fan, be sure that there is at least 30 inches (76 cm) of space between the fan and any wall or other obstruction that the fan blades could collide with. The greater this distance, the more effective the air flow produced. After the fan is mounted, be sure that the blades are no less than 7ft (2.1 m) above the ground.
4. The anchor point for the fan must be able to support a weight of at least 100 pounds (45 kg). If mounting on a ceiling junction box, be sure that the fan is adequately supported to prevent loosening or turning.
5. The fan's electrical connection must be completed (the fan's ground cable connected to the installation's grounding network) in order to avoid any branching that may be dangerous to people.
6. Connect the receiver of the fan light first. Do not connect the fan's power supply to any dimmers, potentiometers, as it will damage the motor. The fan's must be directly connected to a properly protected installation circuit (magnetothermal differential switch with the adequate size for the fan's consumption and technical specifications). Only use the fan's control to turn it on or stop it.
7. It is recommended to not use these types of fans along with gas installations simultaneously in the same room.
8. The fan must not be moving and must have come to a complete stop before changing its direction of rotation. This will prevent damage to its motor and to the control unit, when applicable.
9. Do not insert anything that could hit the fan's blades into its pathway while it is moving, as this could cause damage to people, can damage the blades, and can offset the balance of the unit, causing vibrations and wobbling.
10. After installing the fan, ensure that all fastenings are secure and tightened in order to avoid any noise caused by loose elements.
11. Due to the fan's movement, certain fastenings may become loose. Check all fastenings twice per year at a minimum in order to ensure that they are sufficiently tight. If necessary, they must be retightened.
12. The motor housing can be cleaned with a soft brush or a lint-free cloth to avoid scratching the surface. Clean the blades with a lint-free cloth. Important: Turn off the main power supply before starting any maintenance. Do not clean the fans with water or a damp cloth.

BEFORE YOU START

Contact a licensed electrician if you are not good at performing electrical work. If required by the local code, do not use the fan with a dimmer switch. Turn off power at breaker

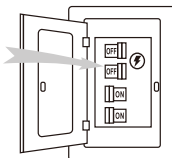

Tools and Materials Required



External Hexagonal Wrench



Wire Stripper



Phillips Screwdriver



Step Ladder

BEFORE YOU START

Product Instruction

Mounting Bracket → 

Screws → 

Canopy → 

Fan Motor Assembly → 

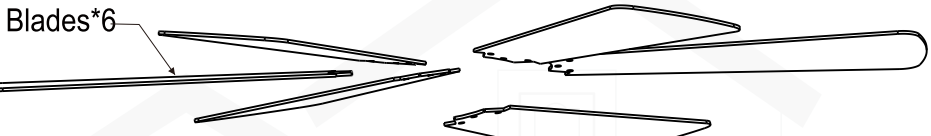

Blades*6 → 

Screws for Blade*18 → 

Lamp panel → 

Lighting Base screws → 

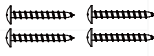
Lamp Shade → 

Item no.	Reference Image	Qty.
1	 ST5x35 Setscrew	x4
2	 Expansion Screw	x2
3	 Screws for Blades	x18

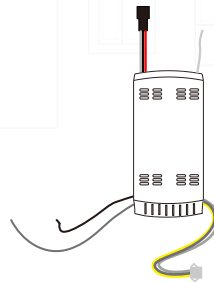

Receiver



Remote Control

Installing the Fan Blades

1: Install Canopy onto the motor

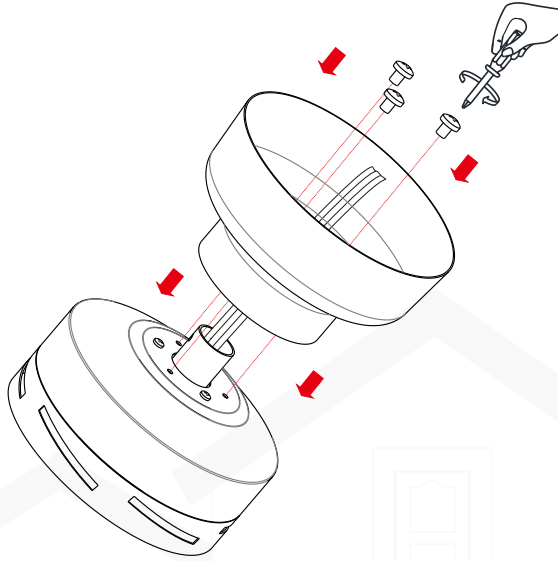

(Figure 1)

2: Remove the screws locked on the side of the motor, pass the fan blades through the motor side holes, and install the fan blades onto the motor with screws

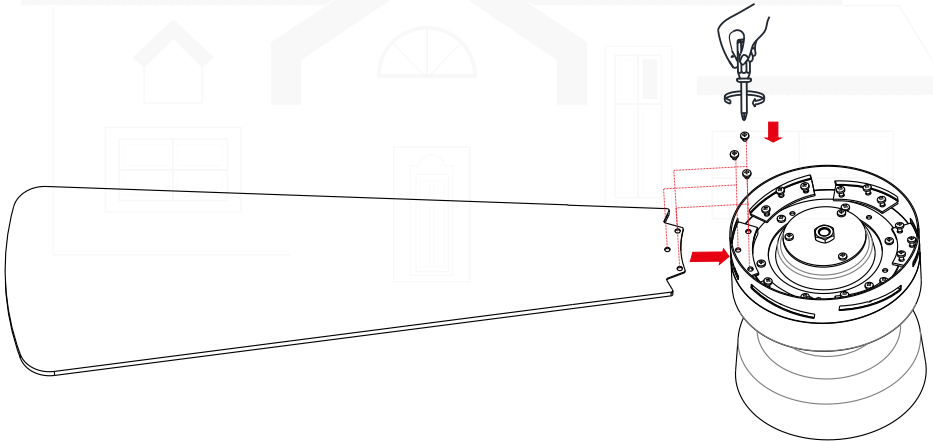

(Figure 2)

Installing the Light Kit

3: Remove the lampshade and light source from the light source box in sequence, and set them aside for future use

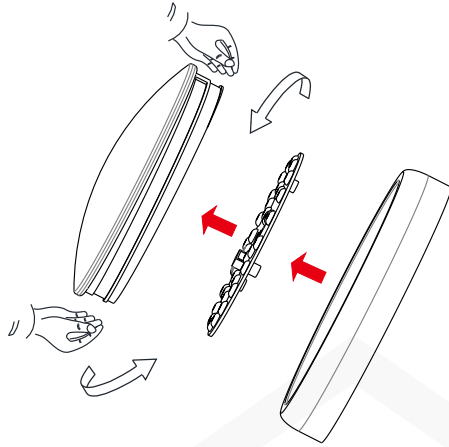

(Figure 3)

4: Remove the screws at the bottom of the motor in sequence and install the light source box onto the motor

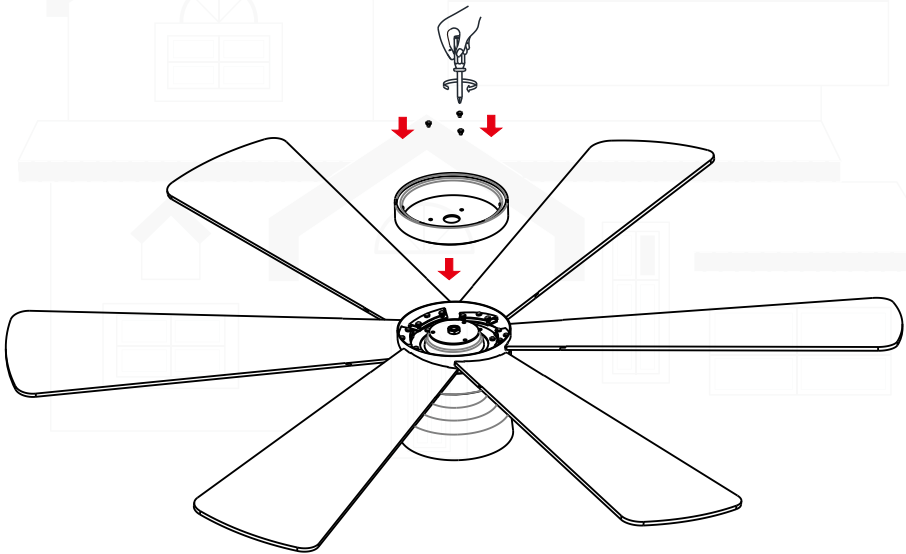

(Figure 4)

Installing the Light Kit

5: Insert the power cord through the LED patch light source and connect it to the LED patch light source. Fix the LED patch light source upwards onto the lamp body

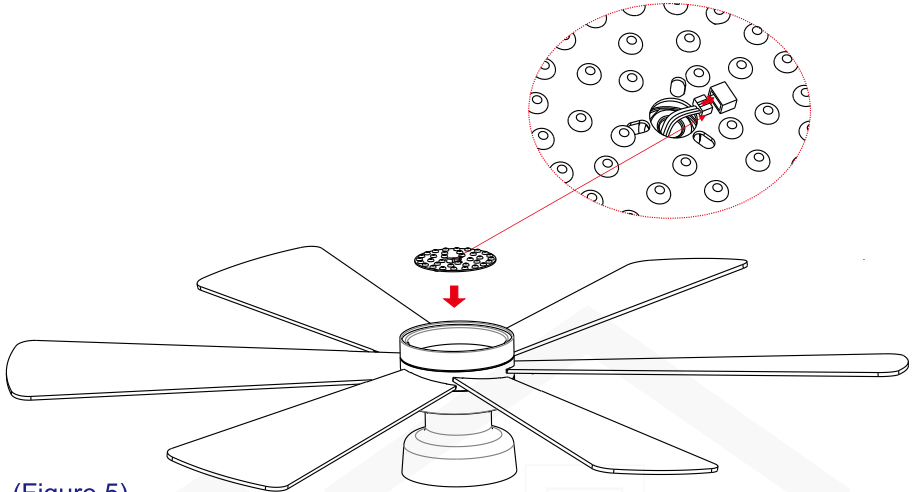

(Figure 5)

6: Installing Lamp shade

⚠ WARNING Take care not to over tighten when installing the glass shade

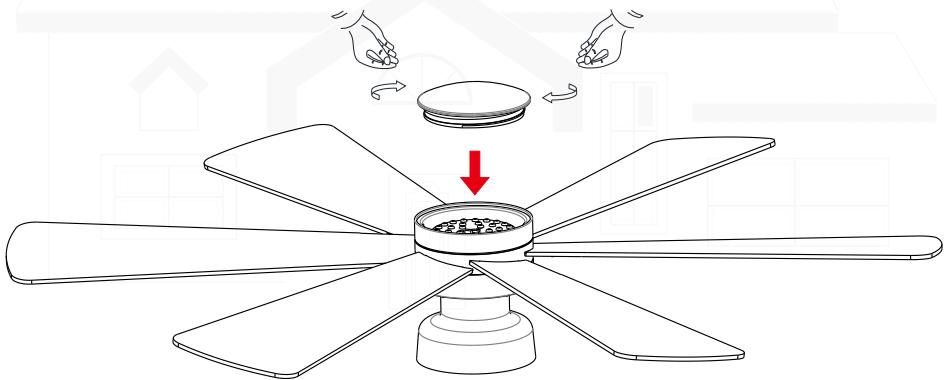

(Figure 6)

Installing the Mounting Bracket

Tools Required : Phillips screwdriver , a pair of pliers , straight slot screwdriver , adjustable wrench , step ladder ,and wire cutters

INSTALLING THE MOUNTING BRACKET

The ceiling fan must be installed in the location where there is 12"(300mm) spacing from the tips of all blades to the nearest objects or walls. REMEMBER to turn off the power before hanging the fan. Follow the instruction below to hang your fan properly:

1. For concrete ceiling, drill two holes in the ceiling and secure the mounting bracket to the ceiling with two $\Phi 0.32"$ (8mm) (distance between the two holes should be appropriate) expansion screws, flat washers nuts provided and tighten with a spanner.

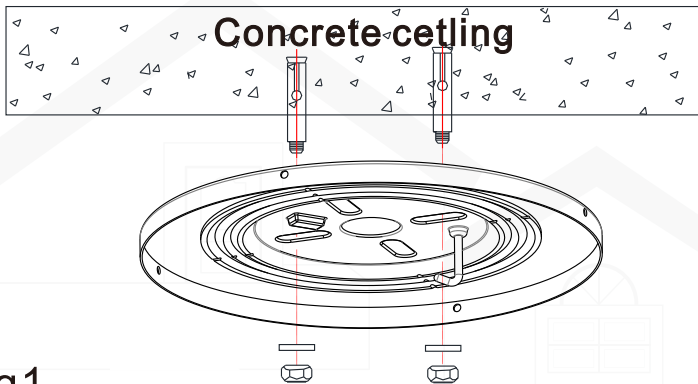

Fig1

2. For wood ceiling, secure the mounting bracket to the ceiling that is capable of carrying a load of at least 100lbs (45kgs) with two long mounting screws and washers provided. Be sure at least 0.12"(30mm) of the screw is threaded into the support.

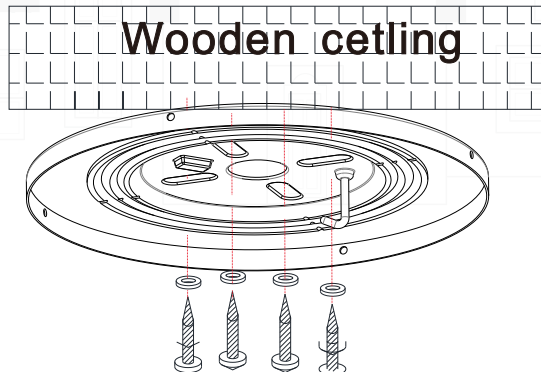
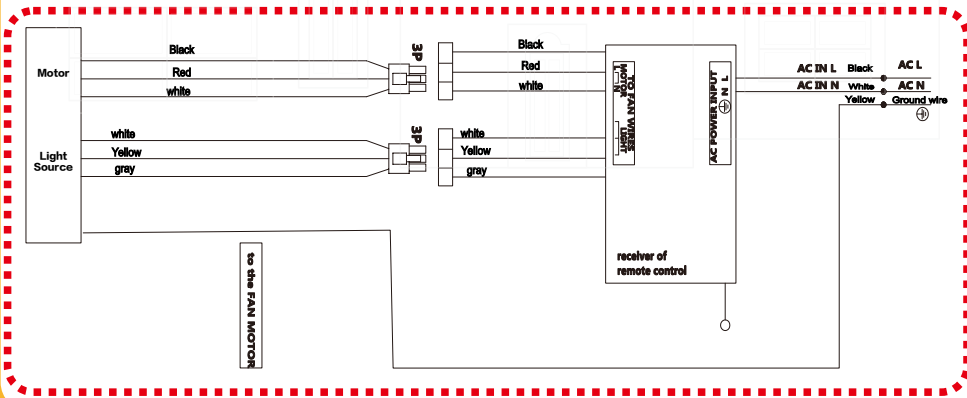
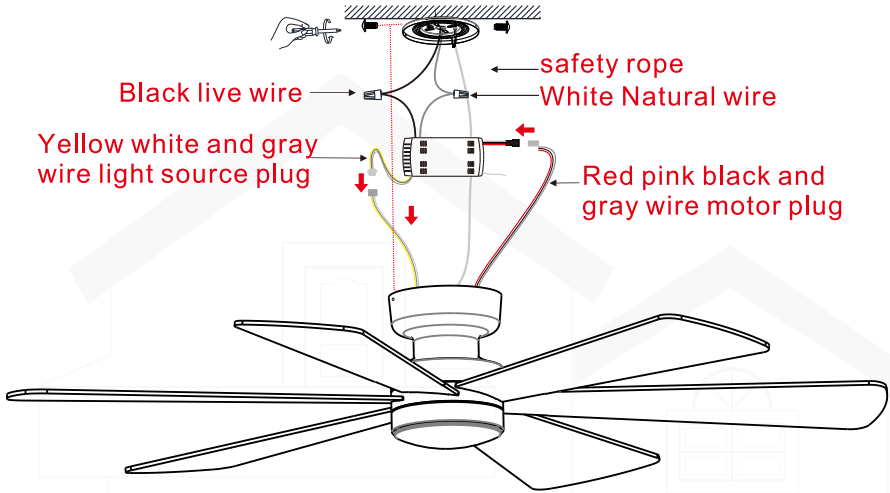

Fig2

Make The Electrionnections

⚠ WARNING To avoid possible electrical shock , be sure the electricity is turned off in the main fuse box before wiring

- 1 . Connect the black wire on the motor to the live wire in the room, the white wire on the motor to the natural wire in the room, and connet the yellow ground wire on the ceiling mounting plate to the ground wire in the room
2. Connect the same color wire on the receiver and fan body together
3. After wiring is completed , fix the fan lamp body onto the hanging board with screws



Make The Electric Connections

Installation is now finished . Turn on the power switch. Then the fan lights are on Test and pair your fan immediately using the remote control

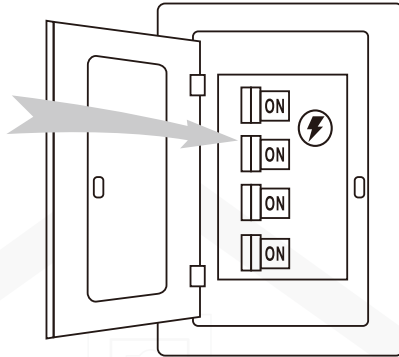

Remote Control Setting and Operation

1. Restore electrical to the outlet box by turning the electricity on at the main fuse box.
2. Remove the battery cover from the remote control transmitter, install the battery, and replace the cover.
Note:
 - 1). Use AAA 2 1.5V battery to replace battery.
 - 2). If not using for long periods of time, remove the battery to prevent damage to the remote transmitter, and store the remote transmitter away from excess heat or humidity.
3. The buttons on the remote control transmitter control the fan speed and light as follows.

Remote Control (Esmmitter) Operation

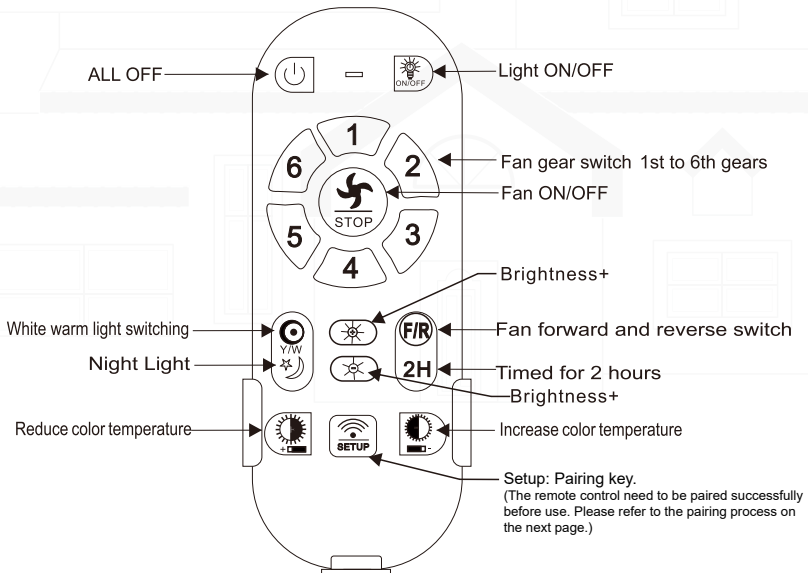
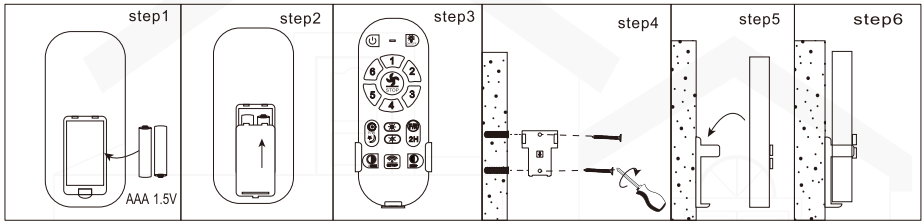

Important : Pairing Between Remote and Receiver

Within the 3s after turning "ON" the power supply, long press the Remote Control "Setup" button for 3-5 seconds. If the fan light flashes 2/3 times, then the pairing is successfully done and all functions will work normally.

IMPORTANT:

pairing initial step must be performed within 30 seconds of power being turned on.

1(a). when pairing multiple fans please ensure the isolation switch or power supply to the first installed fan is turned off prior to pairing further fans e.g please pair one fan at a time

1(b). please ensure isolation switch is kept to the ON position, the isolation switch is not to be used as a light switch as this will damage and make the remote receiver inoperable

2. If the transmitter functions are not working please check the battery orientation and power level. Low battery voltage will affect the functions of your transmitter and operation of your fan. Other remote controls nearby using the same frequency may cause interference with the Fans receiver.

3. Please remove batteries from the transmitter if leaving unused for an extended period of time.

4. Remote supports 200w maximum on lighting side.

IMPORTANT REMINDERS

1. Please note: Receiver must be correctly installed in the mounting bracket on fan

2. When the transmitter cannot control the receiver, please check the battery has sufficient charge in the transmitter.

3. When the transmitter cannot control the receiver, please check if there is any existence of similar remote controlled products nearby, causing interference with each other.

4. Low power of battery will affect the sensitivity of the transmitter and the signal reception accordingly, must replace if the battery is getting low power.

5. Please take the battery out from the transmitter when leaving unused for a long time, to avoid battery leaks.

6. Isolation Switch "Must be connected in the line."

7. When power is cut to the unit (via a blackout or otherwise) when power is restored the light will come on.

Before carrying out any cleaning or maintenance work, always make sure that the appliance is disconnected. LED lights are not removable. LED lights can only be used within the product delivery, they can not be replaced.

APP Instructions



Note

Note: If your APP interface is displayed in Chinese, click the menu in the upper left corner to switch languages.

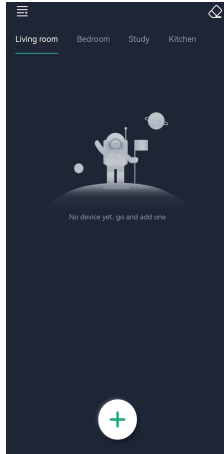

Step 01

Step 1: Click "+" button to set the name of your fan light.

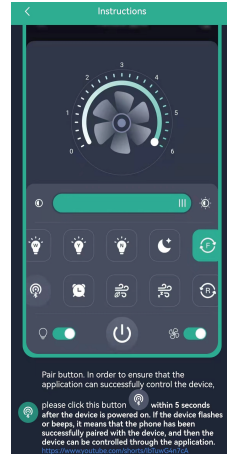

Step 02

Step 2: Click the pair button 1-2 times within 5 seconds after the fan is powered on. If the fan light flashes or beeps, it means the phone has been successfully paired.

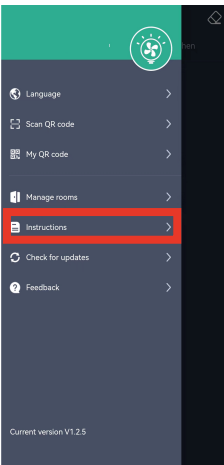

Instruction 01

Click the "Instructions" you can see the introduction of all the buttons.

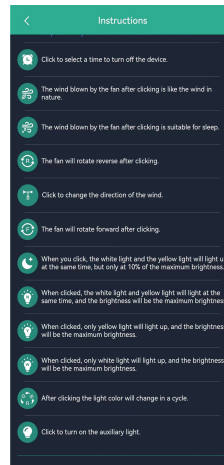

Instruction 02

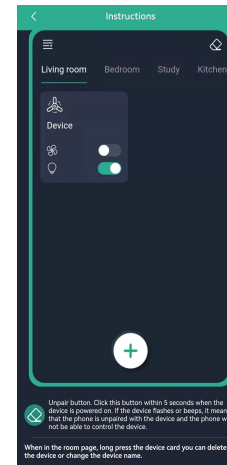

Instruction 03

Protective Functions of The Receiver

Lock protection- The DC motor has a built-in safety feature against blade or motor obstruction during operation. If something obstructs the fan blades or motor, the motor will keep trying to run and then stop operation after about 30 seconds of interruption. Please remove obstacles and reset. To reset: Turn the fan off by remote transmitter and then turn the fan on.

Over load protection (current limit)- The device will limit the maximum current output from the receiver/drive if the fan load has increased abnormally.

Tips

1. If your fan is operates automatically after installation and power on, it is because your fan has memorized the previous factory setting. Use the Universal Mode or the learning function and your fan will be ready for use.
2. If the fan or light isn't working, reset power (turn the power off for at least 5 seconds and then turn the power back on) and redo the learn function setting.
3. It is not possible to remotely operate more than one fan in the same room (in the area where the remote signal can reach to) if they share the same power supply. Separate power supplies (such as using individual wall switches for each fan) is required if you want to separately control more than one fan in same room.
4. When the fan is turned on or operated using forward/reverse function, it shutters & goes back & forth until it turns.
This is a normal and it will take a few seconds to run this operation.

1. Periodic cleaning of your new ceiling fan is the only maintenance that is needed.
2. When cleaning, use only a soft brush or lint free cloth to avoid scratching the finish.
3. Abrasive cleaning agents are not required and should be avoided to prevent damage to finish.

 **WARNING**

Do not use solvents when cleaning your ceiling fan. It could damage the motor and create the possibility of electrical shock.

RECOMMENDED:

Periodically check that the blade sets to the fan motor setscrews are secure and tight.

