

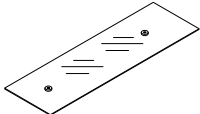







# ASSEMBLY INSTRUCTION FOR ACME FURNITURE



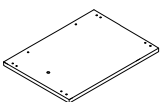
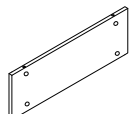
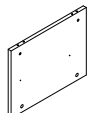





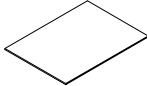
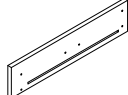
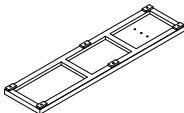
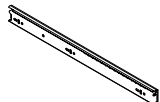

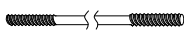
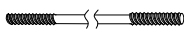

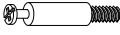

## MODEL# 91140 Tv Stand

Thank you for purchasing this quality product. Be sure to check all packing materials carefully for small parts which may have come loose inside the carton during shipment. Separate, identify, and count all parts and metal hardware. Compare with parts list to be sure all parts are present. If any part(s) are missing or damaged, please contact your local furniture dealer. For efficient and speedy service, please indicate the model number and code letter of the part(s) needed.

\*\*\* Do not fully tighten screws until fully assembled \*\*\*

COMPONENT PARTS		
DECERPTION	PART NAME	Q'TY(PCS)
①	Glass Top 	1pc
②	Glass Shelf 	1pc
③	Glass Top Support 	1pc
④	Glass Shelf Support 	1pc
⑤	Top Panel 	1pc
⑥	Box Back panel 	1pc
⑦	Box Side panel 	2pcs
⑧	Shelf Leg 	1pc
⑨	Drawer Back panel 	1pc

⑩	Drawer Left panel		1pc
⑪	Drawer Right panel		1pc
⑫	Drawer Bottom panel		1pc
⑬	Drawer Front Panel		1pc
⑭	Bottom panel		1pc
⑮	Drawer Rail		2pcs

<b>HARDWARE REQUIRED:</b>	
(A) 	Cap $\phi 47 \times 4$ - 1pc
(B) 	Rod $5/16" \times 17-7/8"$ - 1pc
(C) 	Rod $5/16" \times 9-1/2"$ - 1pc
(D) 	Nut M8 - 2pcs
(E) 	Big Washer - 2pcs
(F) 	Small Pin $\phi 6 \times 30$ - 8pcs
(G) 	Big Pin $\phi 8 \times 30$ - 2pcs
(H) 	Bolt M6x40 - 8pcs
(I) 	Nut $\phi 14.5 \times 11$ - 8pcs
(J) 	Bolt M6x24 - 12pcs
(K) 	Nut $\phi 12 \times 10.5$ - 12pcs
(L) 	Screw M4 - 8pcs
(M) 	Bolt $1/8" \times 7/8"$ - 2pcs
(N) 	Bolt $1/4" \times 1-1/8"$ - 2pcs
(O) 	Small Washer - 2pcs
(P) 	Knob - 1pc
(Q) 	Allen Wrench M4 - 1pc
(R) 	Socket Wrench M8 - 1pc

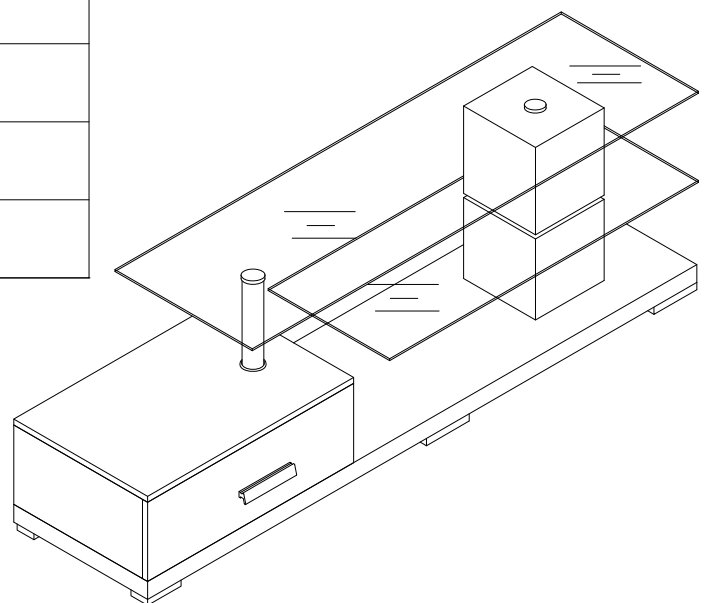

**Attention:**

\*\*\*Mattresses not included.

\*\*\*Some number parts listed on the instruction sheet may not be in parts bag as they may already be assemble.

Carefully check parts and packing materials prior to ordering replacements.

# How to Assemble:

## STEP 1.

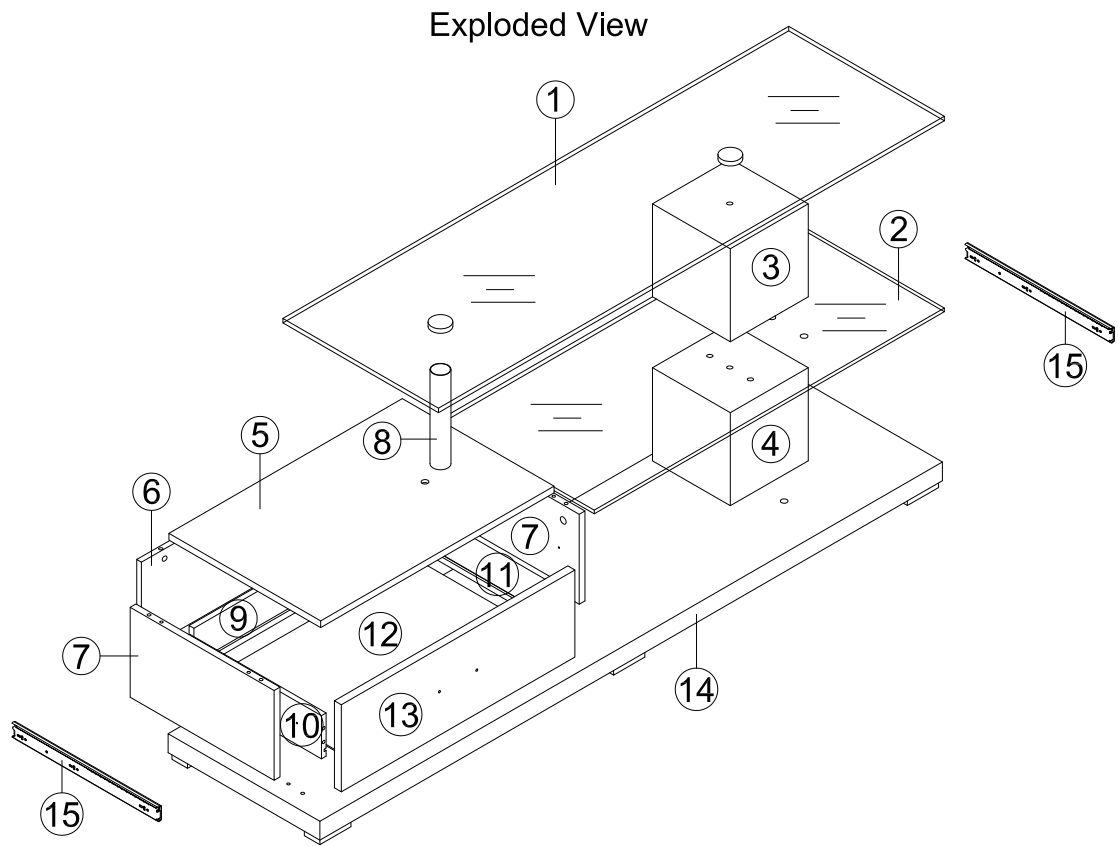

## STEP 2.

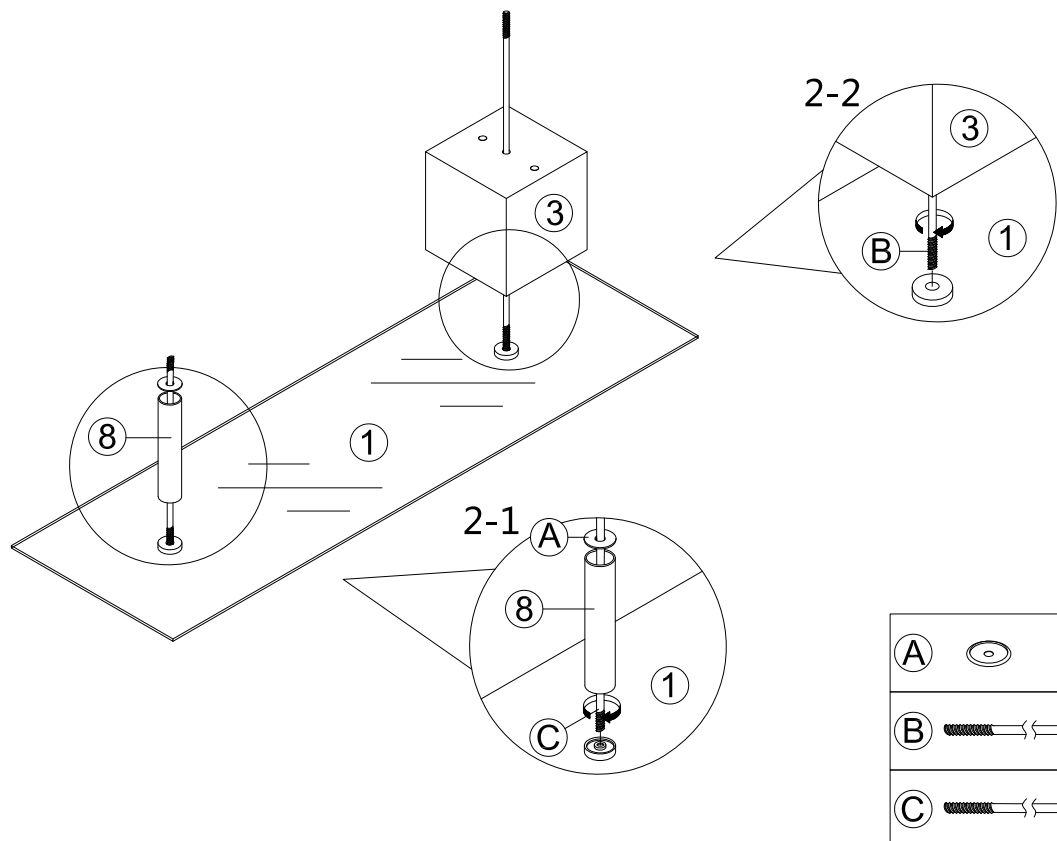

# How to Assemble:

## STEP 3.

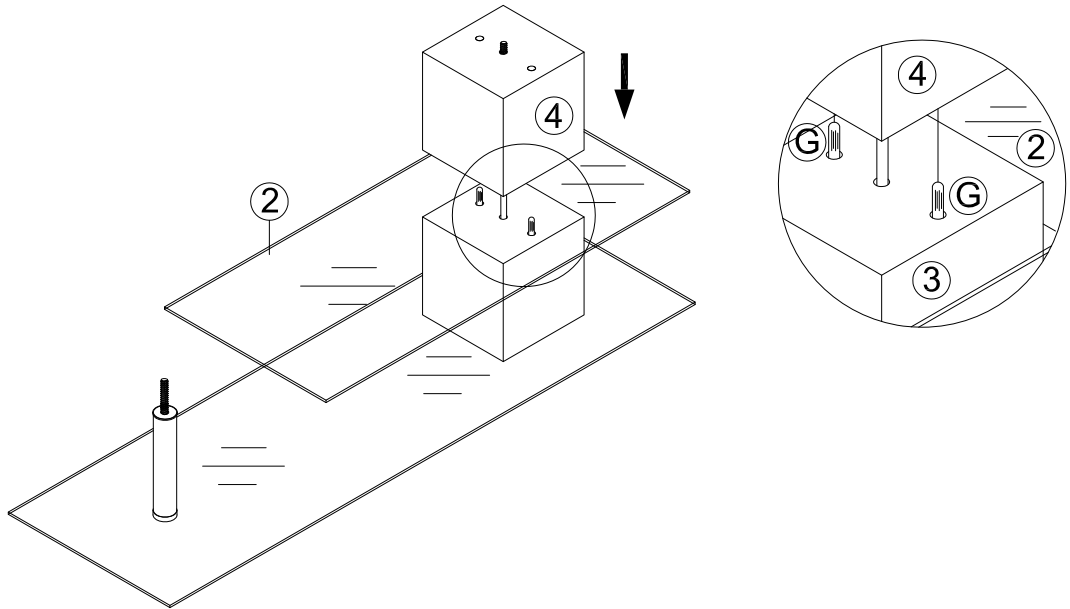

(G)  2pcs

## STEP 4.

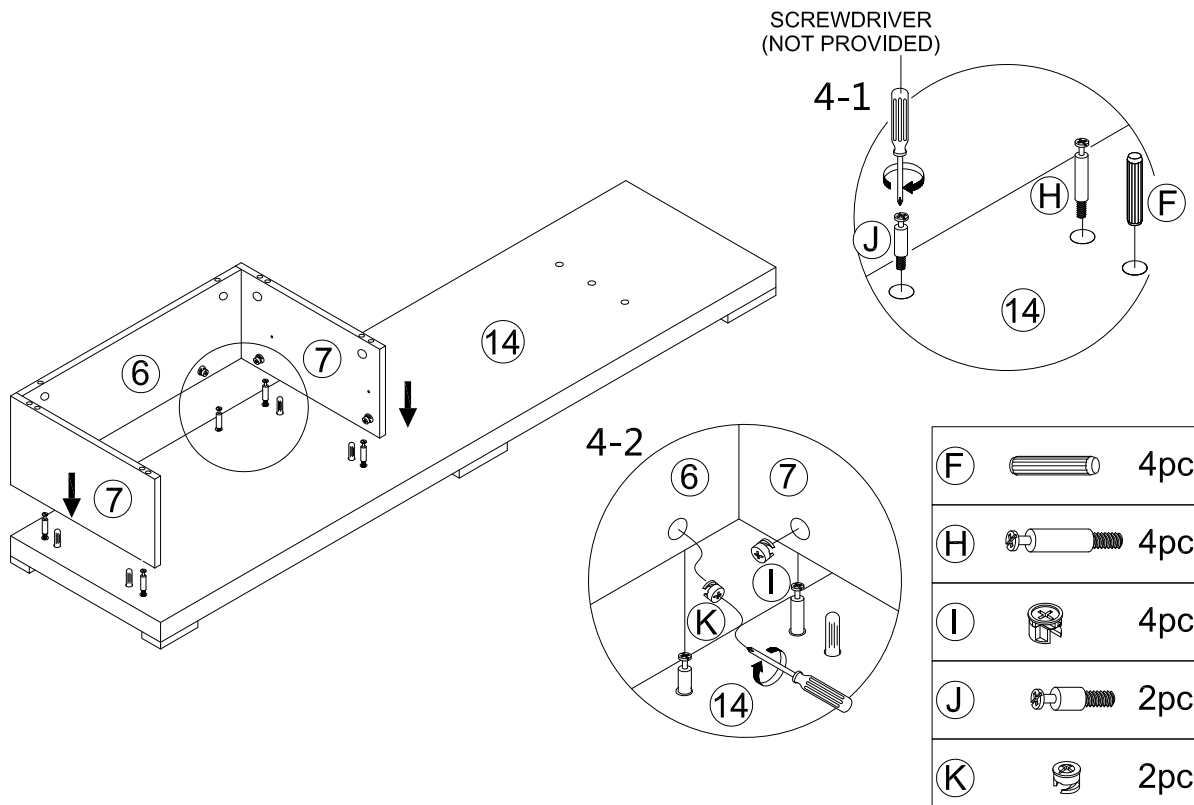

# How to Assemble:



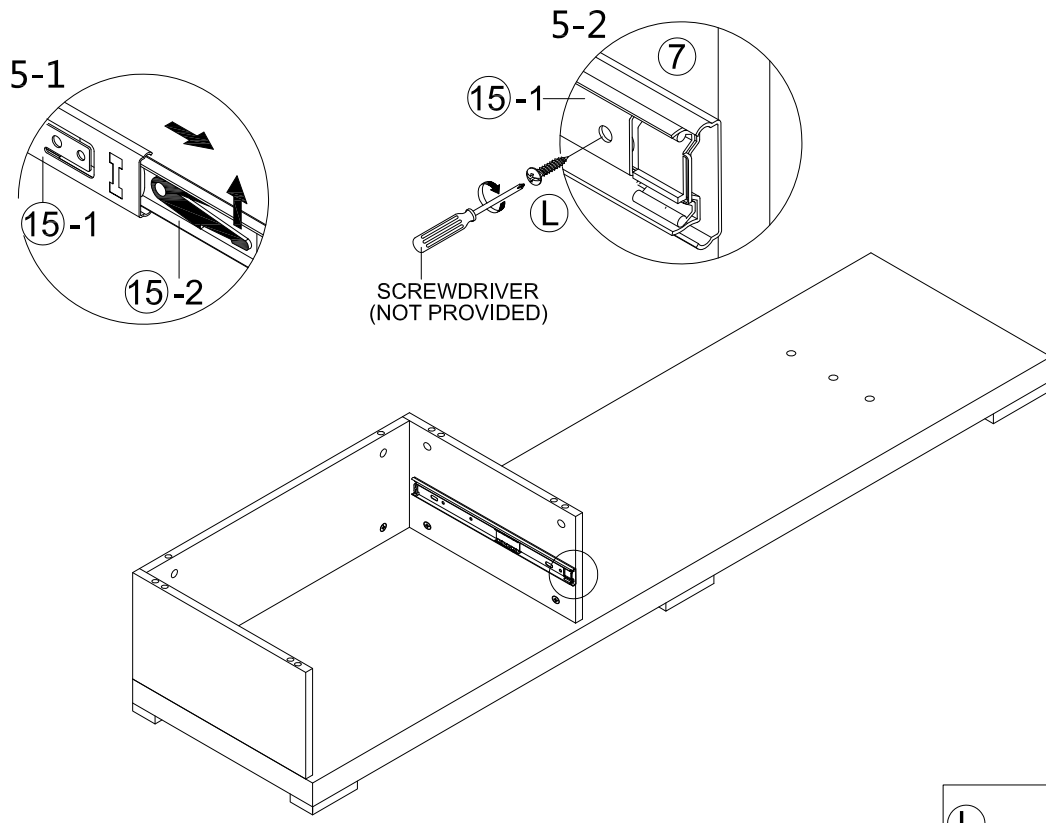

## STEP 5.

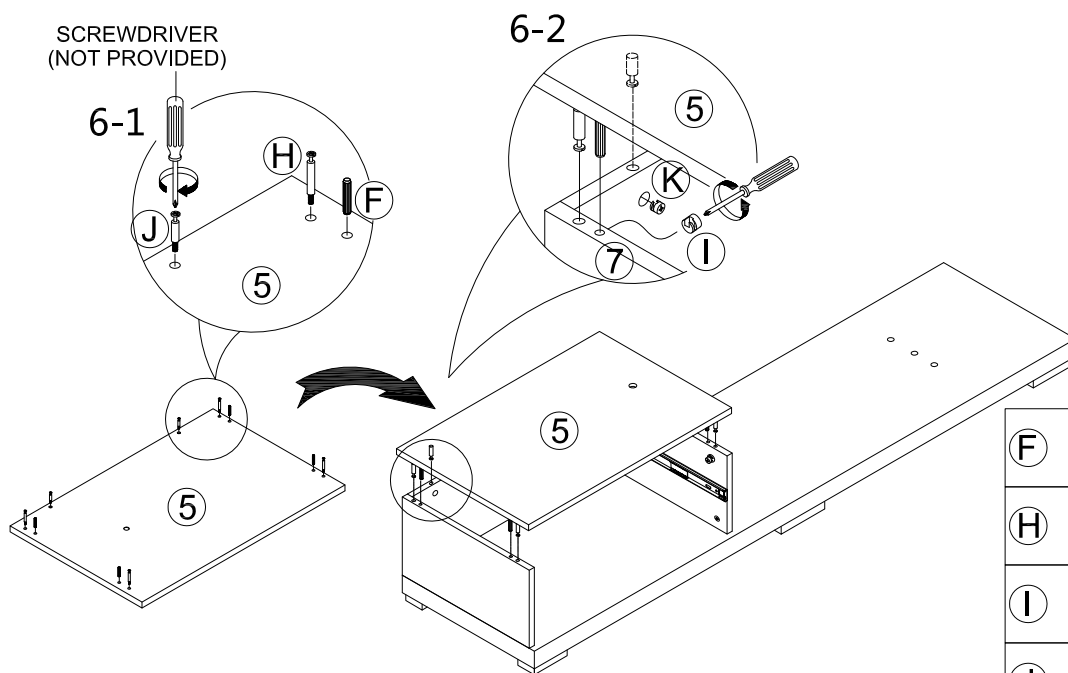

(L)  4pcs

## STEP 6.



(F)		4pcs
(H)		4pcs
(I)		4pcs
(J)		2pcs
(K)		2pcs

# How to Assemble:

## STEP 7.

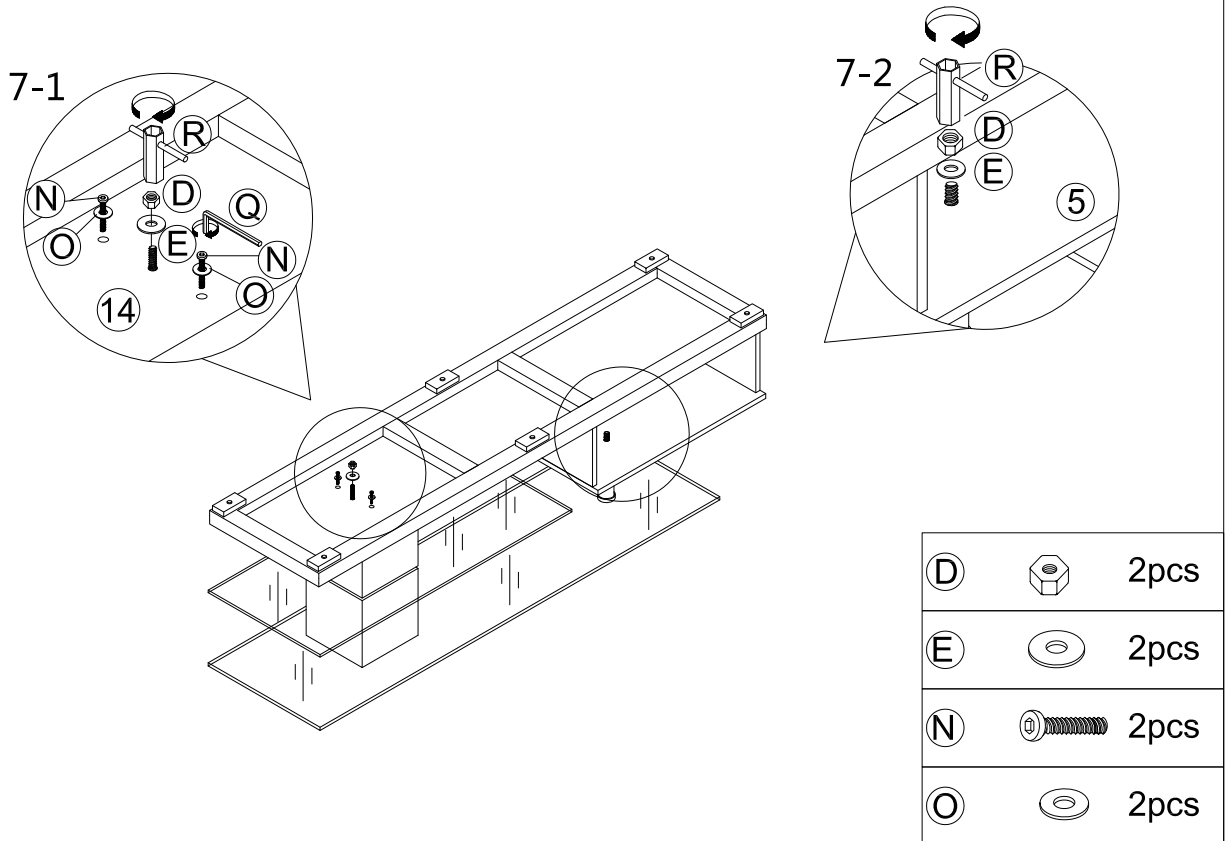

## STEP 8.

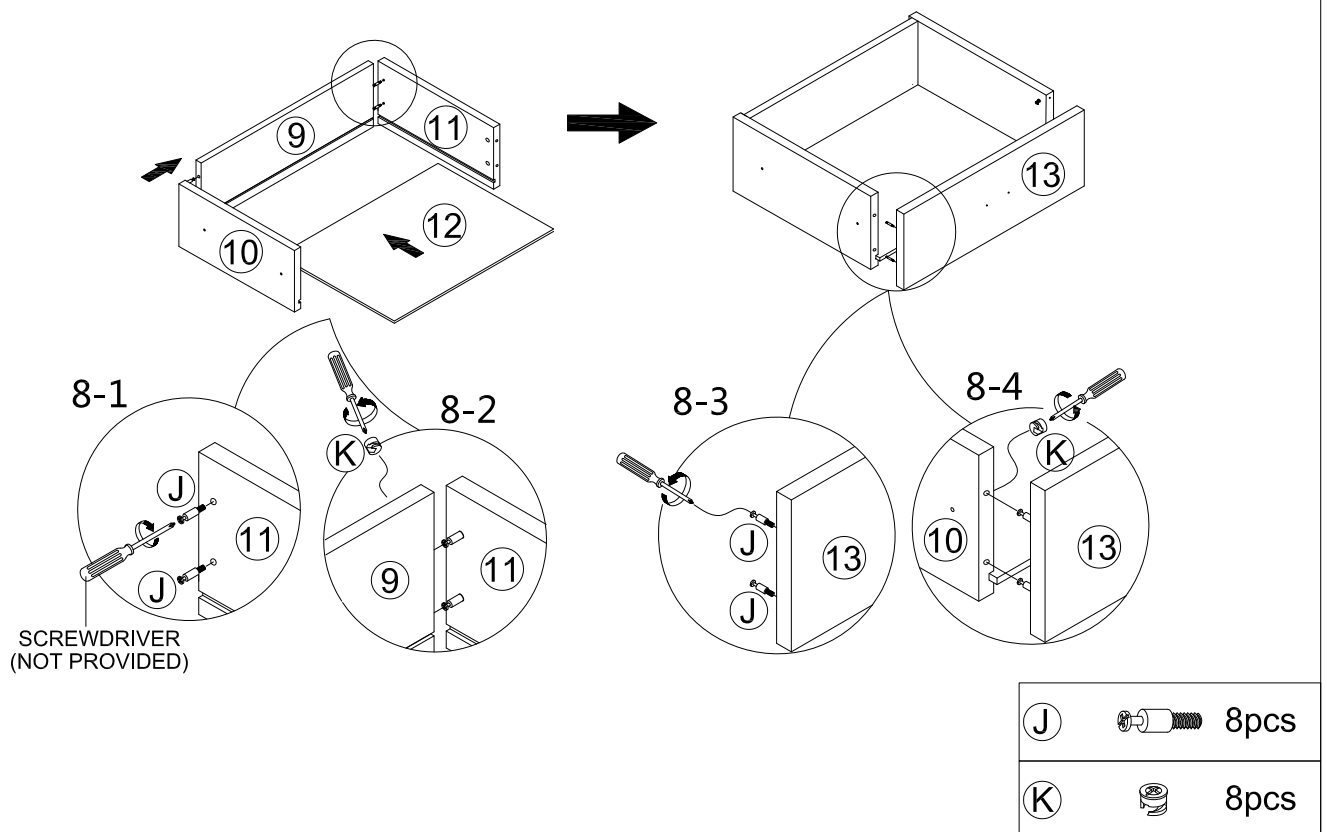

# How to Assemble:

## STEP 9.

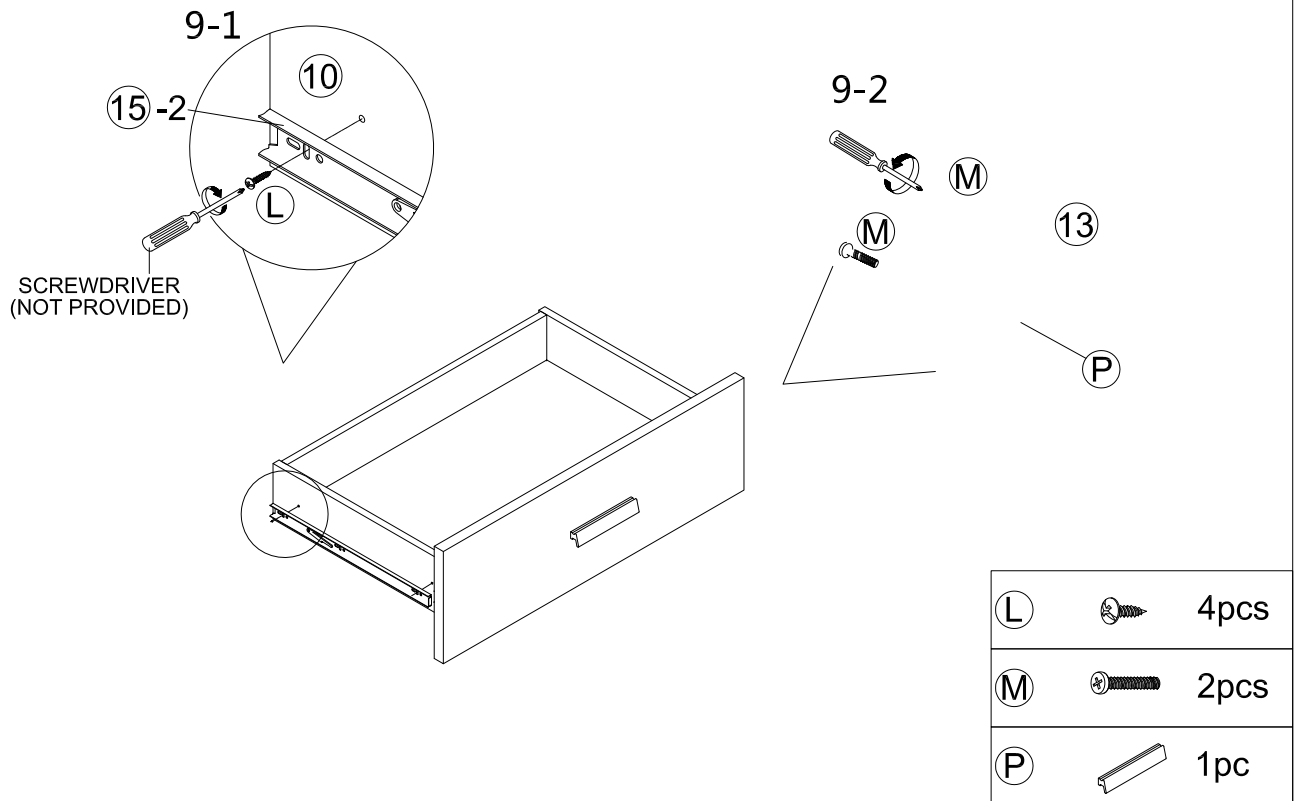

## STEP 10.

