

TV Stand

Assembly Instructions - Please keep for future reference



NOTE:

Comes with TWO PACKAGES with TWO TRACKINGS, may NOT be delivered at the same time.

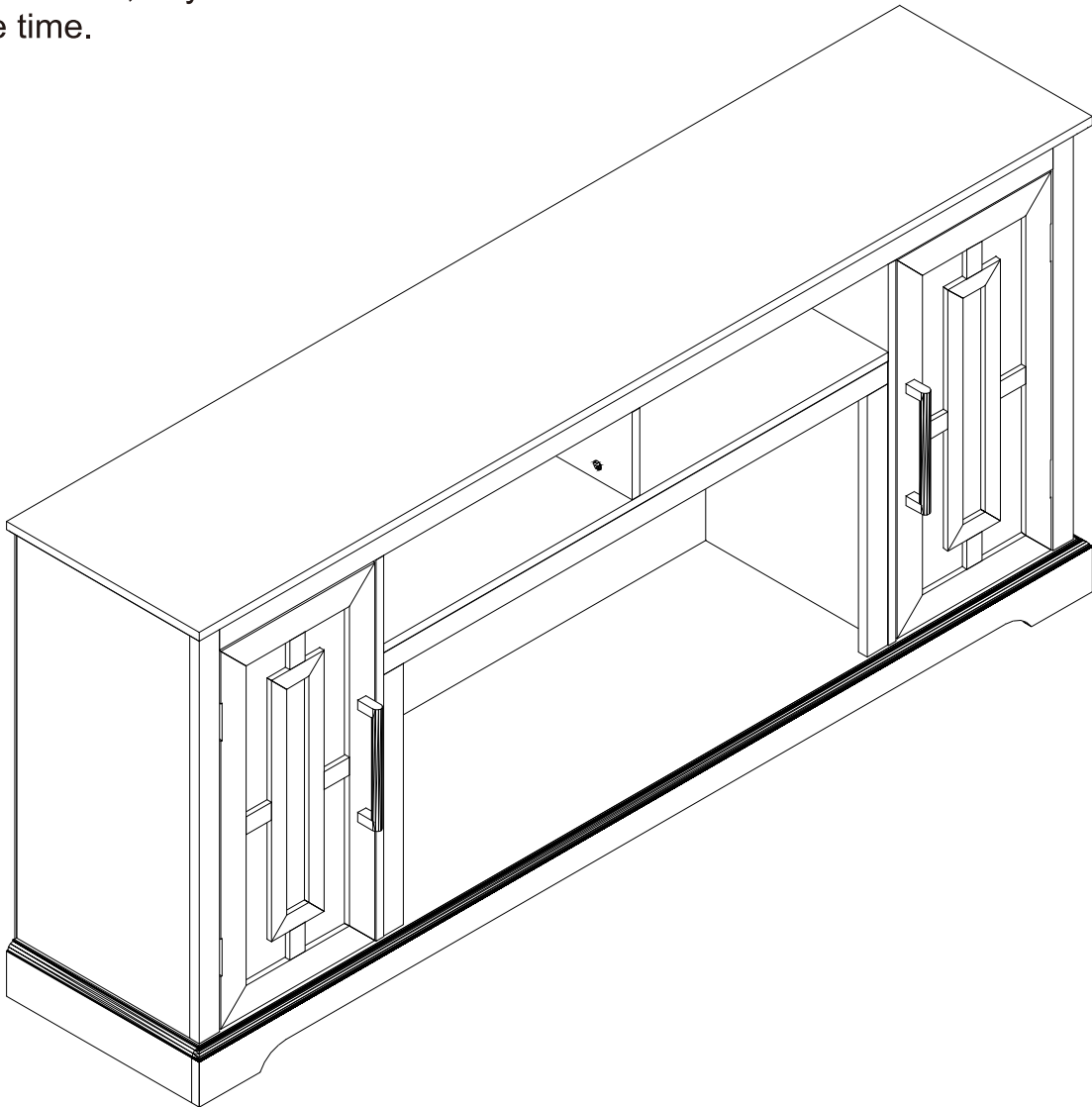

Dimensions

Width - 69.5inch

Depth - 15inch

Height - 32inch

Any question please feel free to contact us
We will provide further assistance within 24 hours.

Important – Please read these instructions fully before starting assembly



Safety and Care Advice

Important – Please read these instructions fully before starting assembly

- Check you have all the components and tools listed on the following pages.

- Remove all fittings from the plastic bags and separate them into their groups.

- Keep children and animals away from the work area, small parts could choke if swallowed.

- Make sure you have enough space to layout the parts before starting.

- During assembly do not stand or put weight on the product, this could cause damage.

- Assemble the item as close to its final position (in the same room) as possible.

- Assemble on a soft level surface to avoid damaging the unit or your floor.

- Parts of the assembly will be easier with 2 people.

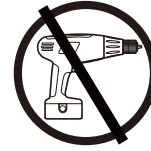

power drill is set on a low torque setting.

- To reduce the likelihood of damaging your product please ensure that your

Care and maintenance

- Only clean using a damp cloth and mild detergent, do not use bleach or abrasive cleaners.

- From time to time check that there are no loose screws on this unit.

- This product should not be discarded with household waste. Take to your local authority waste disposal centre.

Handy Hints

- Assemble all parts and bolts loosely during assembly, only once the product is complete should you fully tighten the bolts

- Regularly check and ensure that all bolts and fittings are tightened properly.

WARNING

In order to help prevent overturning please follow these instructions

To help prevent product toppling over please follow the steps below:

- Must use the anti tip strap or wall fixing method provided (whichever applies).
- Do not allow children to climb or hang on the furniture.
- Do not place heavy items on top of the furniture, unless the furniture has been designed for this purpose
- Installation shall be carried out exactly according to the instructions- otherwise a safety risk can occur
- In order to prevent falling down this product must be used with the wall attachment device provided.

Please note that only the wall attachment device is provided. You will need to supply wall plugs and screws applicable for your wall type.

Components - Panels

Please check you have all the fittings listed below

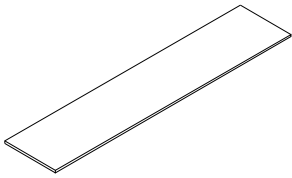

1 (176.5*38*3cm)x1

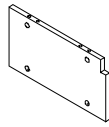

2 (36.1*19.1*1.5cm)x1

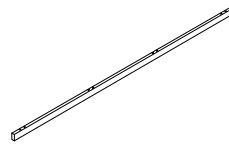

3 (164.7*4*1.8cm)x1

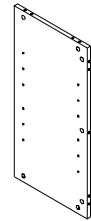

4 (69.3*34.3*1.5cm)x2



5 (69.3*4*1.8cm)x1



6 (69.3*4*1.8cm)x1



7 (69.3*36.1*1.5cm)x1

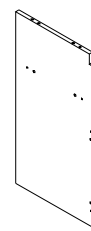

8 (69.3*36.1*1.5cm)x1

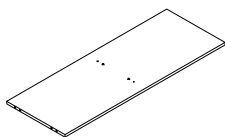

9 (99.7*36.1*1.5cm)x1

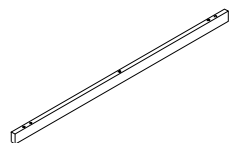

10 (99.7*4*1.8cm)x1



11 (44.7*4*1.8cm)x1



12 (44.7*4*1.8cm)x1

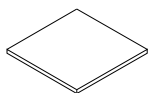

13 (32.8*32.8*1.5cm)x4

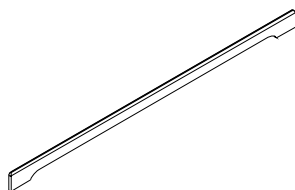

14 (176.7*9*1.5cm)x1

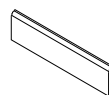

15 (36.5*9*1.5cm)x1

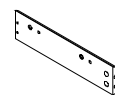

16 (36.5*9*1.5cm)x1

Components - Panels

Please check you have all the fittings listed below

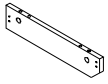

17 (35*7.5*1.5cm)x2

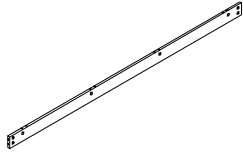

18 (173.5*7.5*1.5cm)x1

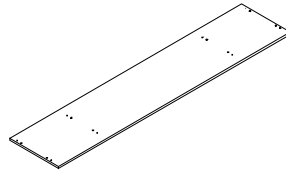

19 (173.5*36.5*1.5cm)x1

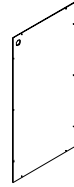

20 (72.1*36.2*0.27cm)x2

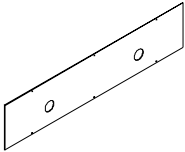

21 (100.1*21.9*0.27cm)x1

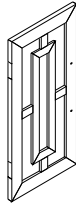

22 (64.7*30.4*1.8cm)x1

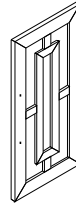

23 (64.7*30.4*1.8cm)x1

Components - Fittings

Please check you have all the fittings listed below

Note: The quantities below are the correct amount to complete the assembly. In some cases more fittings may be supplied than are required.



Cam Bolt x 57+4



Cam Lock x 57+4

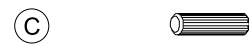

Wooden Dowel x 46+4



Screw x 48+2



Triple Fold Hinge x 4



Handle x 2



Screw x 4

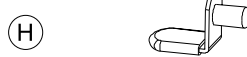

Shelf Pin x 16



Screw x 30+2



Screw x 12



Plastic Connector x 8



Screw x 16+1



Plastic Connector x 4



Beauty patch x 32



x2



x2



Iron sheet x 4



Magnetic attraction x 2

Assembly Instructions

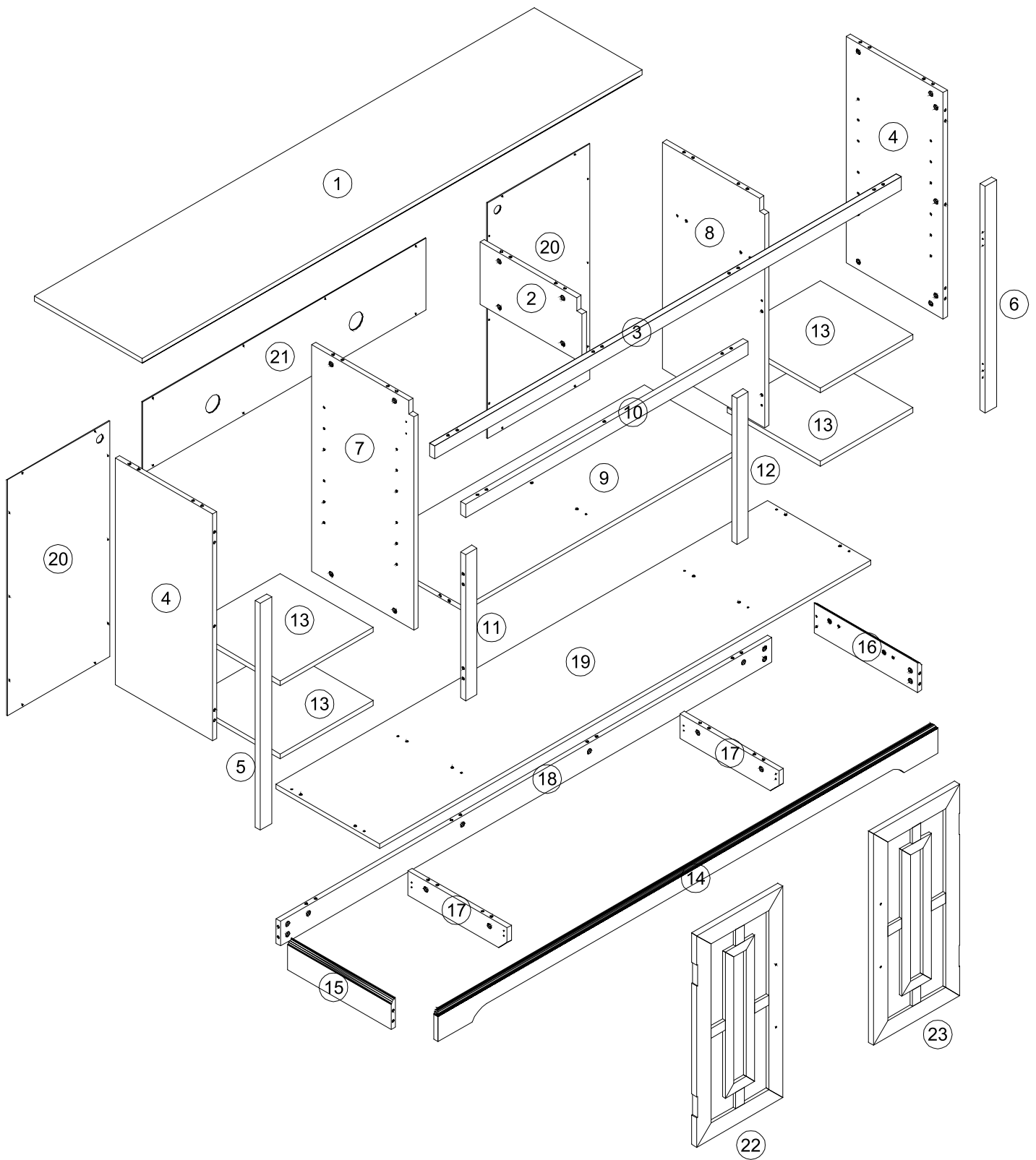

Using Camlocks

Step 1

Connect the male camlock as directed in the assembly instructions using a screwdriver.

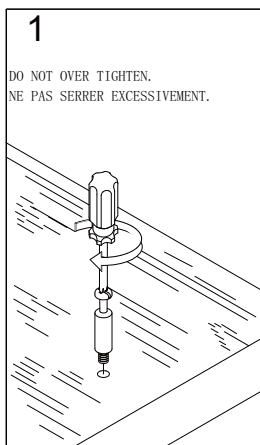

Step 2

Push the male camlock into the entry hole.

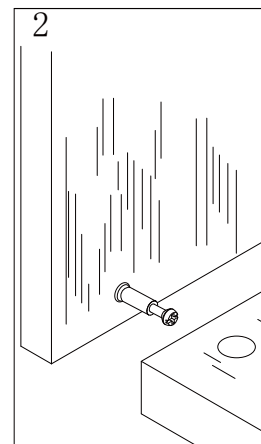

Step 3

Insert the female camlock as shown in the instructions.
Note: ensure that the arrow on the top of the camlock points towards the entry hole for the male camlock.

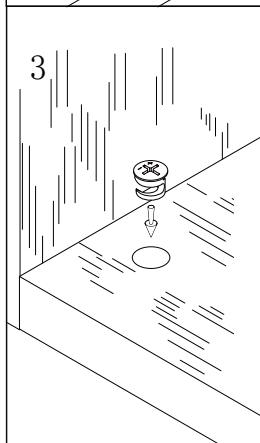

Step 4

Turn the female camlock clockwise with a screw driver.
You should feel a click when the camlock is locked in place.
The joint is now secure.

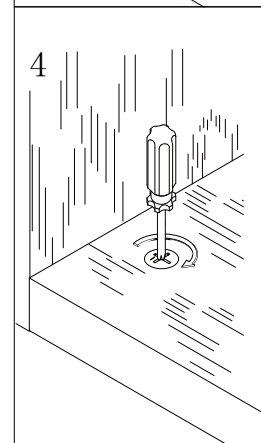

Assembly Instructions

Step 1

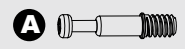
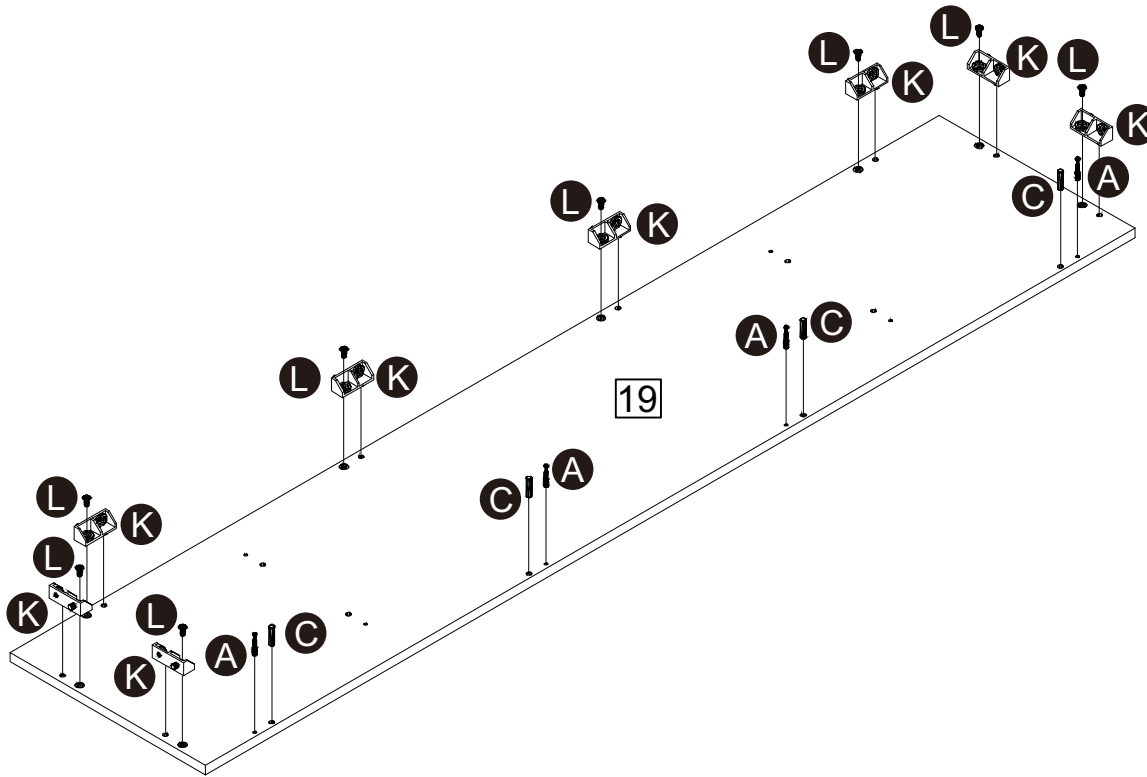

A x 4



C x 4



K x 8



L x 8

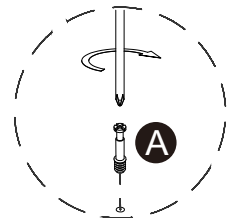

Step 2

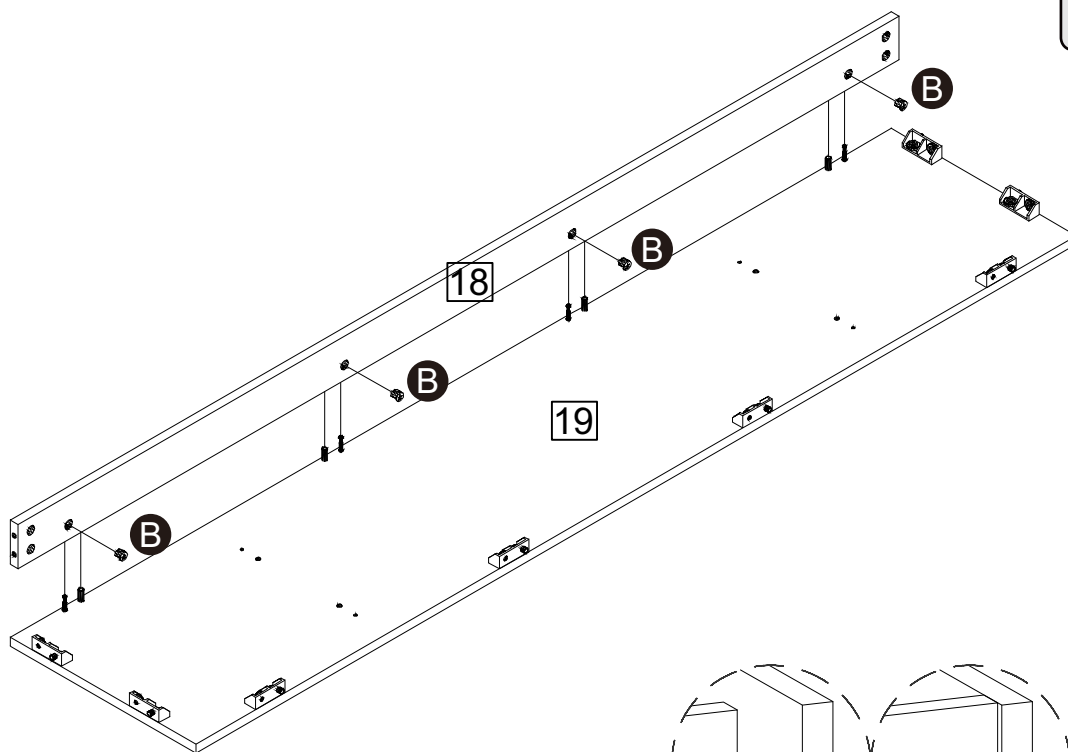

B x 4

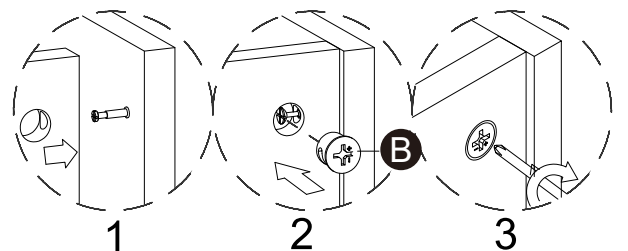

Assembly Instructions

Step 3

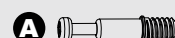
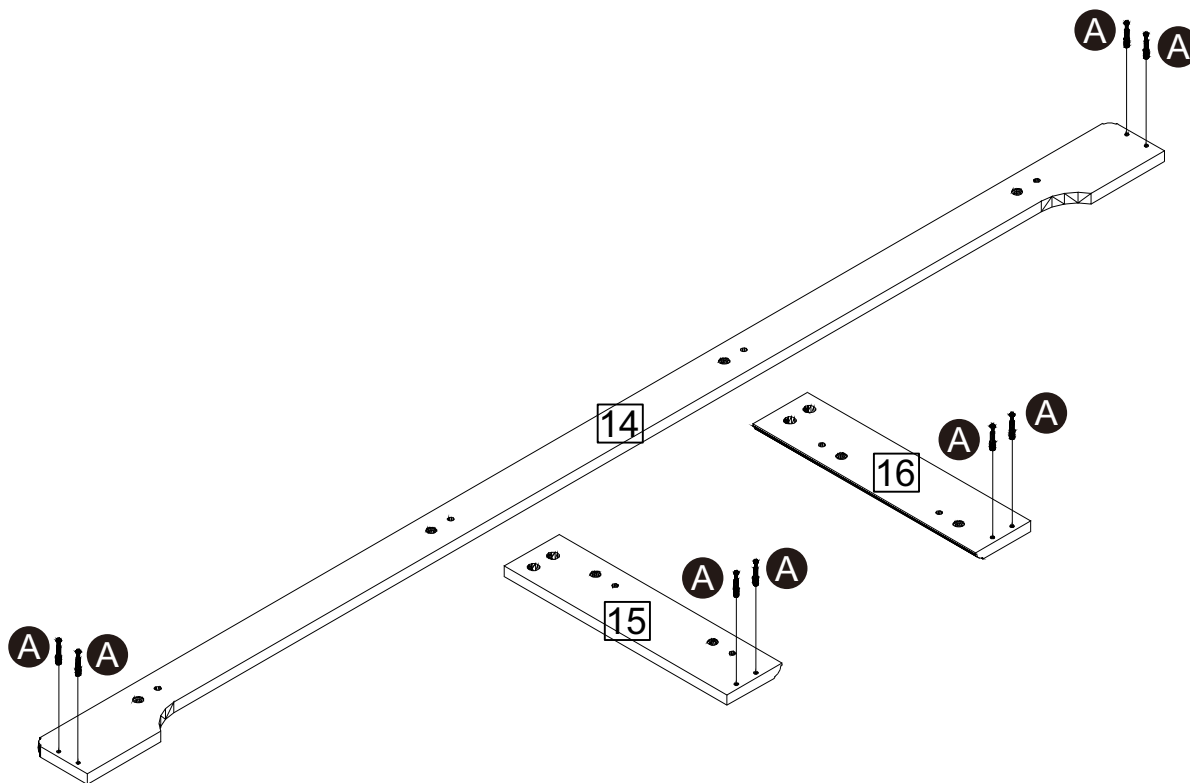

A x 8

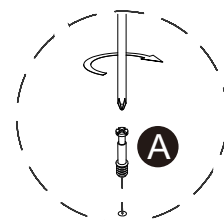

Step 4

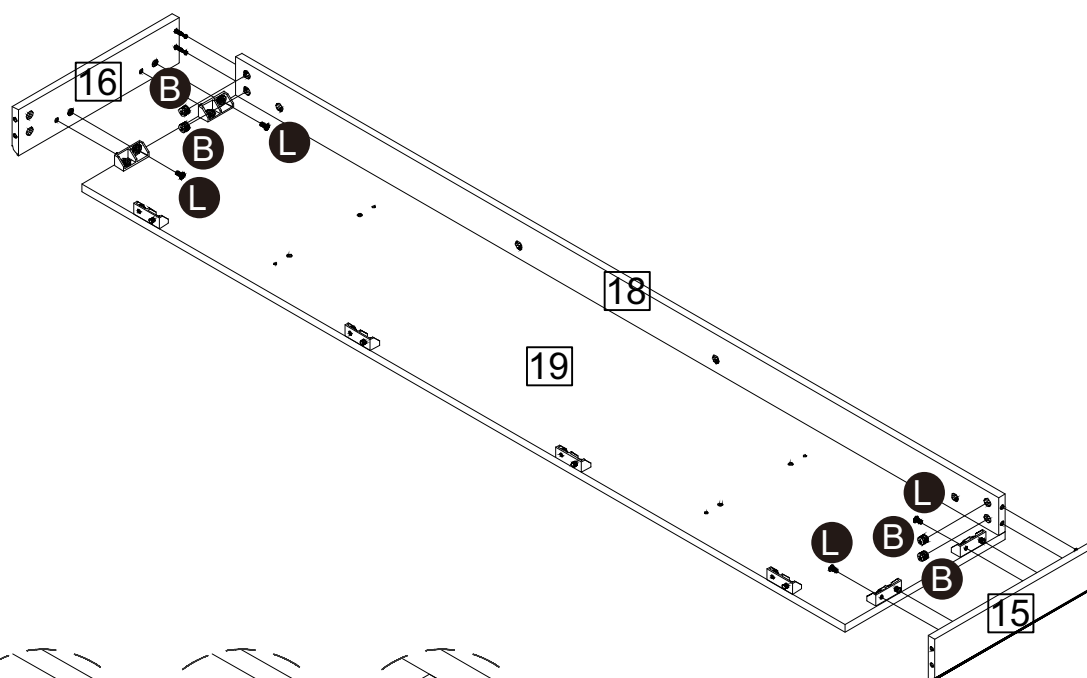

B x 4



L x 4

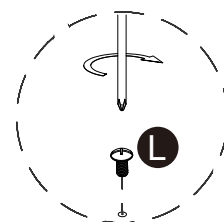
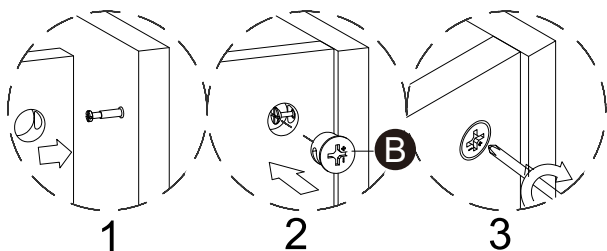

Assembly Instructions

Step 5

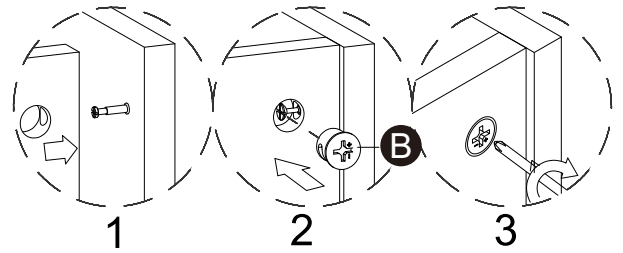
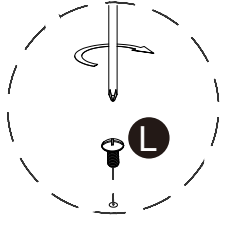
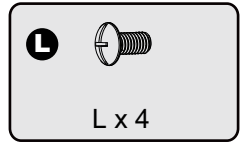
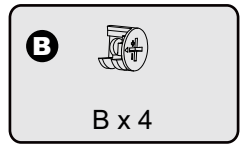
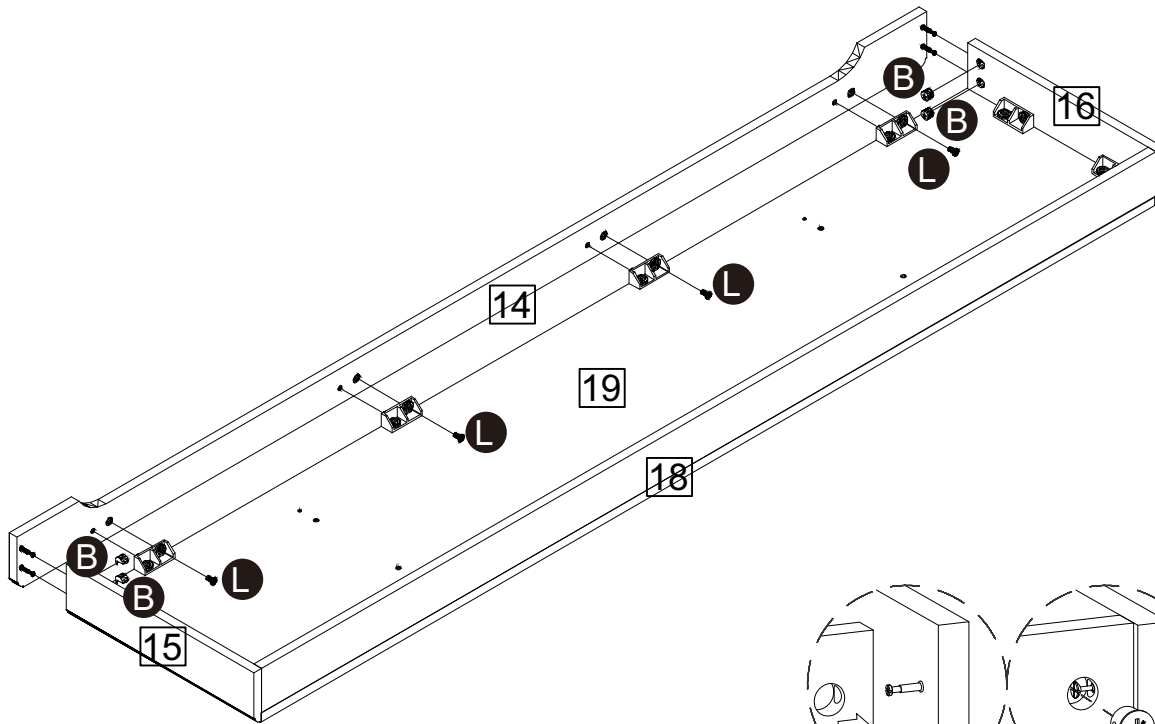

Step 6

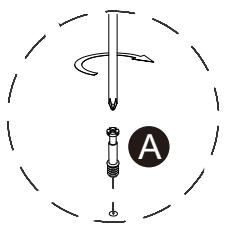
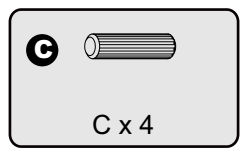
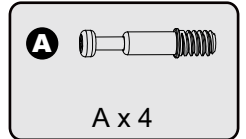
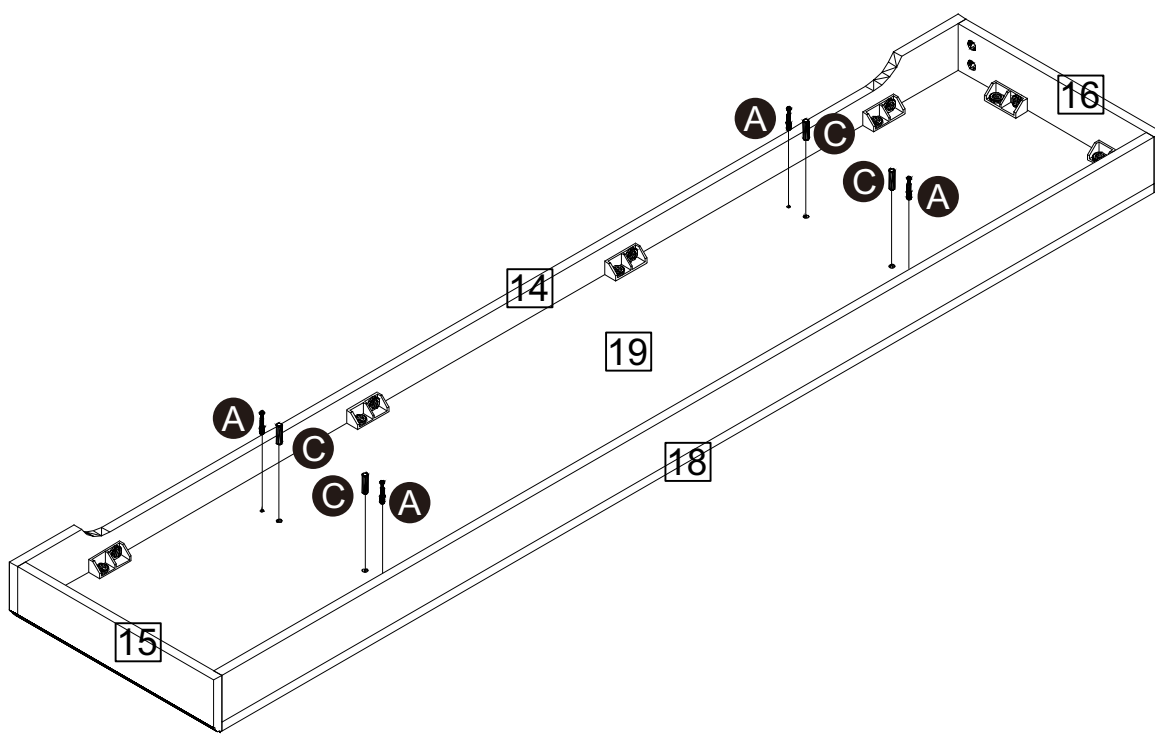

Assembly Instructions

Step 7



B x 4

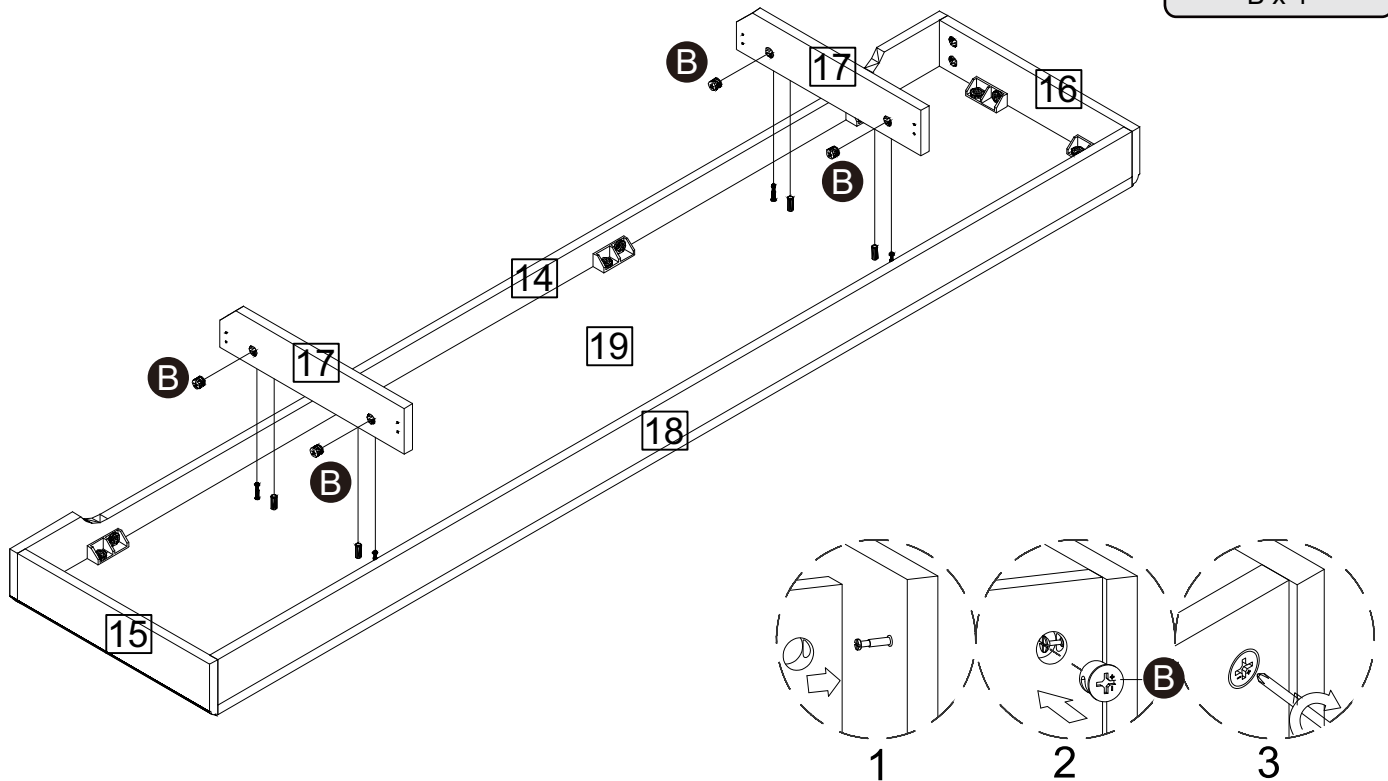

Step 8



M x 4



D x 16

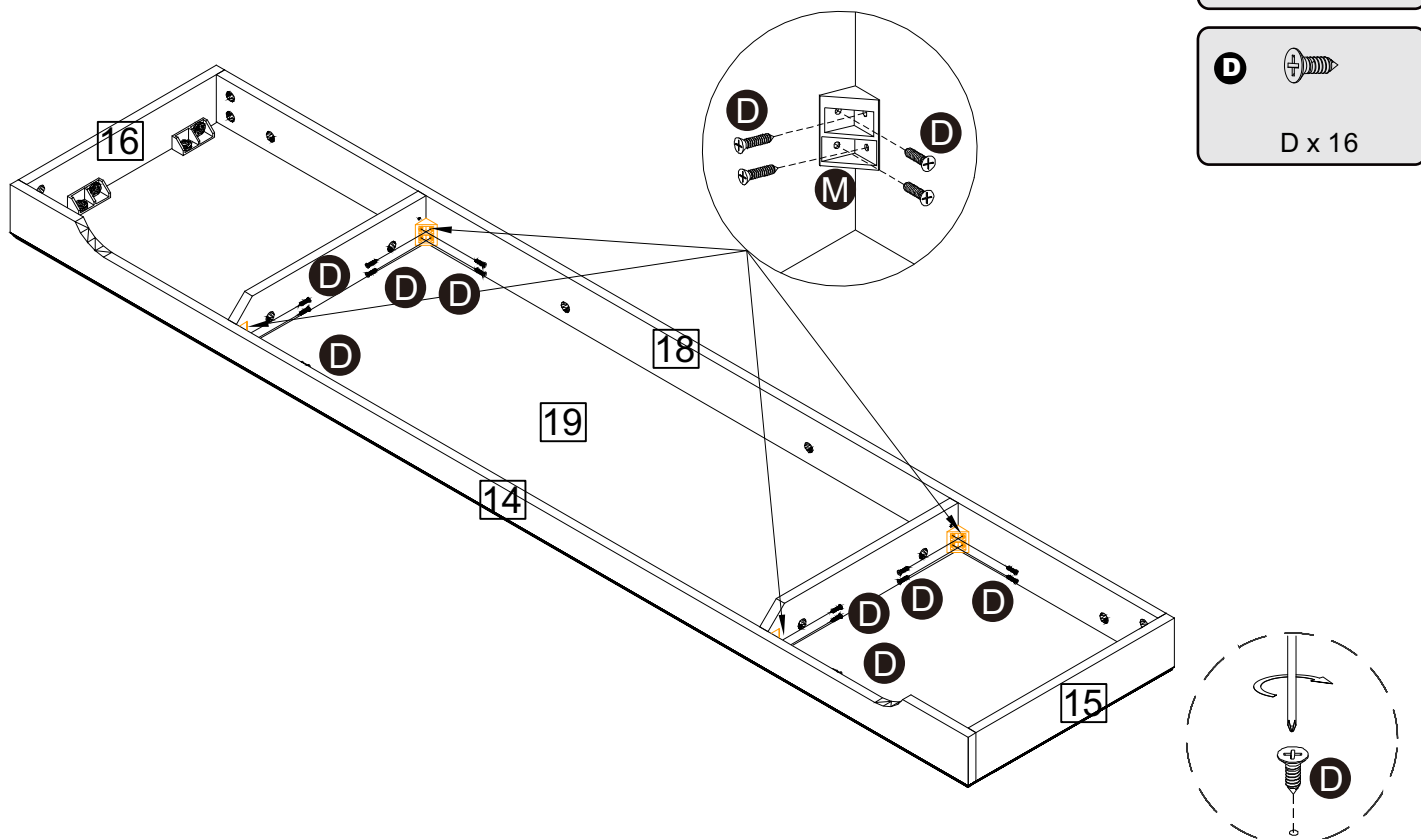

Assembly Instructions

Step 9

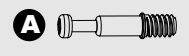
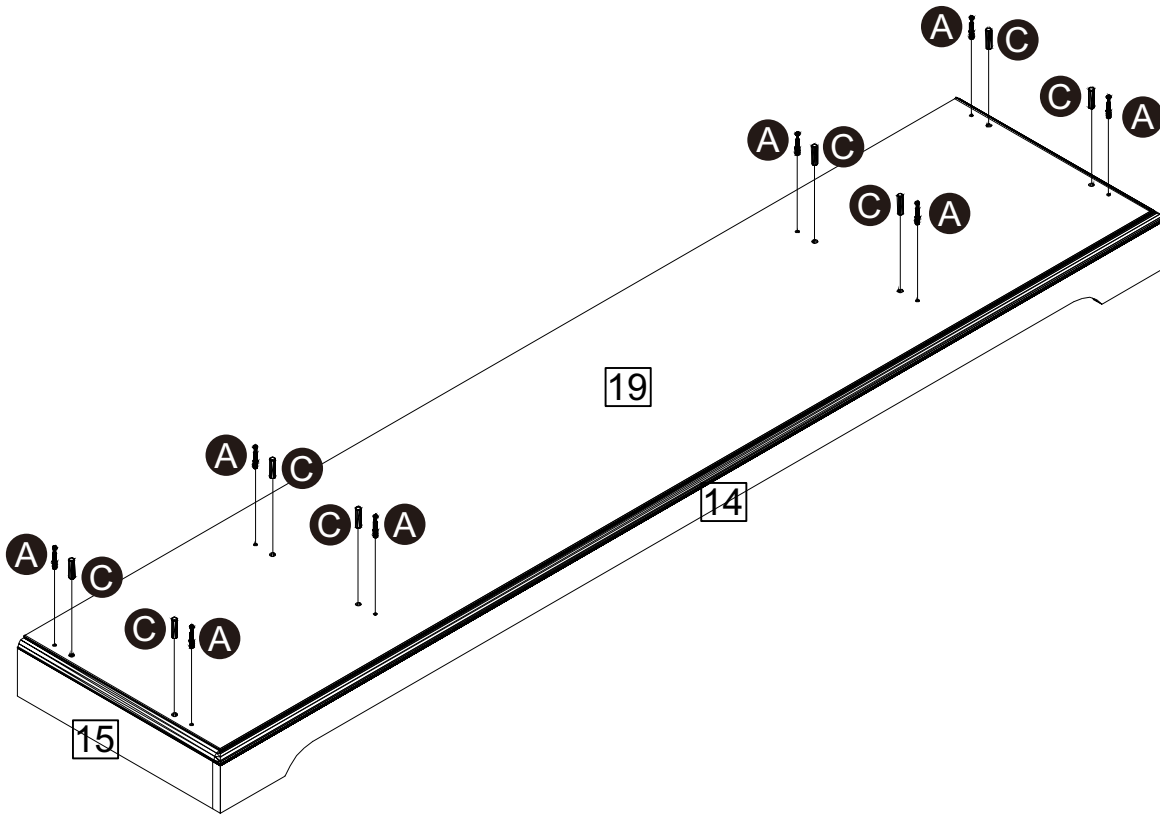

A x 8

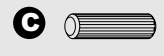

C x 8

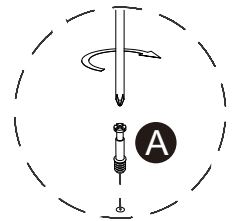

Step 10

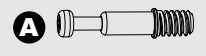
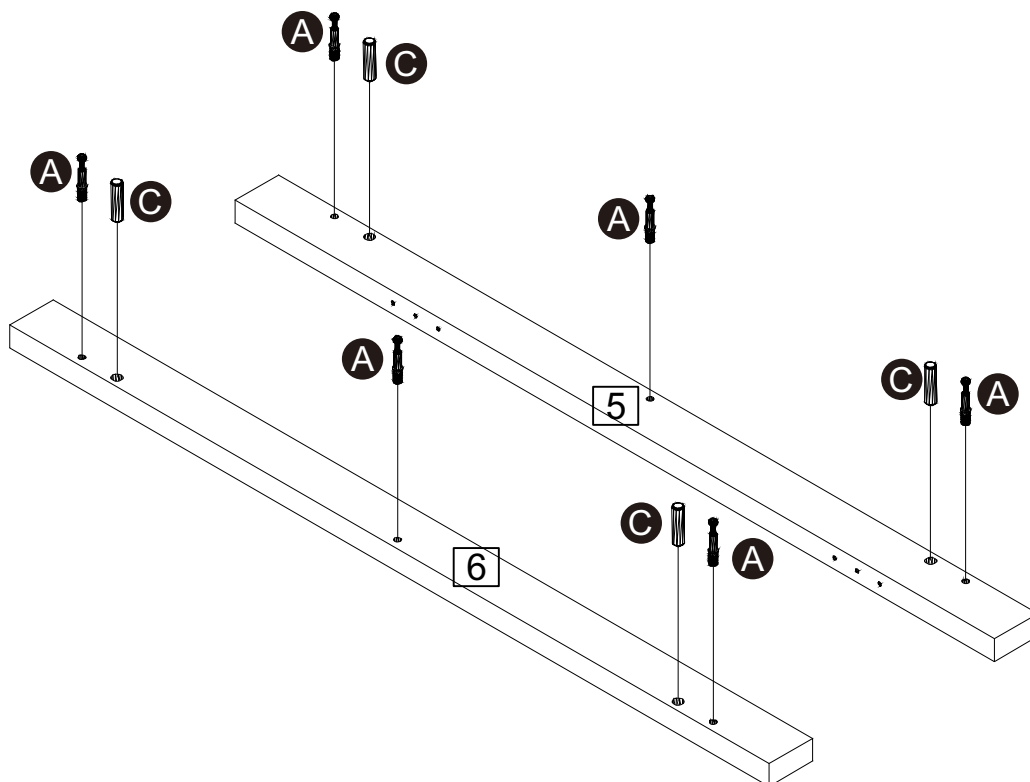

A x 6

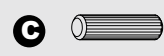

C x 4

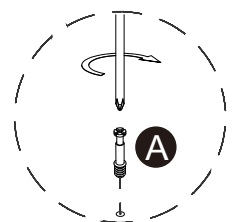

Assembly Instructions

Step 11

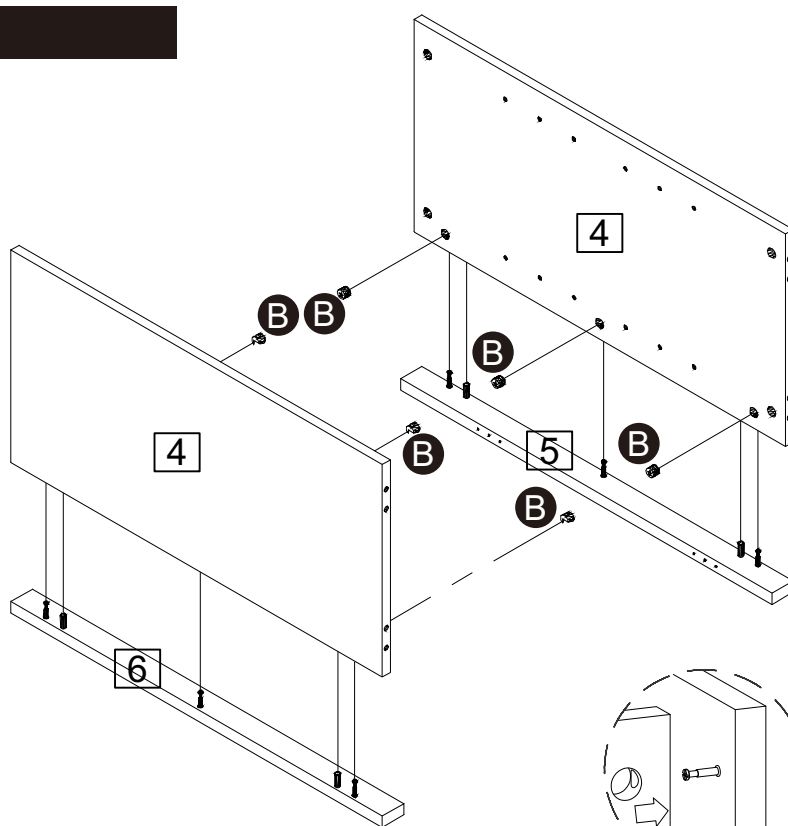

B x 6

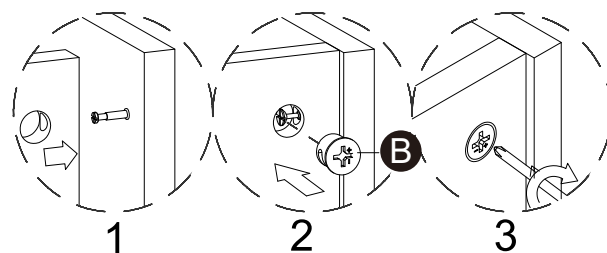

Step 12

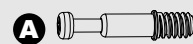
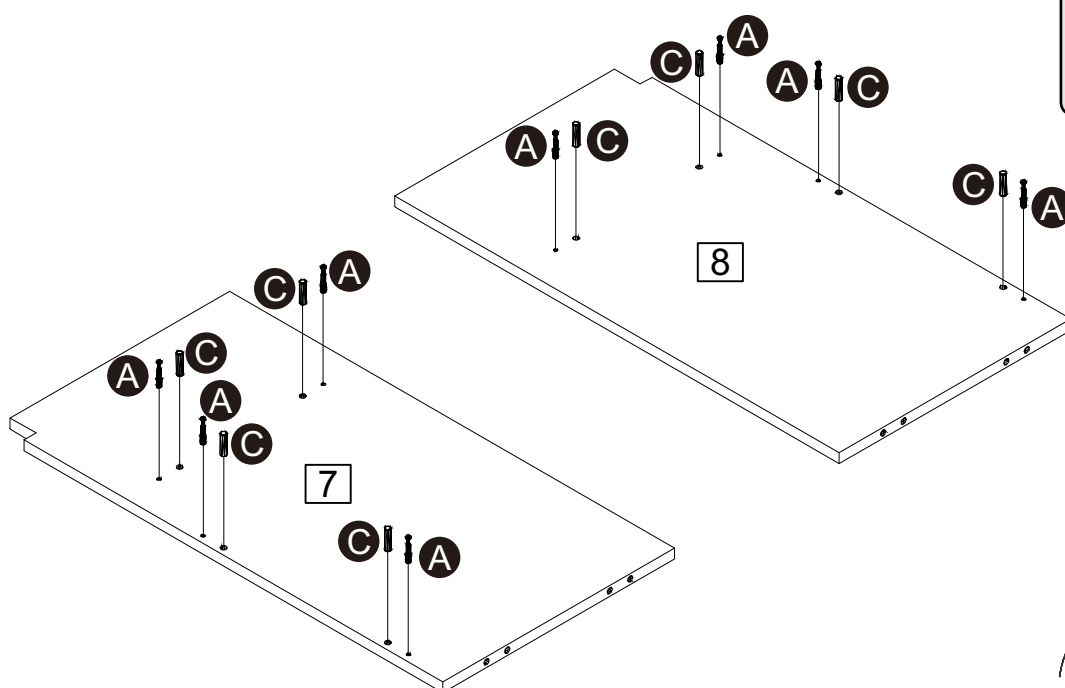

A x 8



C x 8

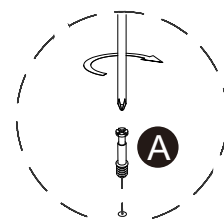

Assembly Instructions

Step 13

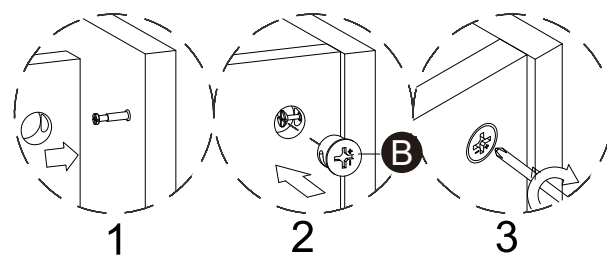
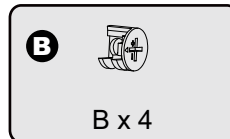
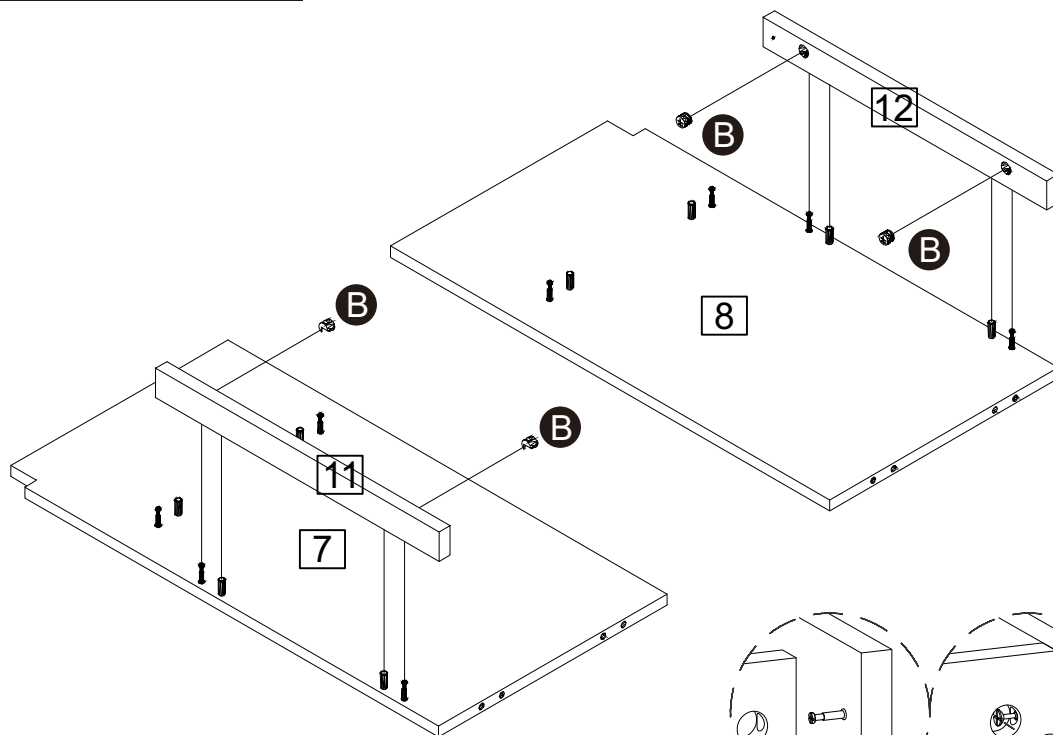

Step 14

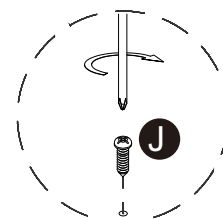
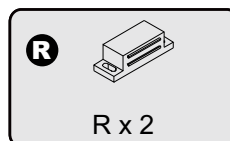
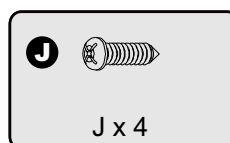
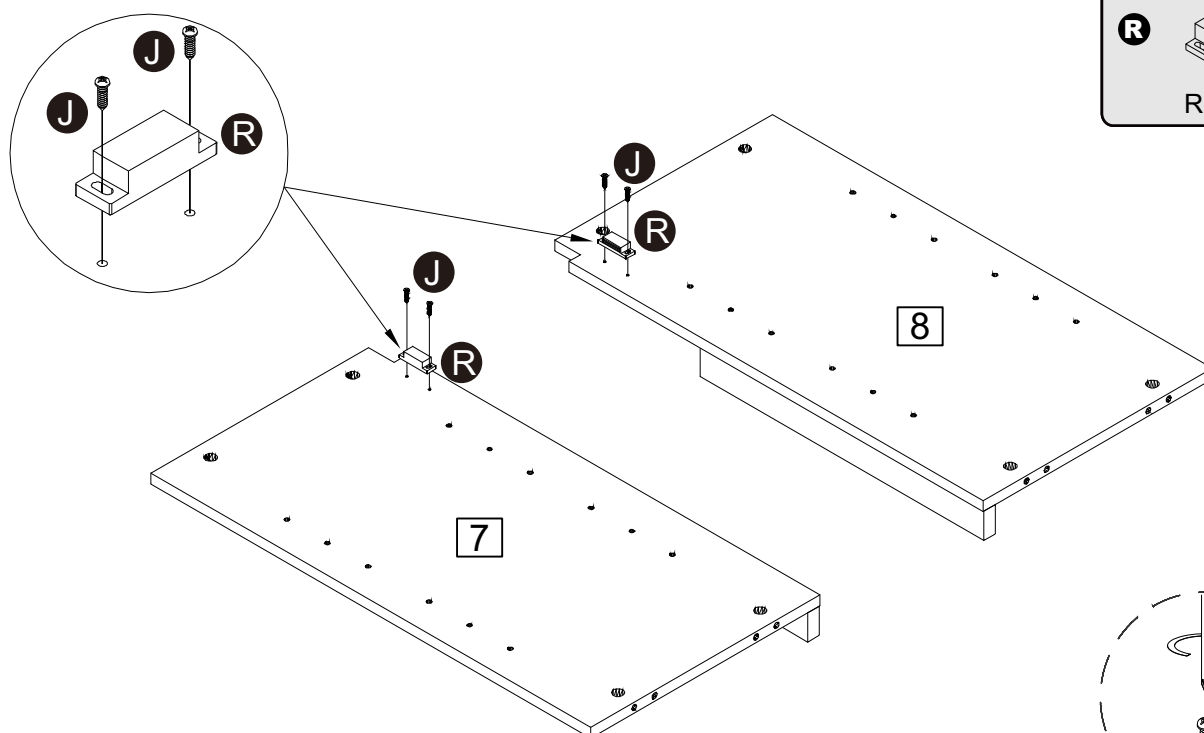

Assembly Instructions

Step 15

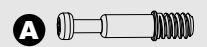
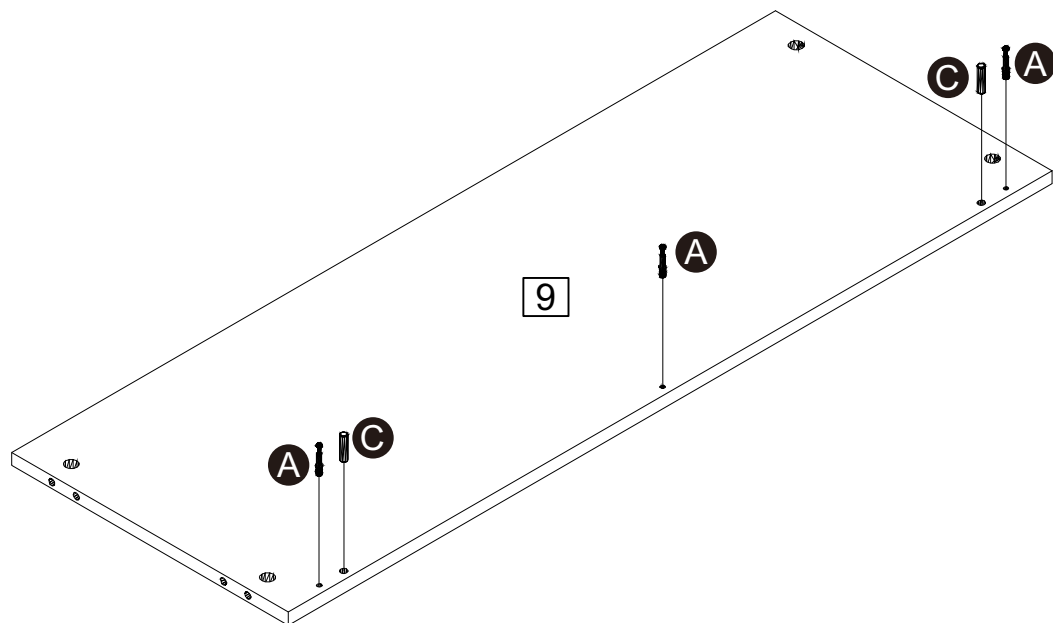

A x 3



C x 2

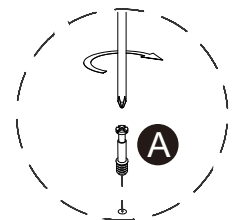

Step 16

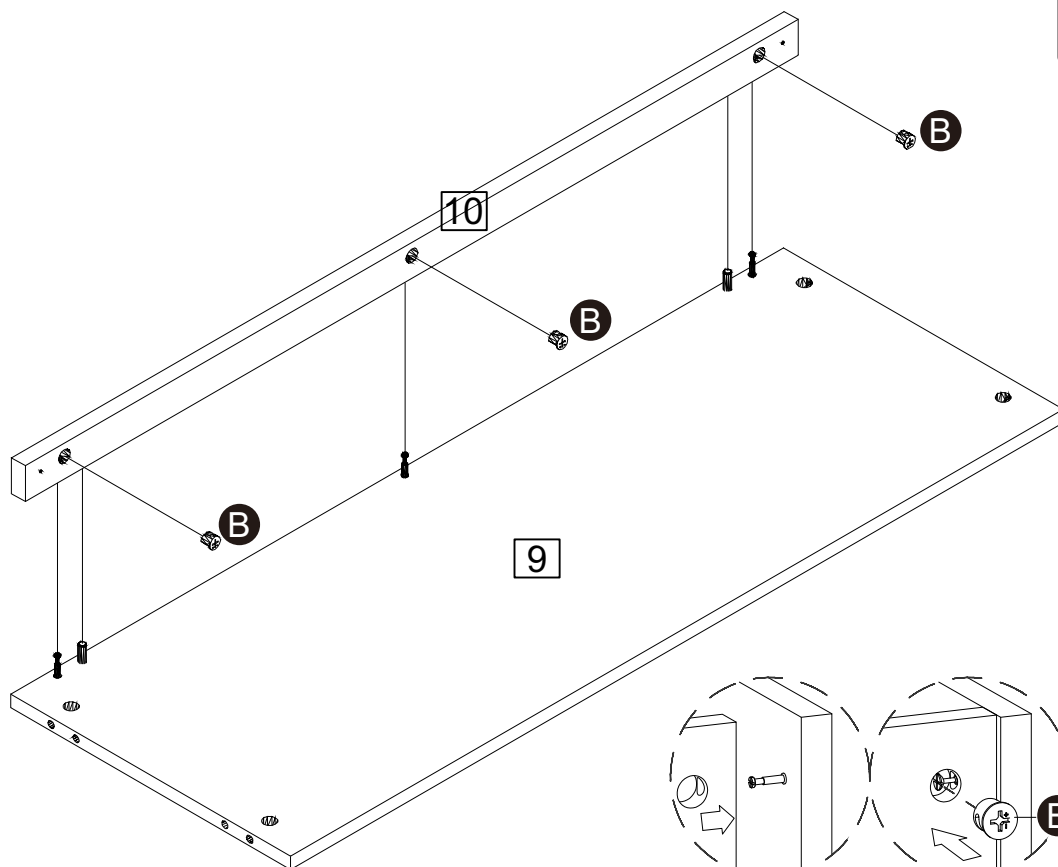

B x 3

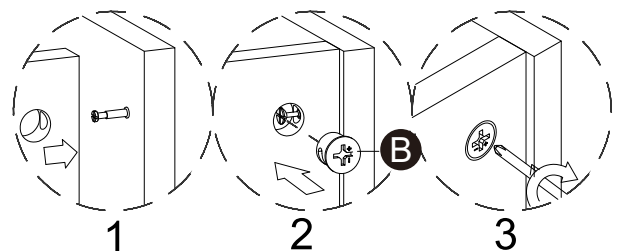

Assembly Instructions

Step 17

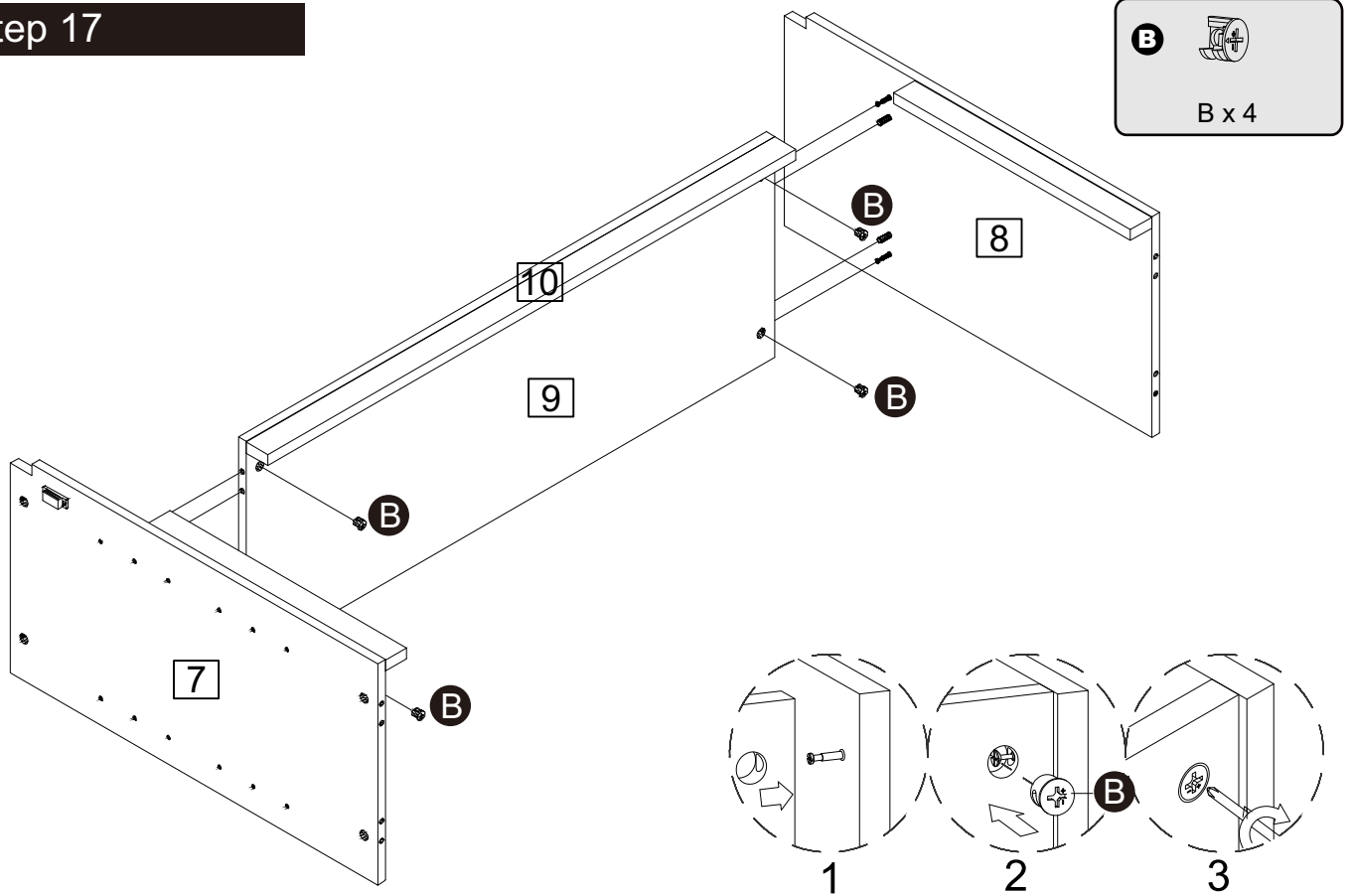

Step 18

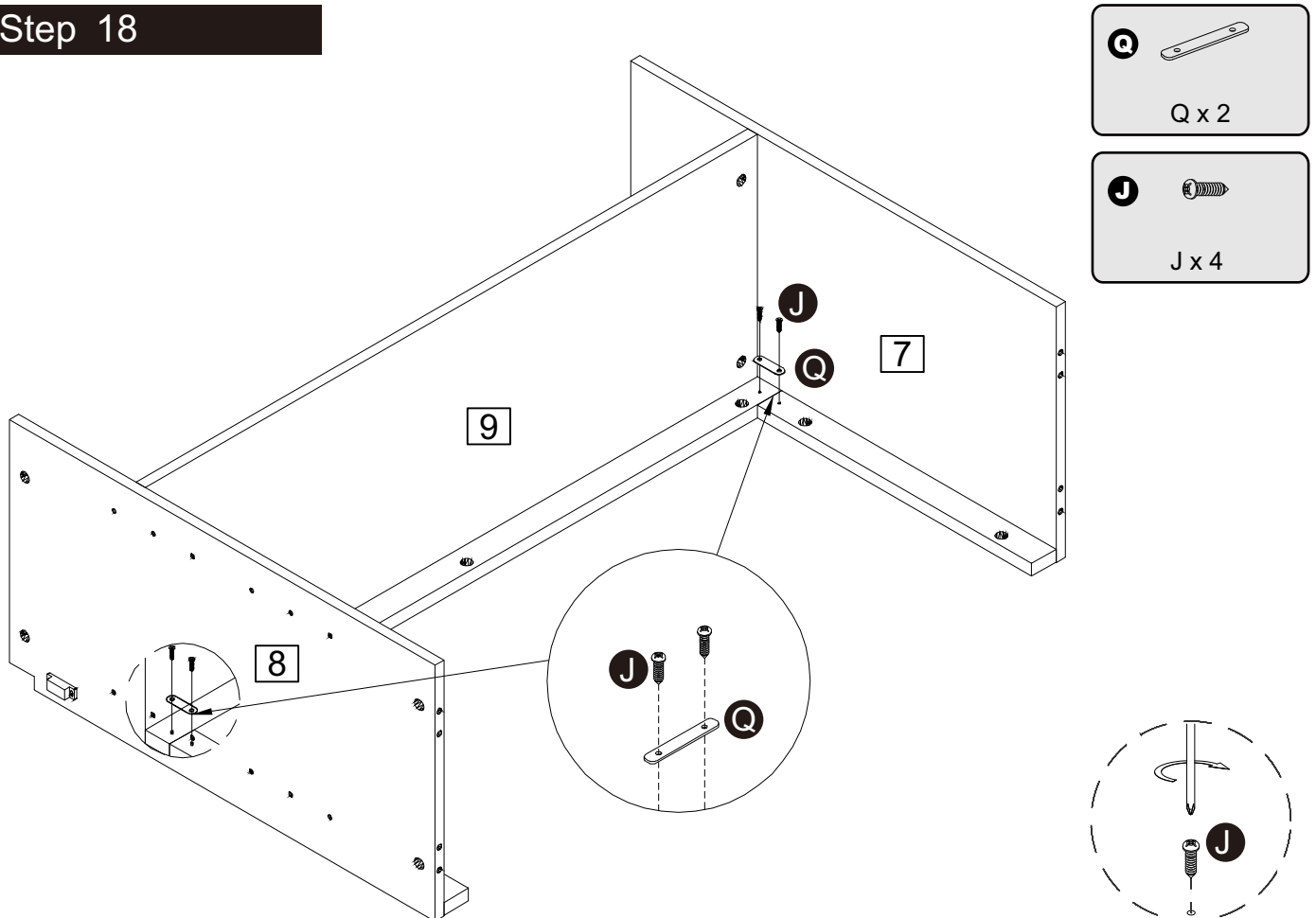

Assembly Instructions

Step 19

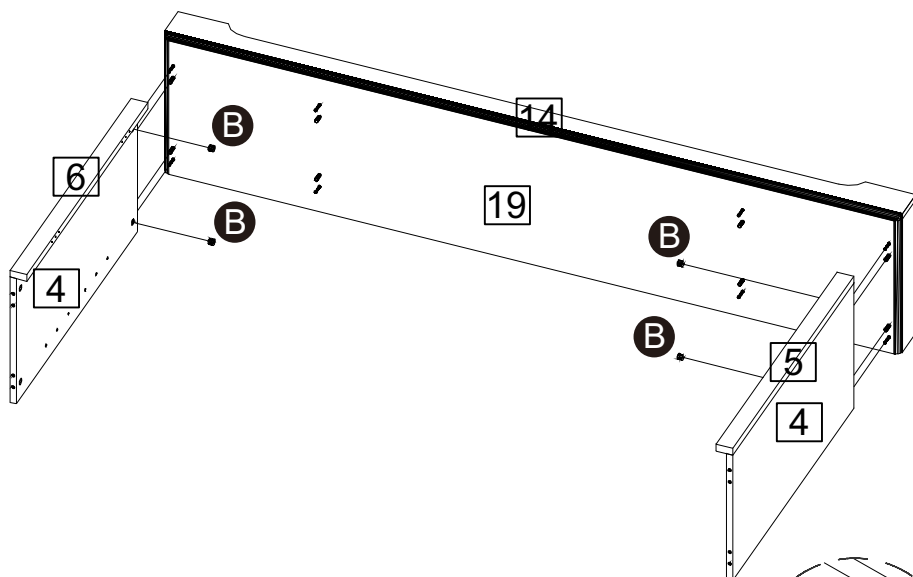

B x 4

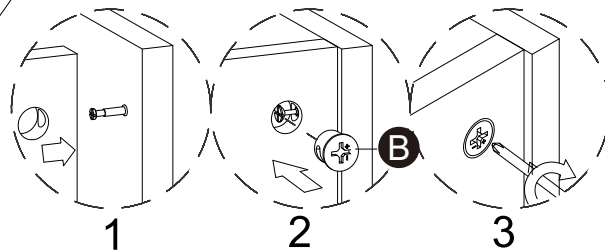

Step 20

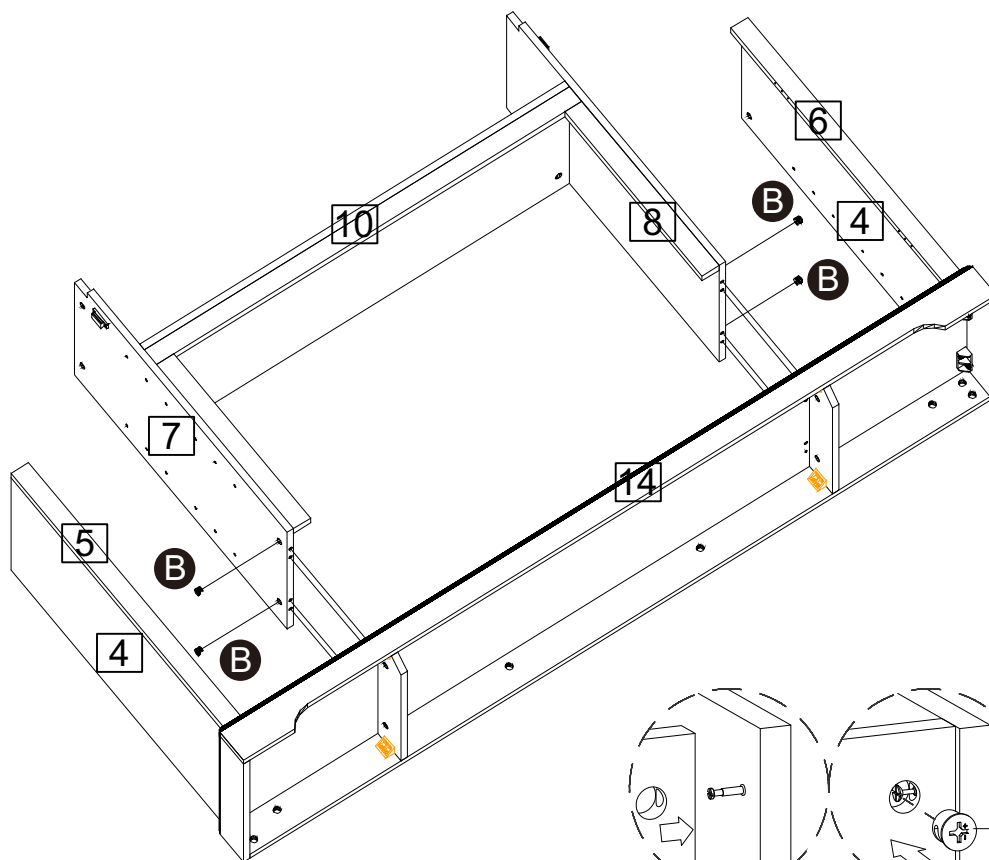

B x 4

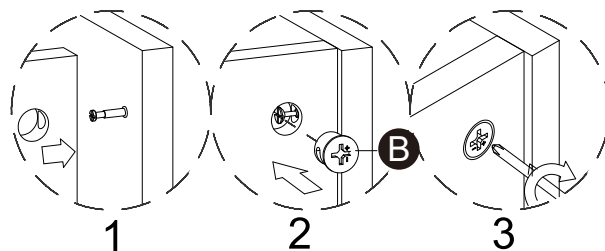

Assembly Instructions

Step 21

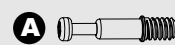
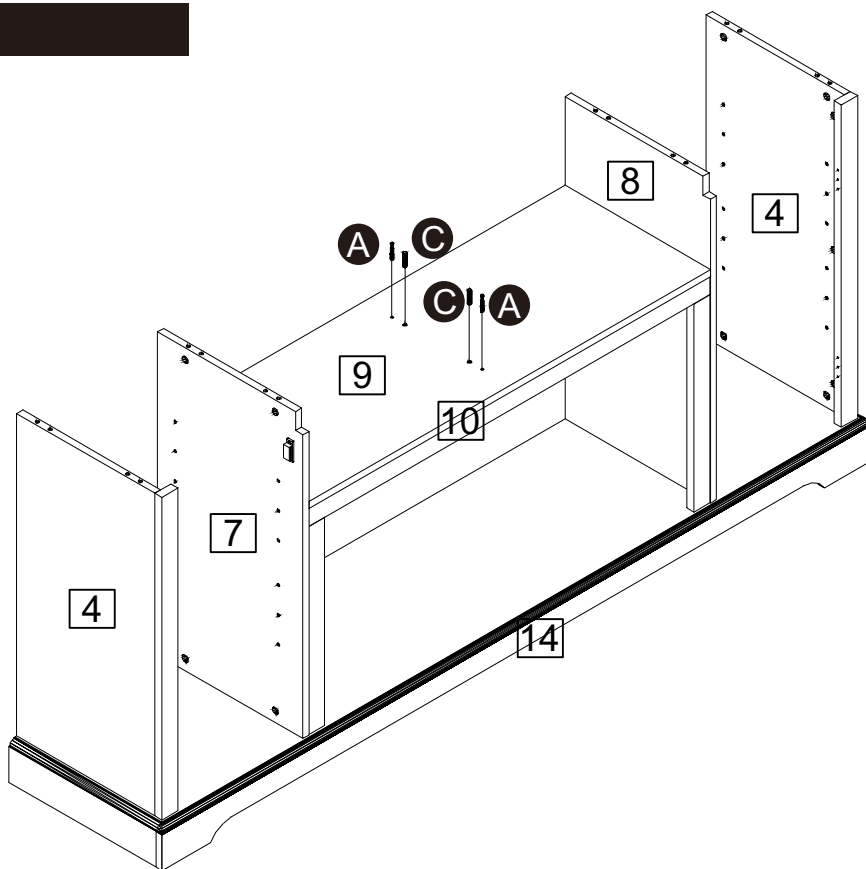

A x 2



C x 2

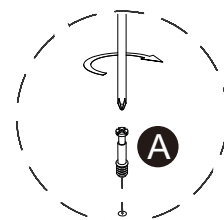

Step 22

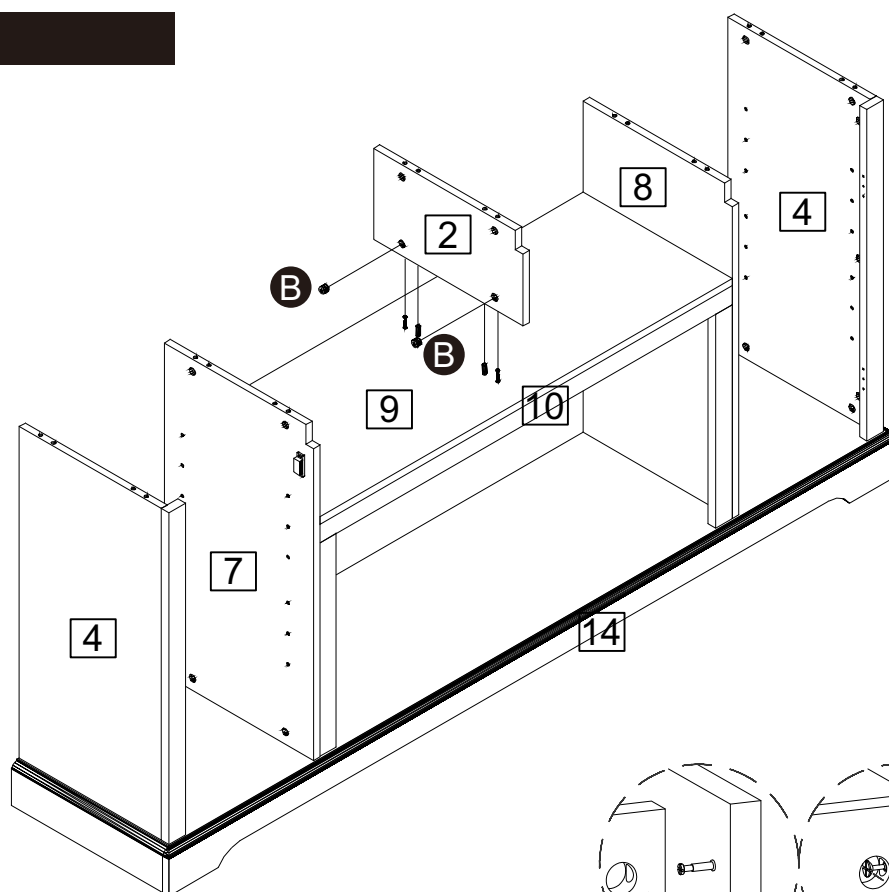

B x 2

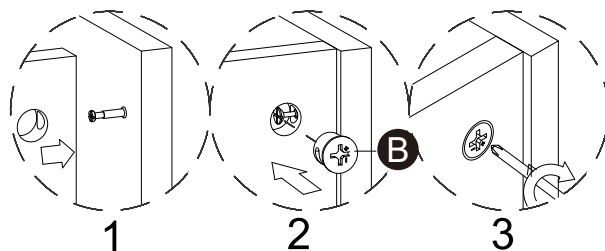

Assembly Instructions

Step 23

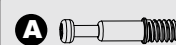
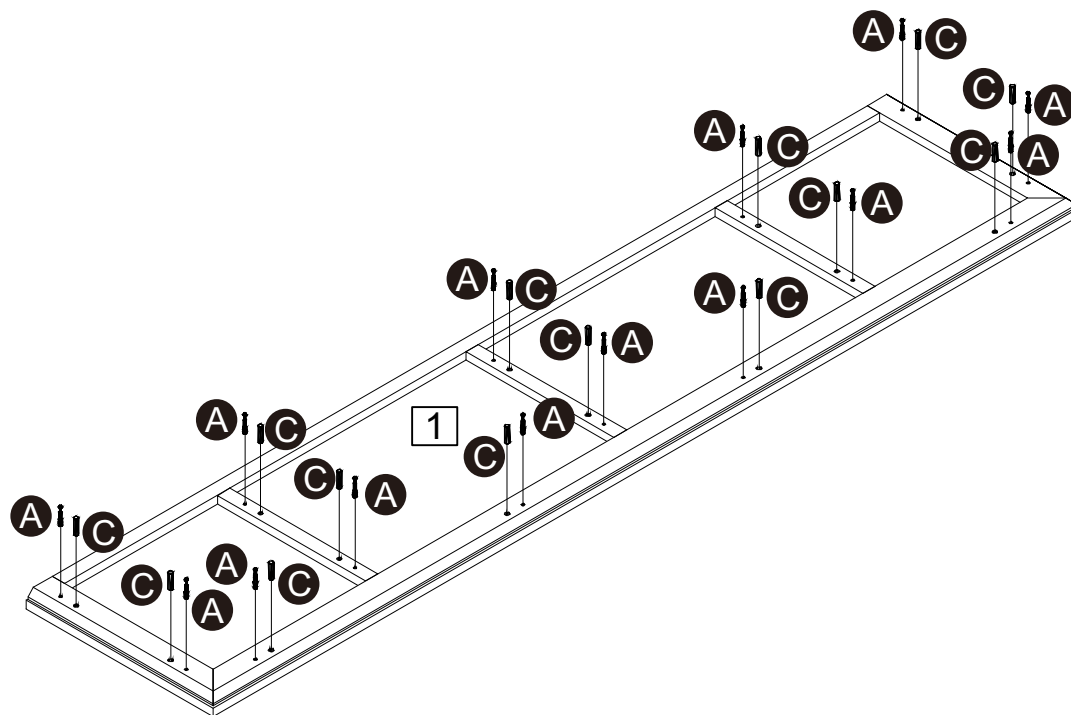

A x 14



C x 14

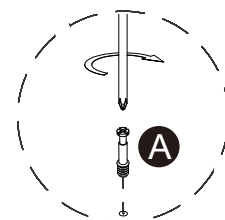

Step 24

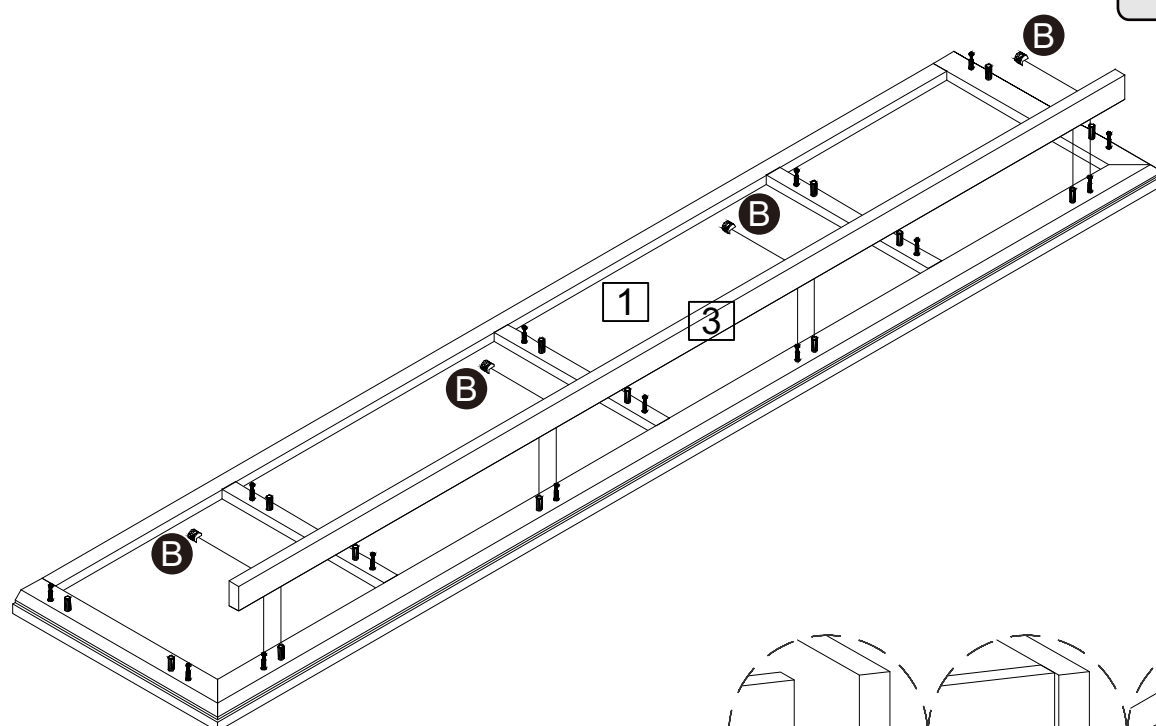

B x 4

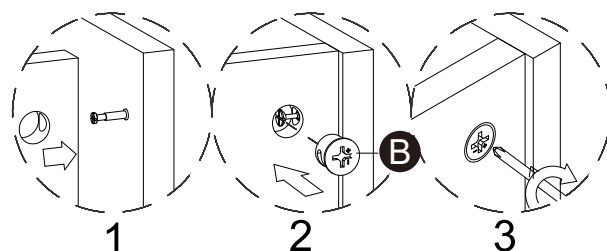

Assembly Instructions

Step 25

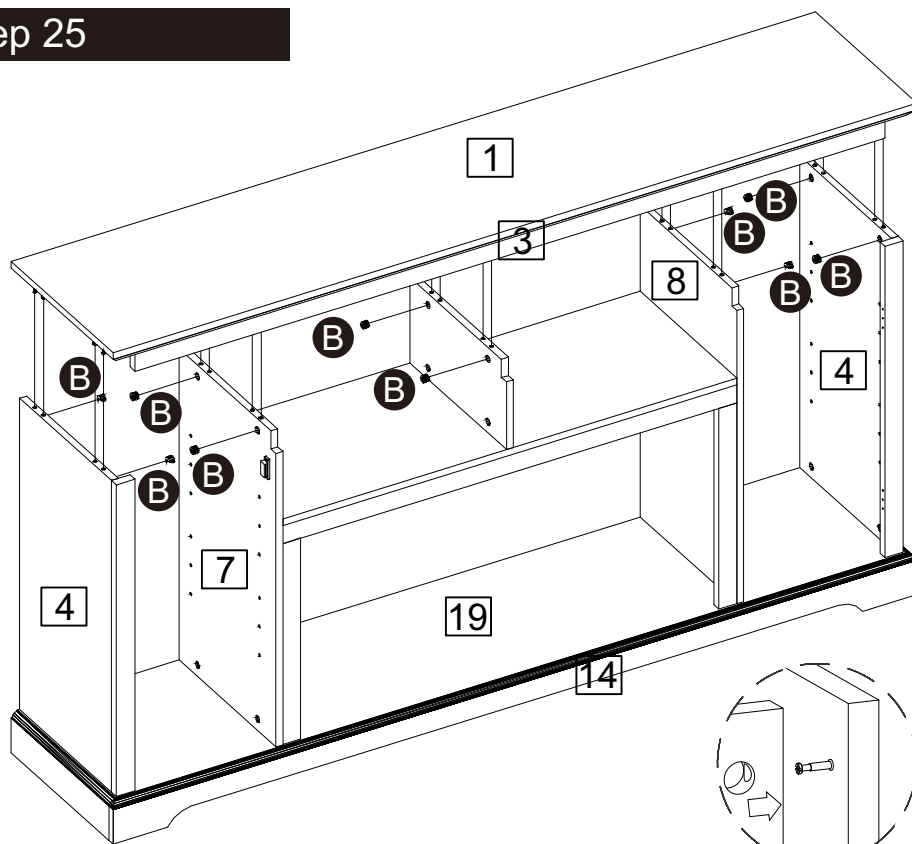

B x 10

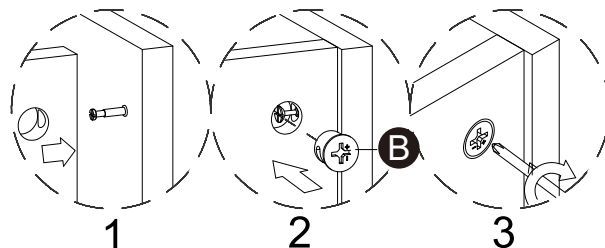

Step 26

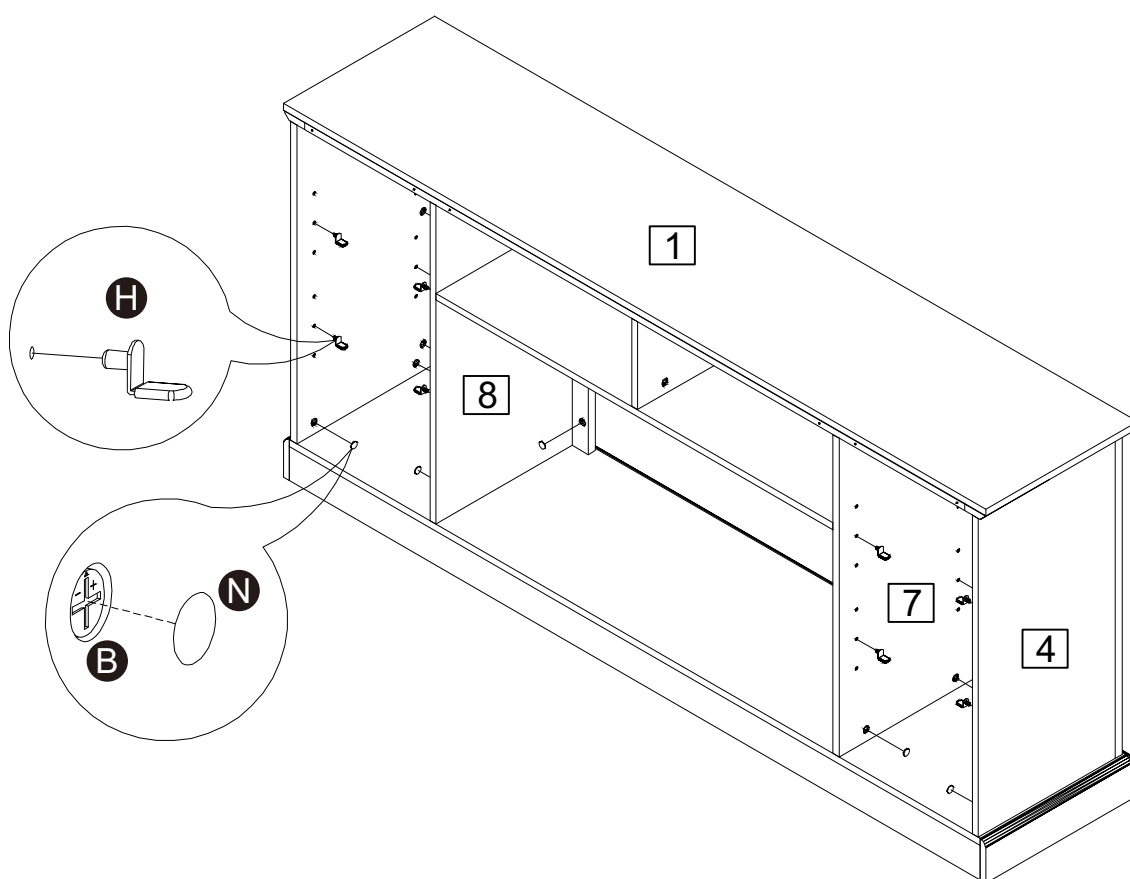

H x 16



N x 32

Assembly Instructions

Step 27

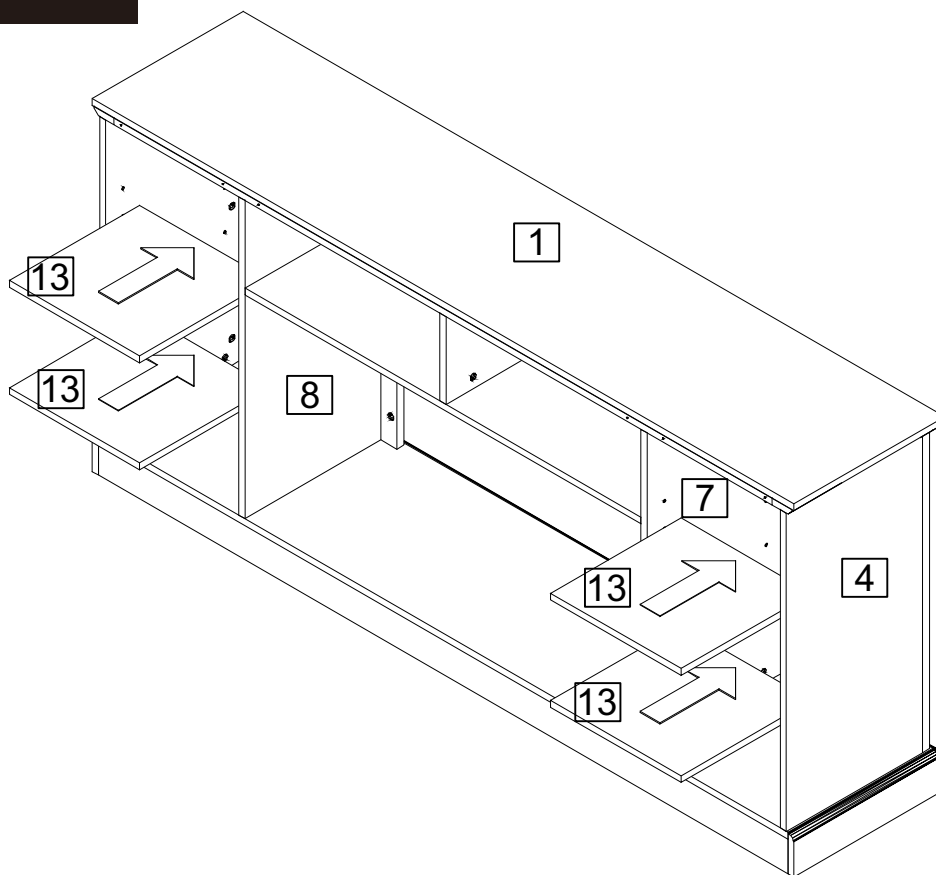

Step 28

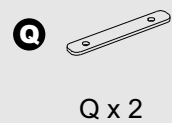
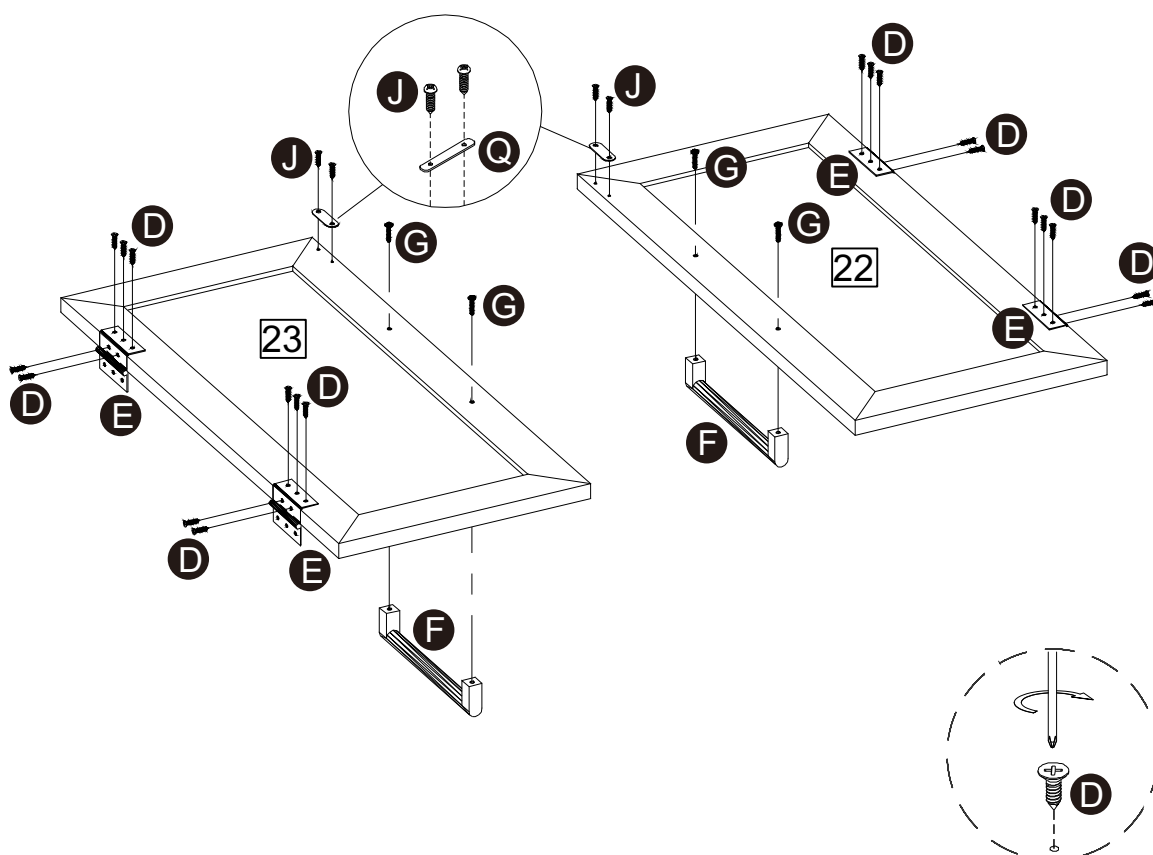

Assembly Instructions

Step 29

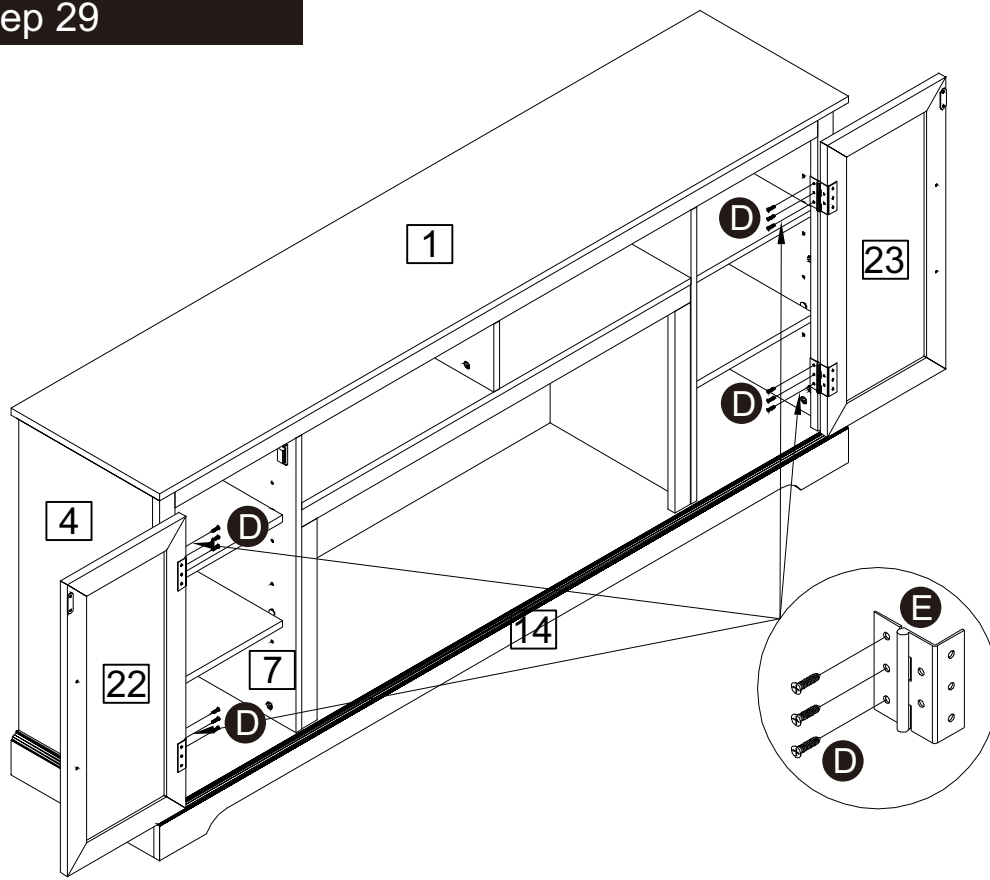

D 
D x 12

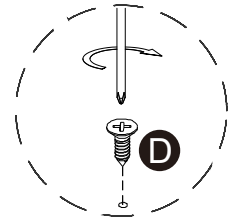

Step 30

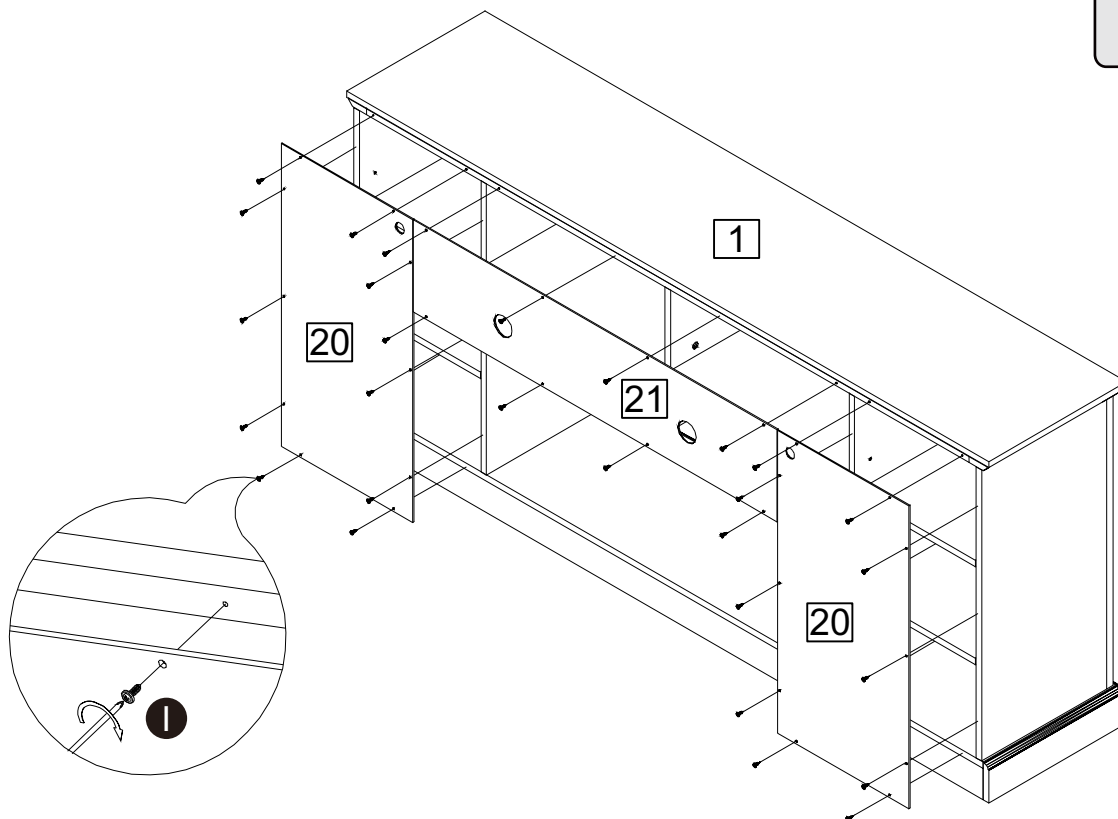

I 
I x 28

Assembly Instructions

Step 31

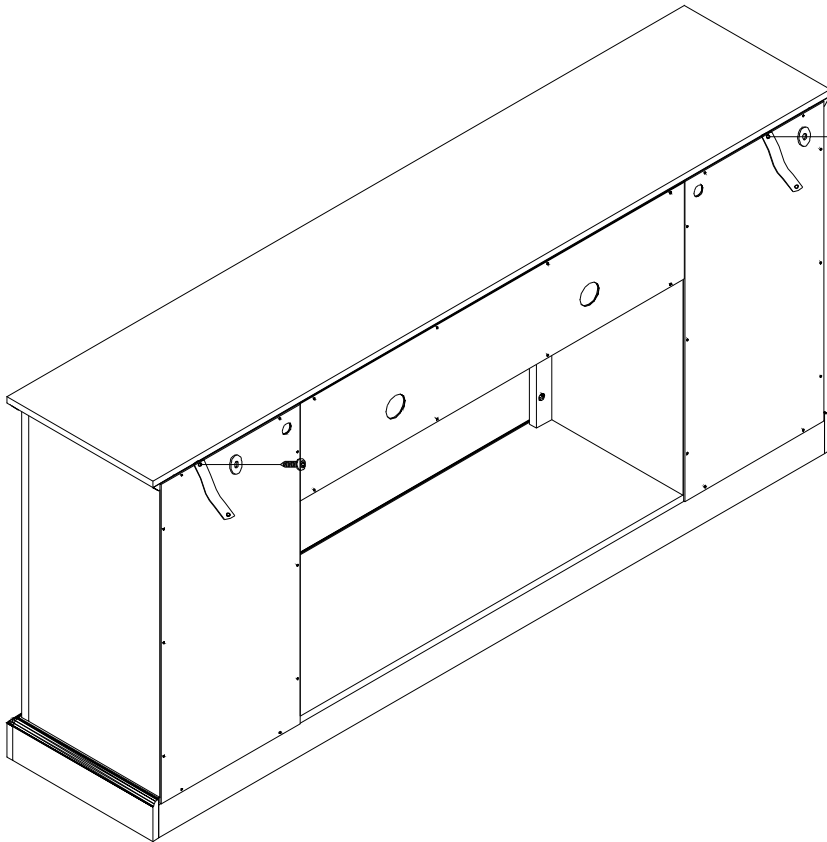

Step 32

