

EXECUTIVE CHAIRS

USER MANUAL

We continue to be committed to provide you tools with competitive price. "Save Half", "Half Price" or any other similar expressions used by us only represents an estimate of savings you might benefit from buying certain tools with us compared to the major top brands and does not necessarily mean to cover all categories of tools offered by us. You are kindly reminded to verify carefully when you are placing an order with us if you are actually Saving Half in comparison with the top major brands.

EXECUTIVE CHAIRS



NEED HELP? CONTACT US!

Have product questions? Need technical support? Please feel free to contact us:

This is the original instruction, please read all manual instructions carefully before operating. reserves a clear interpretation of our user manual. The appearance of the product shall be subject to the product you received. Please forgive us that we won't inform you again if there are any technology or software updates on our product.

SAFETY INSTRUCTIONS

WARNING:

Read this material before using this product. Failure to do so may result in serious injury.

Assembly precautions









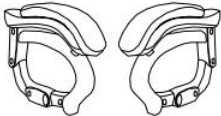
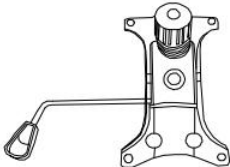

1. Assemble only according to these instructions. Improper assembly may create hazards.
2. Wear ANSI-approved safety goggles and heavy-duty work gloves during assembly.
3. Keep the assembly area clean and well-lit.
4. Keep bystanders out of the area during assembly.
5. Do not assemble if tired or when under the influence of alcohol, drugs or medication.
6. The product capabilities apply to properly and completely assembled products only.
7. Assemble on a flat, level, hard and smooth surface capable of safely supporting the executive chairs.
8. For additional information regarding the parts listed in the following pages, please refer to the Assembly Diagram of this manual. Unwrap and separate all parts in a clean work area.

Use precautions

1. Do not exceed specified weight capacities.
2. Use only on a flat, level, hard, and smooth surface that can safely support a fully loaded executive chairs.
3. Use as intended only.
4. Inspect before every use; do not use if parts are loose or damaged.

SAVE THIS MANUAL

PARTS LIST

<p>A *1</p> 	<p>B *1</p> 	<p>C *2</p> <p>R L</p> 
<p>D *1</p> 	<p>E *1</p> 	<p>F *1</p> 
<p>G *1</p> 	<p>H *5</p> 	<p>J *1</p> 
<p>K *8</p> 	<p>M *12</p>  <p>M6*25mm</p>	<p>N *2</p>  <p>M6*20mm</p>

ASSEMBLY STEP

STEP 1

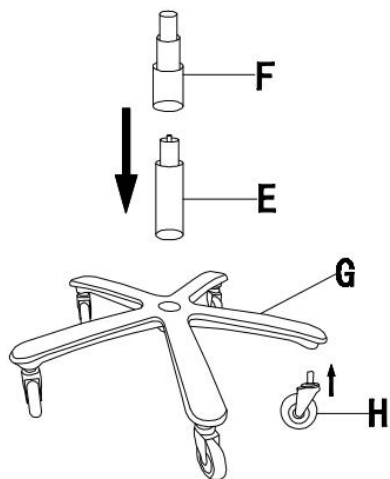

STEP 2

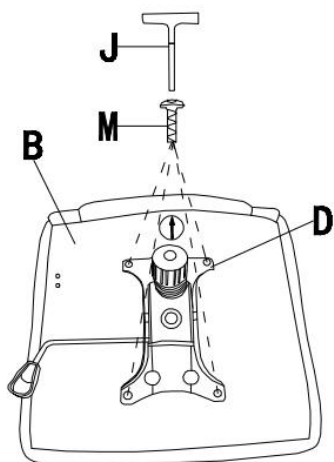

STEP 3

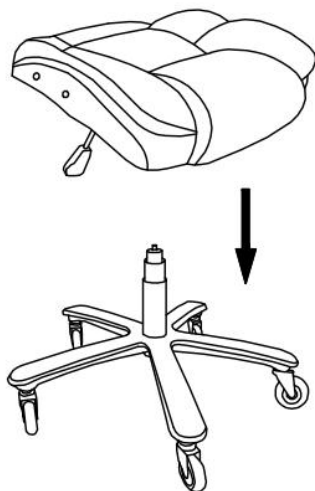

STEP 4

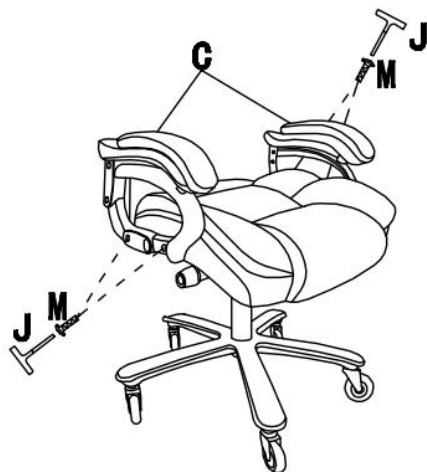

STEP 5



STEP 6

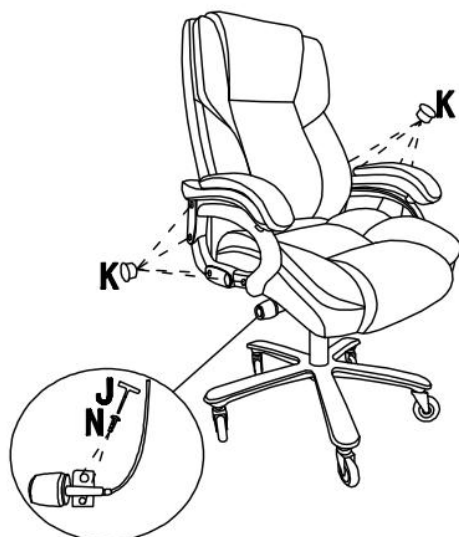

PRODUCT PARAMETER

Model	
Colour	Black
Lifting Range	100 mm
Safe Loading Weight	500 lbs
Product Size	W685*D774*H1288 mm

*Products such as specifications, appearance, and design are subject to modification without prior notice.