

(Weight Limit 20KGS)

This toy is unsuitable for children under 2 years.

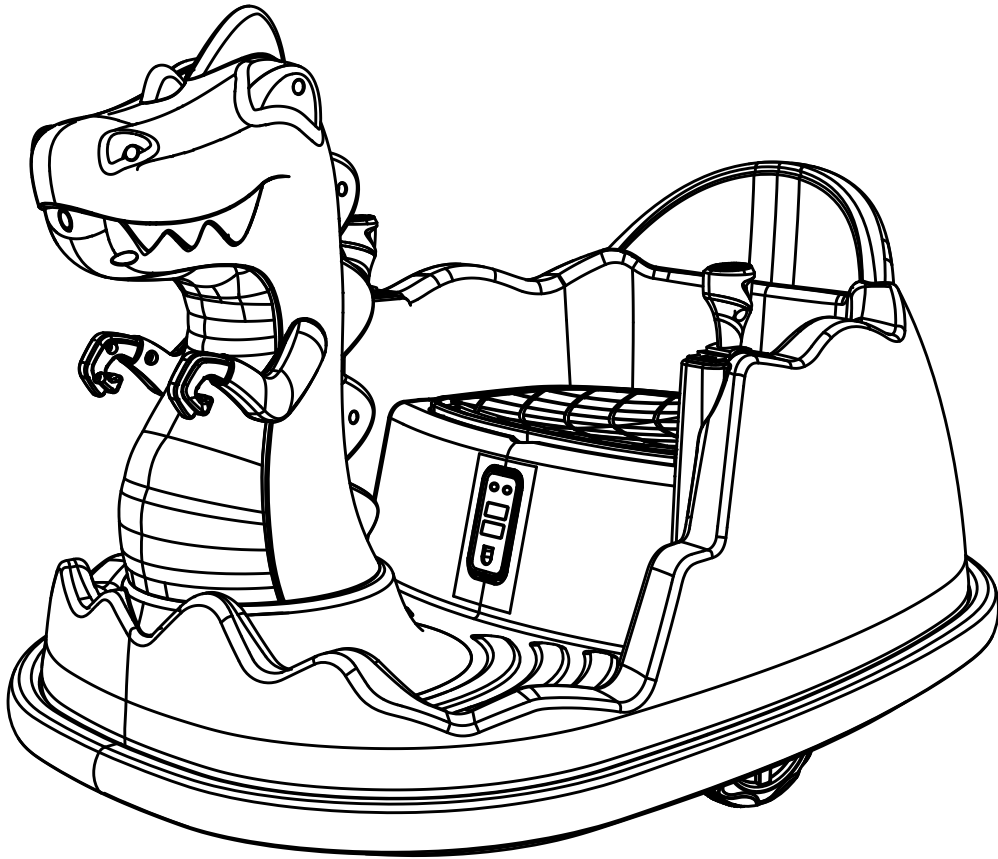

Ride On Car

Owner's Manual with Assembly Instructions

WARNING: ASSEMBLY SHOULD BE DONE BY ADULTS



•To reduce the risk of injury, adult supervision is required. Never use it on roadways, near motor vehicles, steep inclines, steps, swimming pools, or other bodies of water. Always wear shoes and helmets.

•**Limited to one person.**

•**TO PREVENT FIRE AND ELECTRIC SHOCK:**

•Only use batteries and chargers provided or specified by the manufacturer. Using the wrong type of batteries or chargers could cause a fire or explosion.

•**DO NOT** use the batteries or chargers on any other product. Or overheating, fire or explosion could occur.

•**NEVER** modify the circuit system. Alterations could cause a shock, fire or explosion.

•**DO NOT** pour any type of liquid on the batteries or other components.

Explosive gases are produced during charging.

•**DO NOT** charge near heat or flammable materials. Charge in a well-ventilated area ONLY. Charge in a dry area ONLY.

•**DO NOT** open the batteries. Batteries contain lead and other toxic and corrosive materials

•**DO NOT** open the chargers. Exposed wiring and circuitry may cause electric shock

•**ONLY ADULTS** can handle or charge the batteries. NEVER allow child to handle or charge the batteries. Batteries are heavy and contain lead acid (electrolyte)

•**DO NOT** drop the batteries. Otherwise permanent damage or other serious injury to the batteries would occur.

•Before charging, check the wear and damage of the battery, charger and the connectors.

•**DO NOT** charge the battery if any damage to parts has occurred. Please contact the dealer or manufacture to replace the parts ONLY.

•**DO NOT** allow the battery to drain completely; charge the battery after each use or at least once a month if not used regularly.

•**DO NOT** charge battery upside down.

•Always make sure that the battery is fixed with the bracket. Otherwise, battery can fall out and even injure a child if the vehicle tips over. Risk of fire. Do not bypass.

•**If a battery leaks**, avoid it from contacting with the leaking acid and put the damaged battery into a plastic bag. Refer to information in "Disposal of Battery" for proper disposal.

•**If acid comes in contact with skin or eyes**, **rinse** with cool water for at least 15 minutes and call for a doctor.

•**If mistakenly take a large number of acid**, **take a large amount of** water, milk of magnesia or egg-white immediately. Call a physician.

MADE IN CHINA

Specification instruction





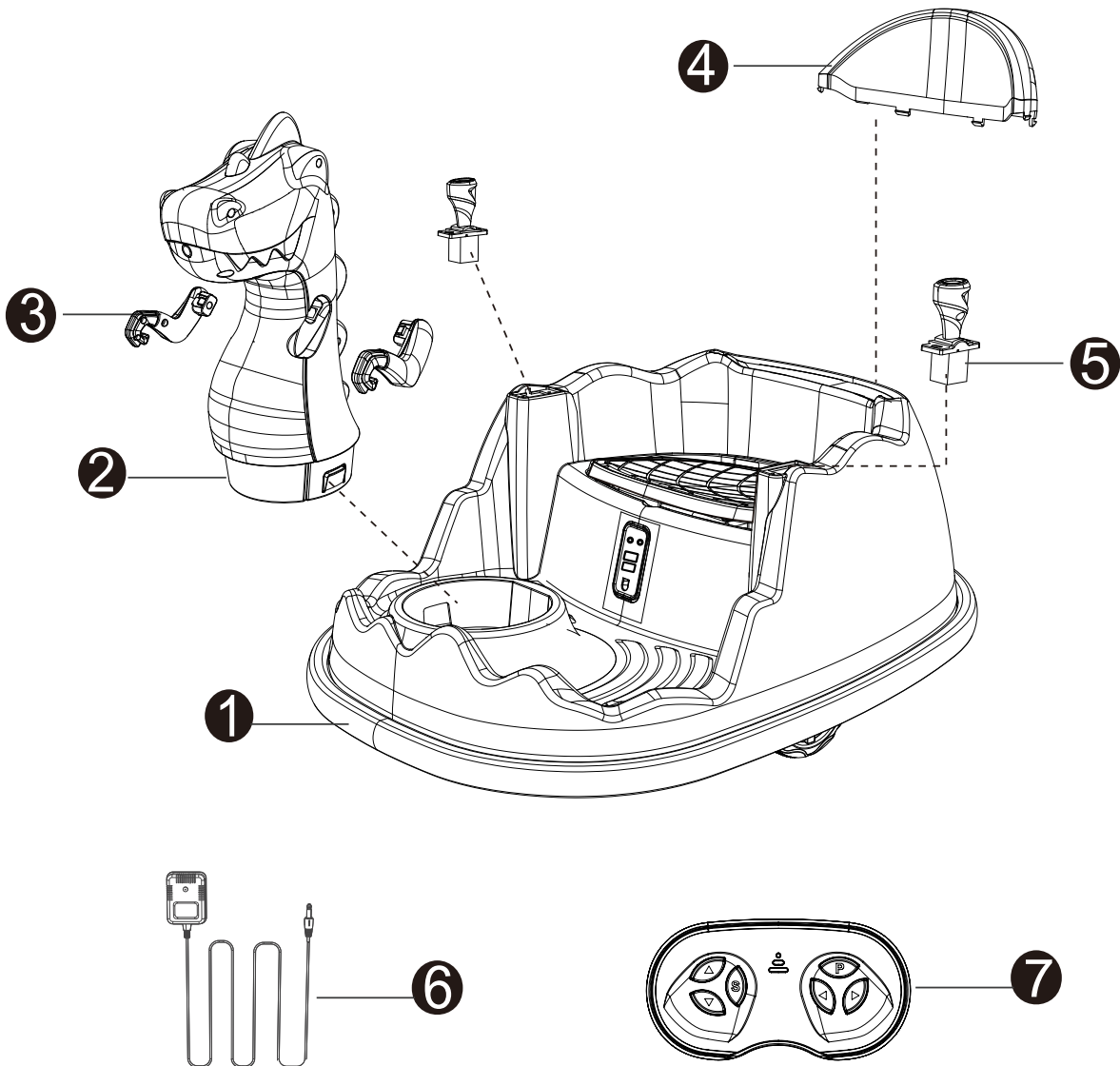

Name	Specification
Battery	12V4.5AH*1
Motor	12V380*2
Applicable age	2-5 years old
Maximum load	20KG
Charge time	Charge 8-12 hours
Charger	12V500mA

※Above parameters are selected for customers, the specific parameters is based on the actual parameter

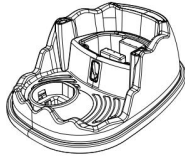
Parts List

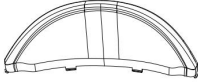
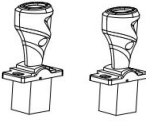

Parts List

No.	Name of accessory	Picture	Qty
1	Bumper Car		1
2	Dinosaur head		1
3	Dinosaur claws(L/R)		1
4	Seat backrest		1
5	Control levers(L/R) (On the bumper car)		1
6	Charger		1
7	Remote controller		1
8	4*12mm screw		4

Owner's Manual with Assembly Instructions

WARNING: To reduce the risk of injury, adult supervision is required. Never use in roadways, near motor vehicles, on or near steep inclines or steps, swimming pools or other bodies of water; always wear shoes, and never allow more than 1 rider(s).

WARNING: ASSEMBLY SHOULD BE DONE BY ADULTS

Installation instructions

1. Install the control levers

Secure the left and right control levers with 2pcs screws each (4*12mm).

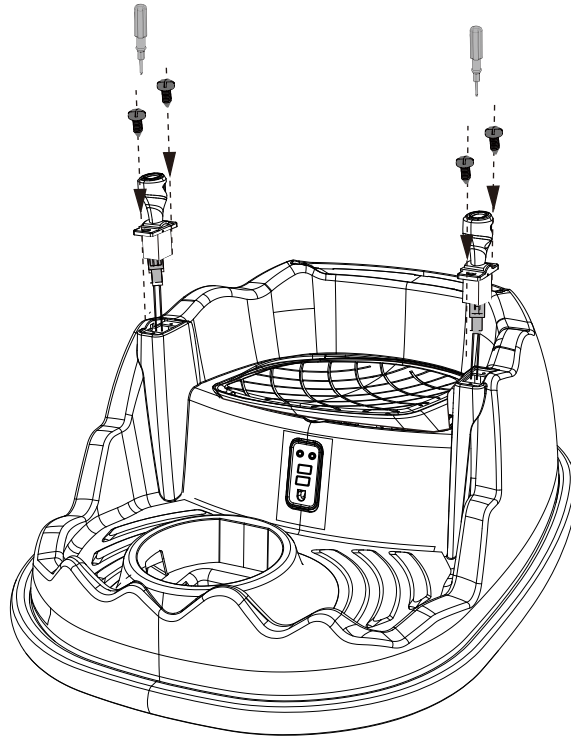

2. Install the backrest

Align the seat backrest with the vehicle body and insert it for fixation.

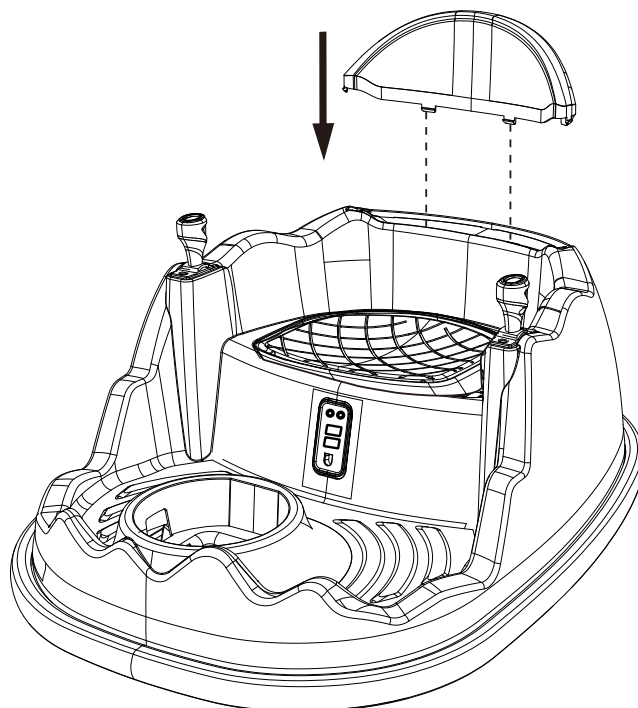

3. Install the dinosaur head

1. Align the left and right dinosaur claws with the dinosaur head and insert them to secure.

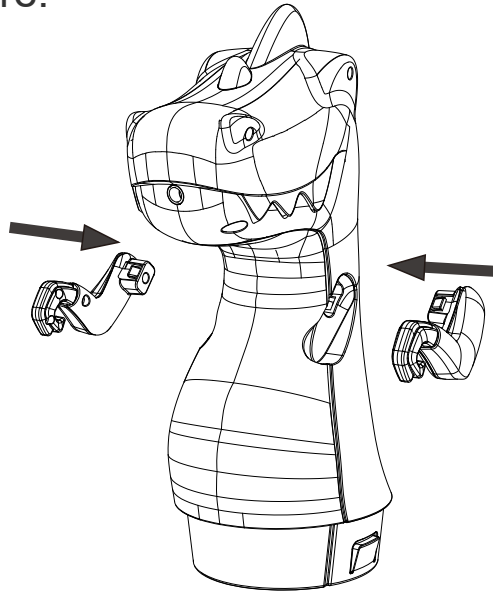

2. Connect the connector on the bottom of the dinosaur head to the body connector.

3. Align the dinosaur head with the vehicle body and insert it for fixation.

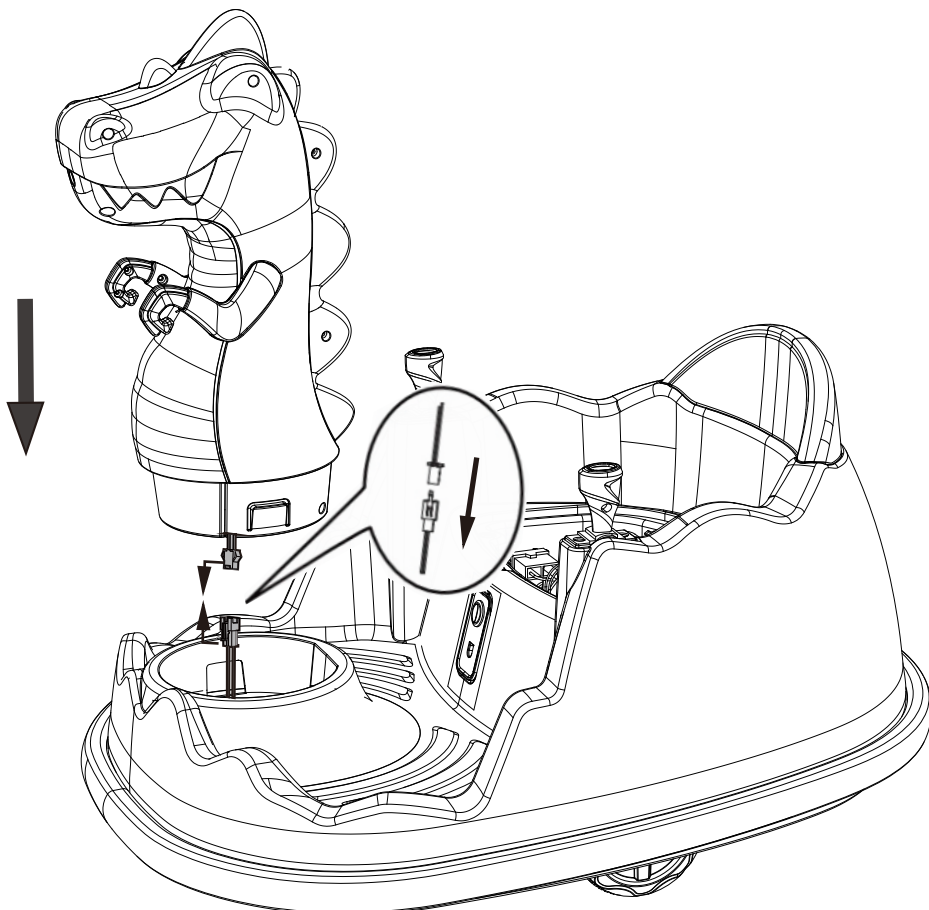

4. Connecting the power

1. Remove the two screws on the seat and take off the seat.

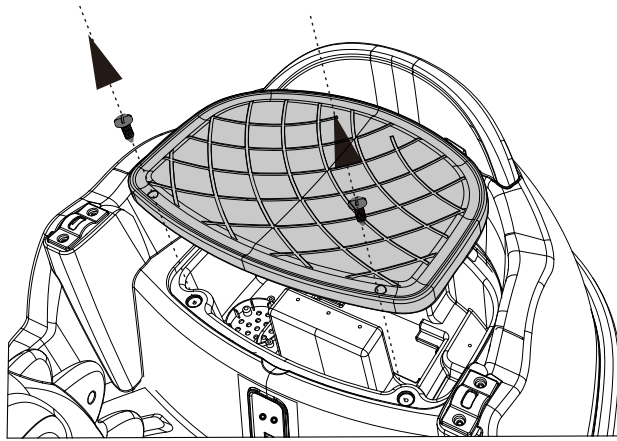

2. Remove the protective sleeve (white plastic) from the battery, plug the power connection cable into the battery connector (red wire to red wire, black wire to black wire) and power on.

3. Finally the seat is secured with two screws.

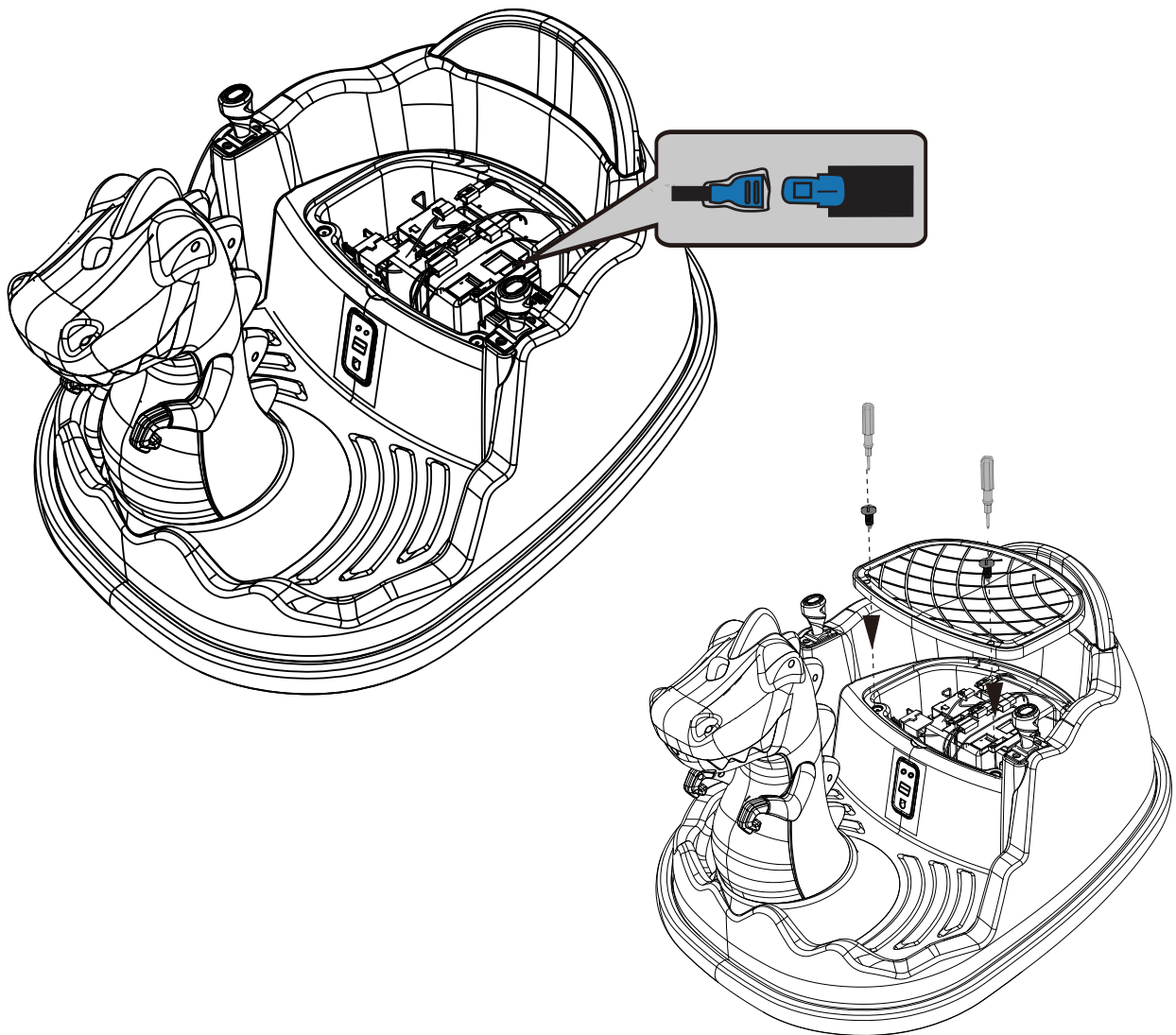

This product is packed with the battery disconnected.
Connect the battery before use.

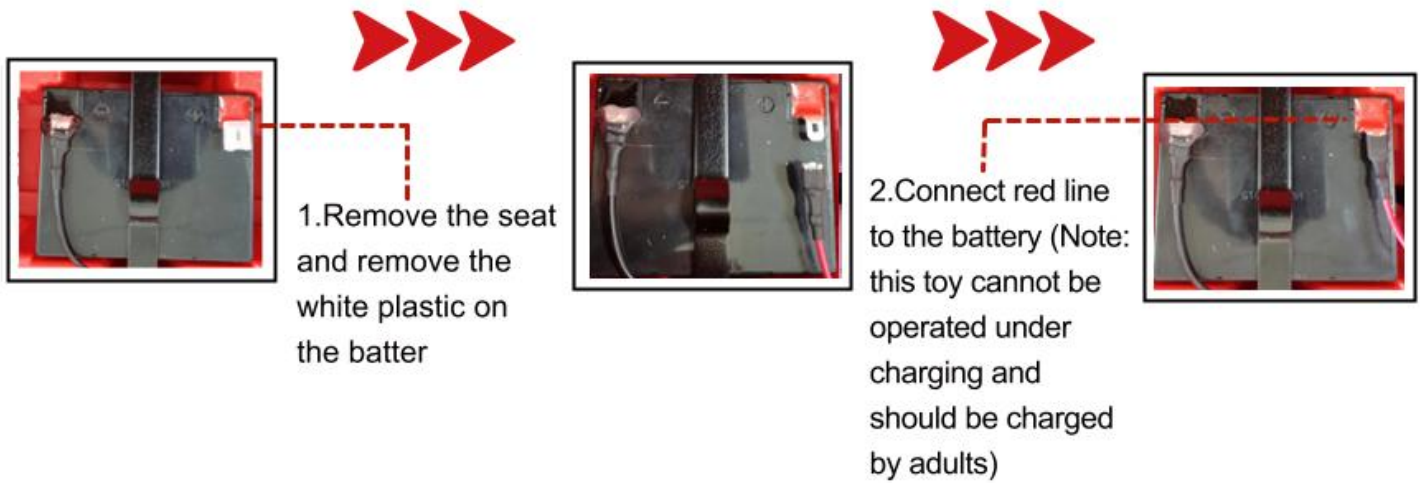

WARNING:

1. When the electric car is unused for a long time, it must be charged at least once a month.
2. For every hour of use, it must be timely charged. The normal charging time is 8-12 hours, and the charging time shall not exceed 20 hours.
3. The charger and battery are not toys. Children are not allowed to play with them.

2. Installation and using of the remote controller

① **Install battery:** open the battery cover which is in the remote control, install two pieces of AAA (1.5V)(#7) dry batteries, pay attention to the polarity of battery before installing. Put on the battery cover and use Screws to fix (please follow above steps when renewing the battery, only adults can renew it. Please don't mix the new and old batteries or different batteries. Please take away the exhausted batteries from the toys in time.)

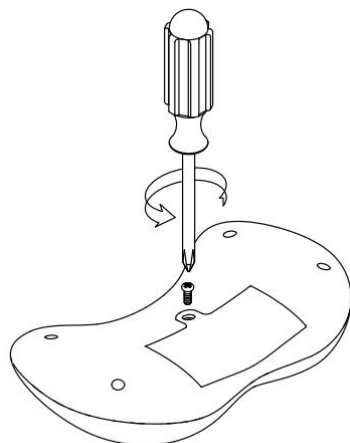

Loosen a screw

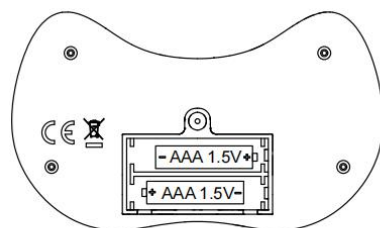

Load two AAA(1.5V) batteries

②use method:

The remote control needs to be paired for first-time use. It has a memory function, so when you replace the batteries, you do not need to pair it again.

- ①.Long press "S" button more than three seconds, Until the LED lights flashing.
- ②.Open the car body power now, The LED turns on the success of the code.
- ③.Remote control 10 seconds without operating automatic standby, press any key to wake up.
- ④.Key Description: "▲" Forward, "▼" Back," ◀" Left, "▶" Right, "S" Code, "P" Brake.Press the "P" key to keep the brakes, the indicator flash, press the "P" key again to lift the brake.

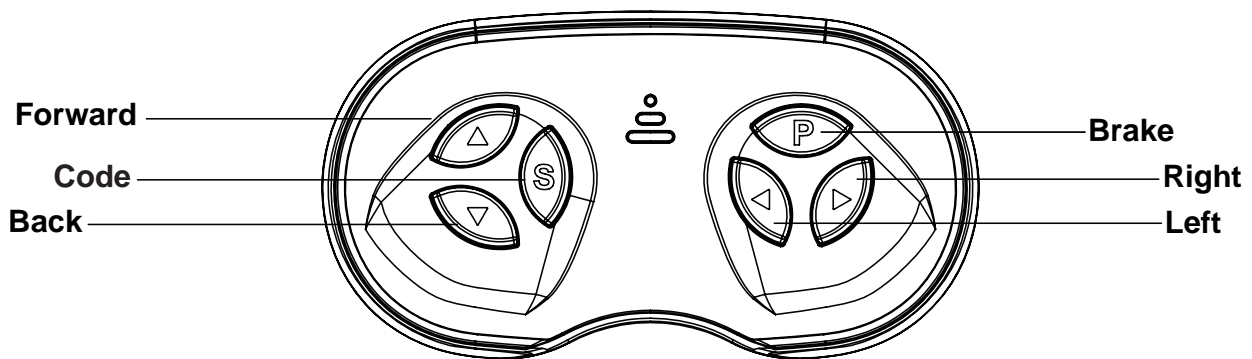

WARNING!

- 1.Not for children under 2 years old. Small parts. Choking hazard.
- 2.The remote controller only can be used with adult's guidance.
- 3.Load two AAA(1.5V)batteries according to the diagram.
- 4.Non-rechargeable batteries must not be recharged.
- 5.Different types of batteries or new and used batteries are not to be mixed.
- 6.Batteries are to be inserted with the correct polarity.
- 7.Exhausted batteries are to be removed from the toy.
- 8.The supply terminals are not to be short-circuited.
- 9.Should take away the exhausted batteries from the toys, and handle well, prevent played by children and caused harm.
- 10.The packaging must be retained since it contains important information.

Function

Button function

- ① **Left and right control levers:** the left control lever is pushed forward to turn right and backward to turn left, the right control lever is pushed forward to turn left and backward to turn right. Left and right control levers are pushed forward at the same time to go forward, and pushed backward at the same time to go backward.
- ② **Music button:** switches the song.
- ③ **Power switch:** Press '1' to switch on the power, press '0' to switch off the power.
- ④ **Spray Switch:** Press to switch on the spray.
- ⑤ **Charging hole:** Charging (Disconnect the charging port before turning car on, Car won't start while charging)
- ⑥ **Spray water filler:** Open the lid and add water to it for spraying.
- ⑦ **Spray port:** Here can be sprayed.

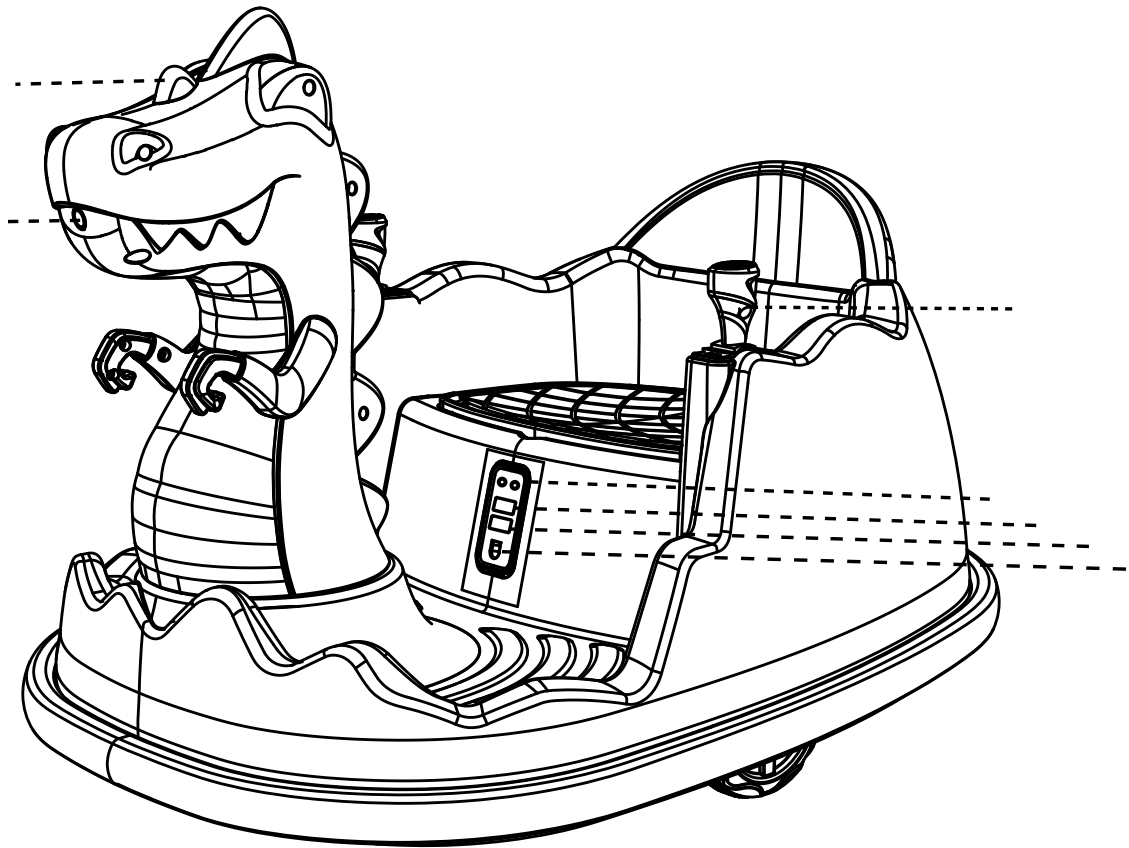

Maintenance

- 1.To guarantee that your baby will not be hurt unexpectedly, please frequently check and maintain this car.
- 2.Check if all parts are included before assembly. Contact us immediately if anything is missing.
- 3Check regularly for loose screws or damaged parts.
- 4.Please frequently check whether it is intact when each part is installed or used
- 5.When disassembling, please operate according to the operating specification carefully to avoid to cause unnecessary damage.
- 6.Please check product and the charger used on a regular basis, check whether wire, plug, outer shell and other parts are damaged and you should stop use if find damage, till it is repaired well.
- 7.Please do cleaning for this product at a regular time, fill lubricating oil into rotating parts. Be careful not to damage the electric elements, don't use water to wash, use dry cloth to wipe.



Warning

To make your baby safety driving, you must pay attention on the below warnings:

- 1.Assemble and adjustment of products must be done by adult, please make children far away from the motion parts.
2. Small parts in it, which is not suitable to be used by the children under 2 years old!
3. Must correctly use the life belt when children sits. Don't close to fire!
4. The children must use this product under the guidance of adults, and the guardian can't leave during the using process!
5. Don't allow the children stand or play on the foot pedal(or in the electric car).
- 6.charging the storage battery must be done by adults. Please charge at first before use this product!
- 7.To prevent injury, keep packaging materials like plastic bags away from children!
Asphyxiation hazard!
8. Strictly forbidden to use any accessories which are not provided by manufacturer.
9. Do not use chargers as toys.
10. The maximum load of this car is 20KG, can't overload.
11. The suitable age scope of this car:2-5 years old.
12. The toy can't connect to too many power supplier which exceeds the recommend numbers.
13. The toy(complete car) can't be operated during charging.

Notices for charging

1. When use the electric car for the first time, the user must guarantee the positive and negative pole of power supply have already correctly connected (the storage battery installed in the engine plate at the front of car, pay attention to different positive/negative poles when connects, needs red to red, black to black). Ensure that the storage battery is charged for at least 8 hours. Otherwise, it may suffer permanent damage that cannot be repaired.
2. Plug the DC plug of charger into the charge hole at first, then plug the charger into power outlet.
3. Must charge in time after using about one hour each time, the normal charge time is from 8 to 12 hours, and charge time for every time can not exceed 20 hours.
4. During the charging process, it is normal for the charger temperature to be lower than 60°C, and normal for the storage battery temperature to be lower than 45°C.
5. If there is stagnant water in the connect/plug part, it can't charge, otherwise it maybe cause short circuit.
6. This electric car must use the charger and storage battery configured with this car to avoid to damage the charge and storage battery or electric circuit.
7. charge at least once a month. if don't use the electric car for a long time, please plug out the connect/plug part of storage battery.

Use notices

1. Please check whether all parts are installed on position, tightly connect before use.
2. Can't use in the dangerous area like streets, roads, slopes and ditches, etc.
3. Please don't used it on smooth ground, for example marbles, ground tiles, etc.
4. Don't shift forward/backward switches when the electric car is running. Please note that don't allow children to stand on the seat.
5. Don't change the circuit and additional electrical devices of this car.
6. The remote controller and electric car can't be used in rain or water, don't pour the water or other liquid on the car or other places to make it soaking and make it far away from the fire source to avoid to cause circuit damaged.
7. Electrical car stops running when it touches hinder, please run after leaving the hinders.
8. Don't use in room to avoid to crack up the furniture even though make the children tumble.
9. When the quantity of electricity of battery of remote controller is not enough, it will occur that the complete car can only remote forward, can't remote left/right direction, shortens remote distance and shakes, please renewal battery in time.
10. Please shut off the power supply switch when don't use it, please plug out the connect/plug parts of storage battery.
11. This product limits to one people, can't be overloaded, the maximum load is 20kg.

Note: the product picture, functional and introduce in this specification only for reference, project to the physical entity.