

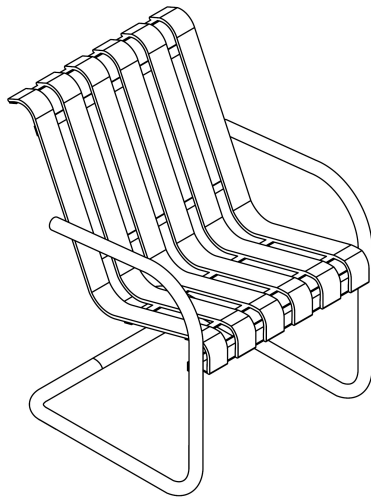

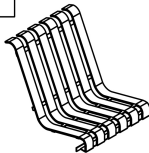





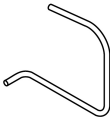

Stainless Steel Chair

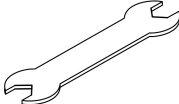

PARTS LIST

			
<p>Back and Seat 1 PC</p>	<p>Left Support Leg 1 PC</p>	<p>Right Support Leg 1 PC</p>	<p>Leg Connector 1 PC</p>

HARDWARE

 <p>M6X40mm</p>				
<p>Bolt 4 PCS</p>	<p>Nut 4 PCS</p>	<p>Flat Washer 8 PCS</p>	<p>Wrench 1 PC</p>	<p>Allen Key 1 PC</p>
				
<p>Foot Cap 2 PCS</p>	<p>Plastic Washer 2 PCS</p>	<p>Cross Head Bolt 2 PCS</p>		

IMPORTANT NOTE: WE RECOMMEND TWO PEOPLE WORK TOGETHER TO ASSEMBLE THE CHAIR

ADDITIONAL TOOLS (Not Provided)

Note: It is not recommended to use power tools during assembly.

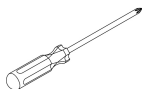

Step 1. Attach left support leg (part #2) and right support leg (part #3) using leg connector (part #4).

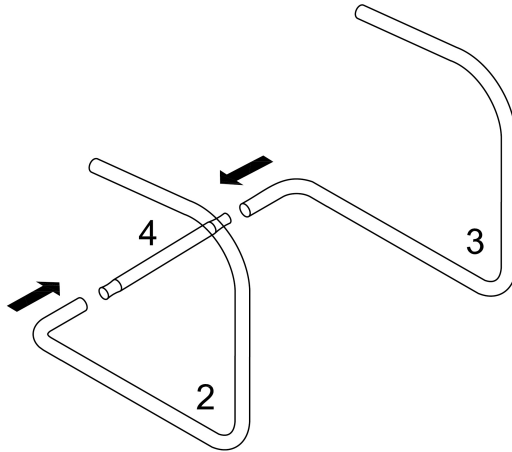

Step 2. Attach foot caps (part F) into the pre-drilled holes on the bottom of the support legs (parts #2&3) and leg connector (part #4) using cross head bolts (part H) and Phillips head screwdriver.

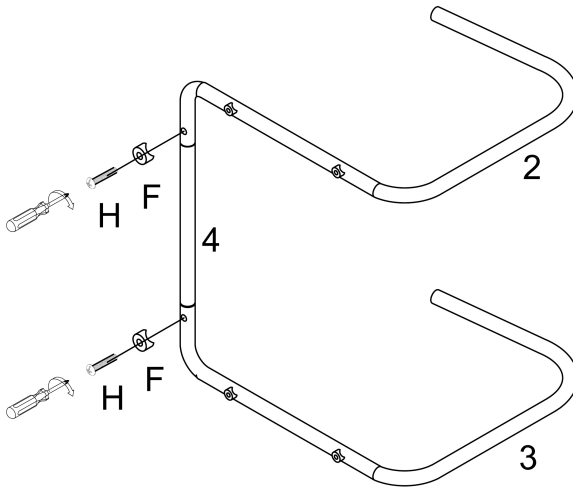

F  X 2
H  X 2

Step 3. IMPORTANT: Only attach support legs (parts #2&3) to SEAT portion of back and seat (part #1) where shown. Do not attach support legs (parts #2&3) to BACK portion of back and seat (part #1) until instructed!





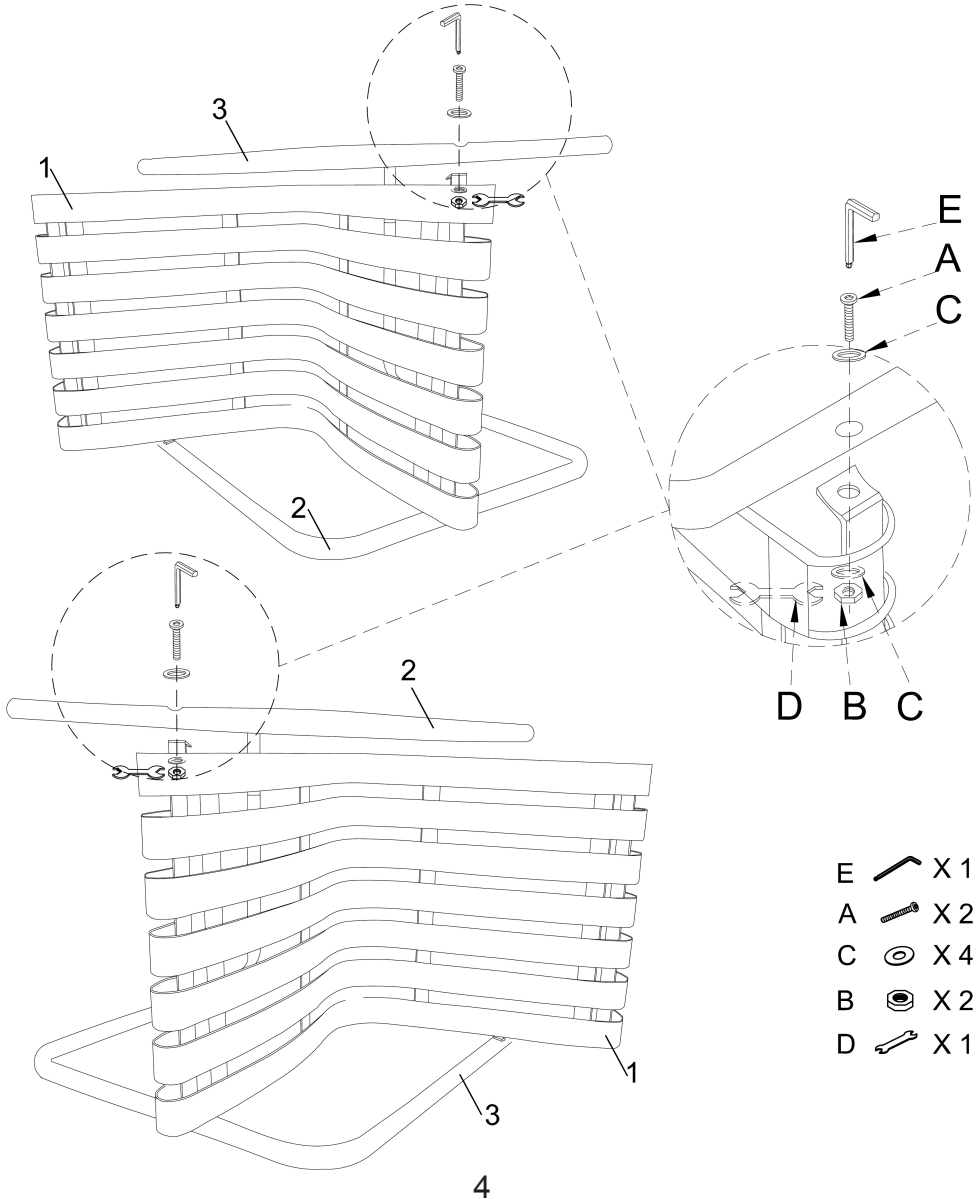

Attach seat (part #1) to support legs (parts #2&3) using bolts (part A), flat washers (part C), nuts (part B), wrench (part D) and allen key (part E).

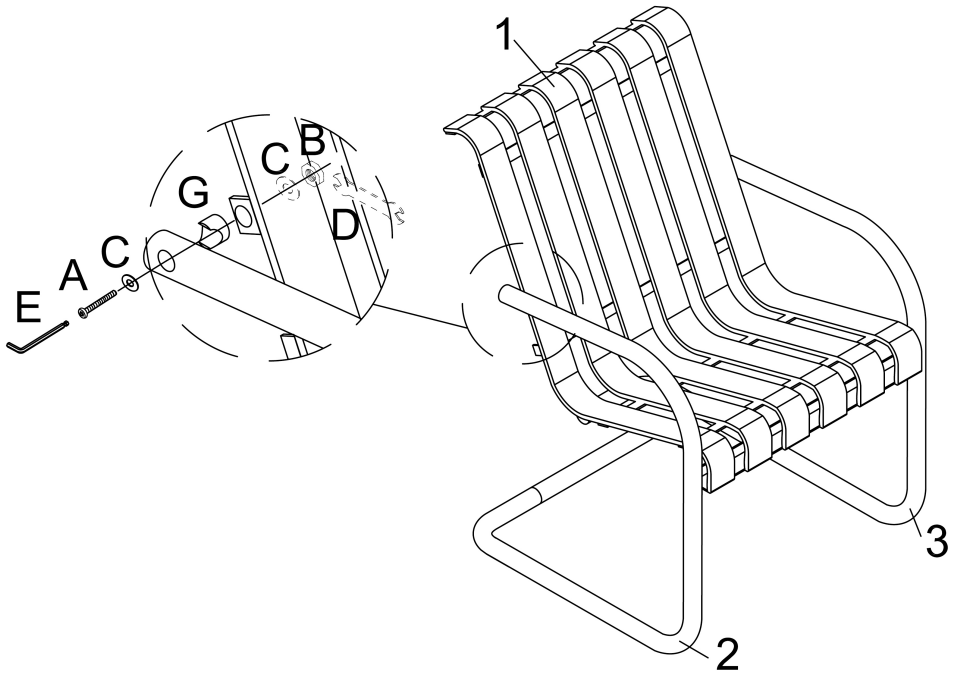
Note: Please make sure support legs (parts #2&3) are properly aligned and flush with the bottom rail of the seat (No gaps) before fully tightening all bolts. Hold nuts (part B) in place with wrench (part D) and turn bolts (part A) with allen key (part E) to tighten.



Step 4. NOTE: It may be necessary to apply pressure and force the back and seat (part #1) into position. Attach support legs (parts #2&3) to back (part #1) using bolts (part A), flat washers (part C), plastic washers (part G), nuts (part B), wrench (part D) and allen key (part E). Please fully tighten all bolts.



- A  X 2
- C  X 4
- B  X 2
- G  X 2
- D  X 1
- E  X 1