

Owner Manual

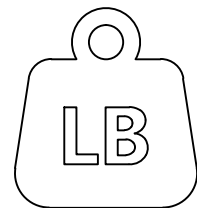
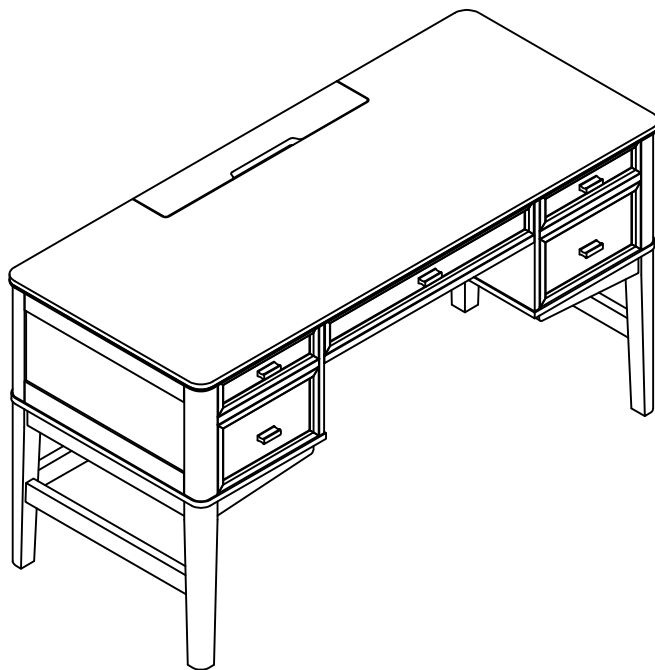

Per Seat Weight Limitation

150 LBS

NOTE:





This brochure contains
IMPORTANT safety info.
Please read and keep it
for future reference.

MAINTENANCE AND WARNINGS



Before You Start

Please follow the steps below:

-  Check the packaging for any damage, deformation, or water stains. If there is significant damage, please contact us promptly.
-  Open the packaging and confirm that the panels, hardware, screws, etc are complete.
-  Please read the installation instructions carefully to understand the installation steps and precautions to ensure proper installation.
-  Clean the installation area in advance and ensure the ground is level and there is enough space to avoid damaging the furniture or making installation difficult.
-  Lay a protective mat on the ground to prevent scratching the floor during installation.

After-Sales Service

- If you encounter any issues or need technical support during use, please contact our after-sales team. We offer long-term maintenance and warranty services.



Precautions

- ⚠ This product for indoor use only. Do not expose it to outdoor elements or high-humidity environments.
- ⚠ Keep the product away from high heat or open flames to prevent fire hazards.
- ⚠ Do not allow children to climb on the product to prevent personal injury caused by tipping



Safety Warnings

- ⚠ If you notice any loose or damaged parts, stop using the product immediately and contact customer service.
- ⚠ Do not attempt to disassemble or replace any components yourself, as this may affect the stability and safety of the product.

Daily Maintenance

- Regularly clean the surface of the sofa with a soft cloth to prevent dust accumulation.
- Do not use cleaning agents containing acids, alkalis, or corrosive substances, as they may damage the surface. It is recommended to use neutral cleaning agents or specialized furniture cleaners
- Avoid exposing furniture to humid environments for extended periods to prevent swelling or deformation of the boards. Use a dehumidifier or desiccant during humid weather.
- Avoid direct contact of furniture with water. If water is accidentally spilled, wipe it dry immediately.
- Avoid placing excessively heavy objects on the furniture: ensure the weight is within a reasonable load-bearing range.
- Avoid using sharp or rough items on the furniture surface to prevent scratches, Handle items gently when moving them

Explosive view

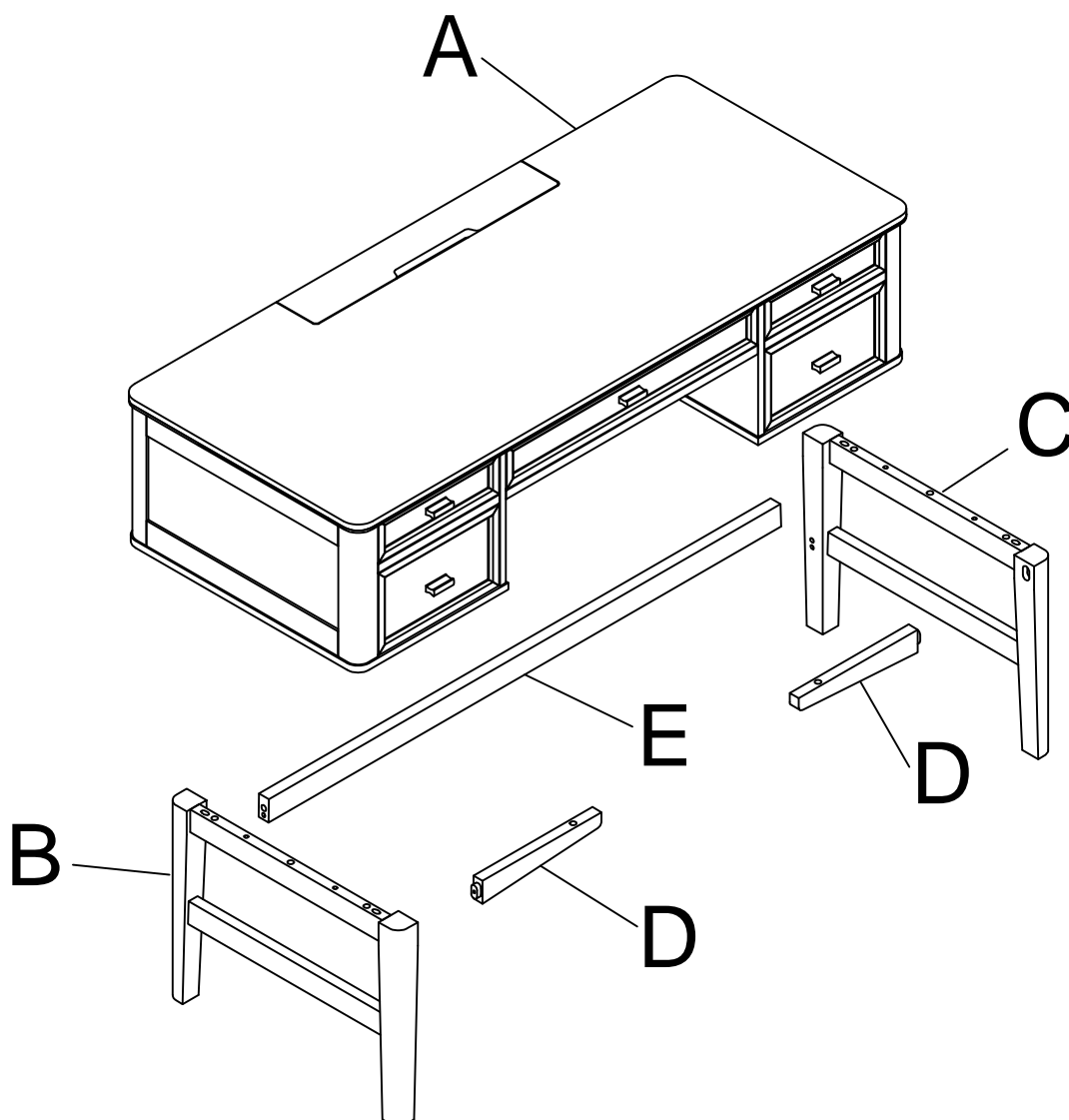

Parts list

A

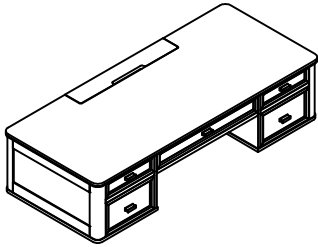

x1

B

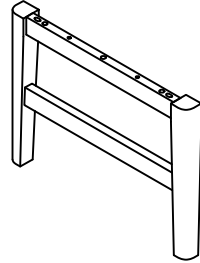

x1

C

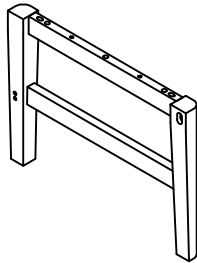

x1

D

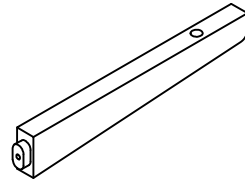

x2

E

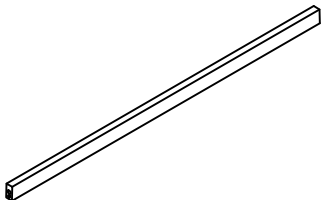

x1





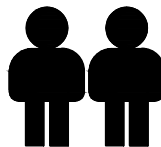

Installation:
15minutes.

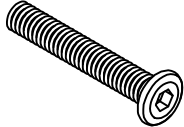
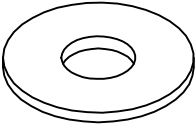
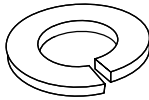
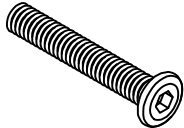
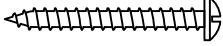

Two Person

Hardware List

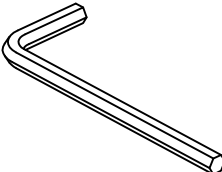
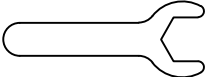
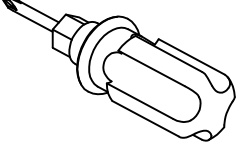
<p>①</p>  <p>x6</p> <p>Ø5/16"*57mm</p>	<p>②</p>  <p>x8</p> <p>Ø5/16"</p>	<p>③</p>  <p>x10+1</p> <p>Ø5/16"</p>
<p>④</p>  <p>x2</p> <p>Ø5/16"*38mm</p>	<p>⑤</p>  <p>x2</p> <p>Ø8*38mm</p>	<p>⑥</p>  <p>x2</p> <p>Ø5/16"</p>
<p>⑦</p>  <p>x2</p> <p>Ø5/16"</p>	<p>⑧</p>  <p>x2</p> <p>Ø5/16"*76mm</p>	<p>⑨</p>  <p>x1</p> <p>M4</p>
<p>⑩</p>  <p>x1</p> <p>Wrench 12mm</p>	<p>⑪</p>  <p>x1</p> <p>Not including</p>	

Step 1

1. Insert part (D) into part (B&C), make sure align aligned then use screw (5) to attach them screw driver (11).

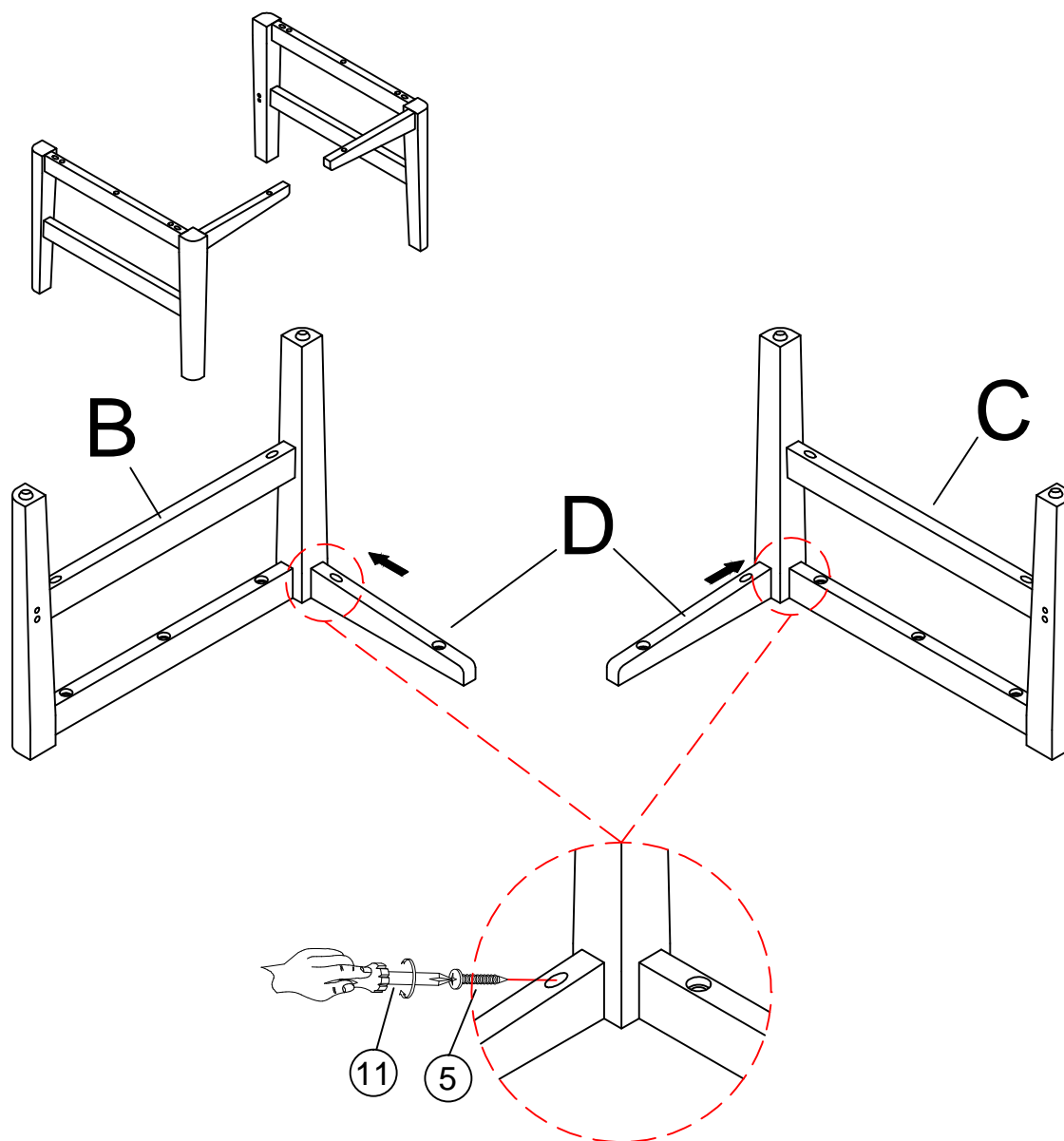



(5)	x2	(11)	x1
Ø8*38mm		Not including	

Step 2

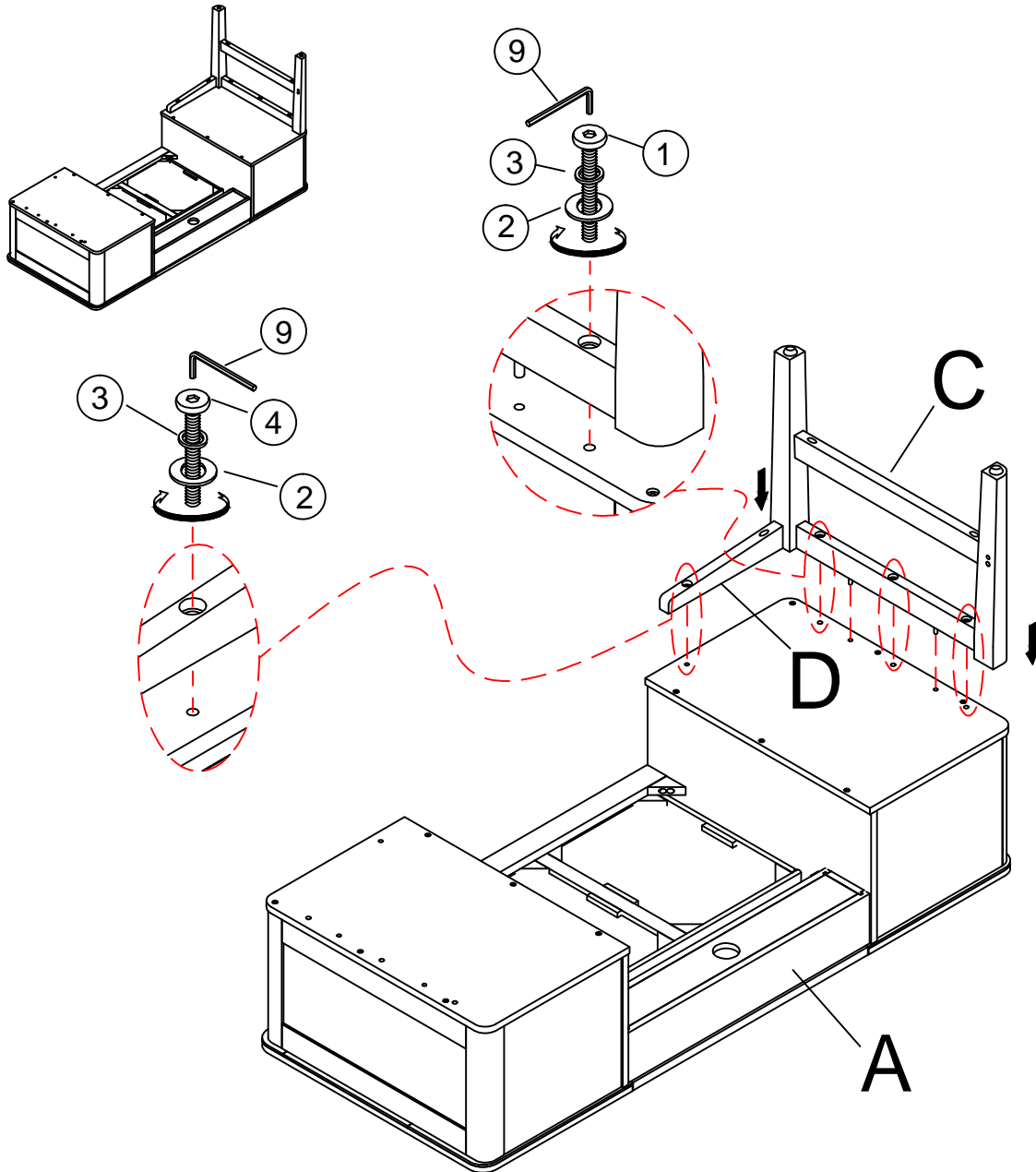
1. Insert part (C&D) into part (A), make sure all holes align aligned using bolts (1) & bolt (4), then tighten the bolt with an Allen key (9).

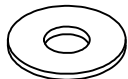

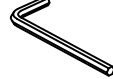
①	x3	②	x4	③	x4	④	x1	⑨	x1
									
Ø5/16"*57mm		Ø5/16"		Ø5/16"		Ø5/16"*38MM		M4	

Step 3

1. Insert part (E) into part (C) make sure all holes align aligned using half moon washer (6) & Lock Washers (3) & hex nut (7), then tighten the hex nut with an wrench (10).

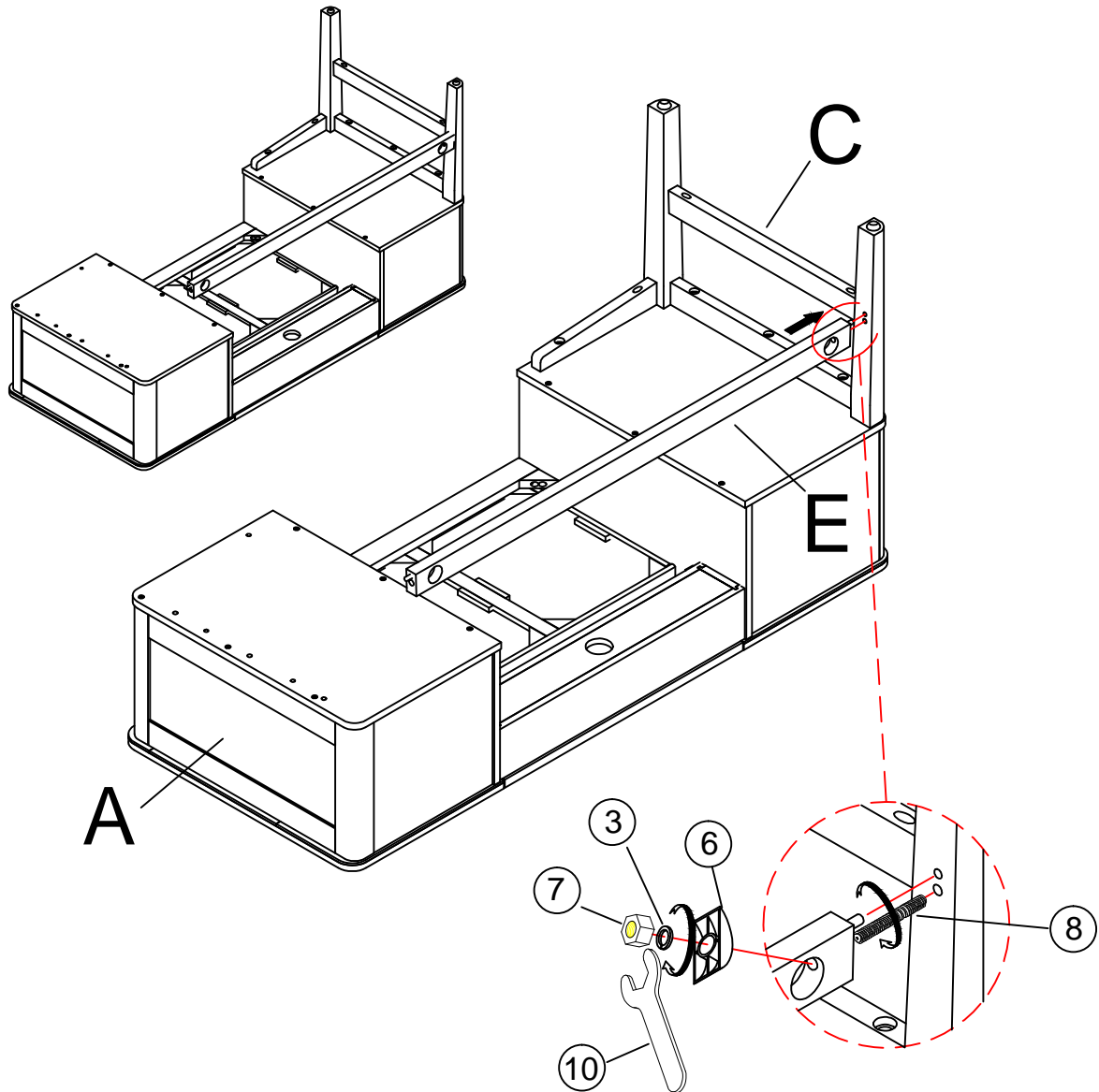







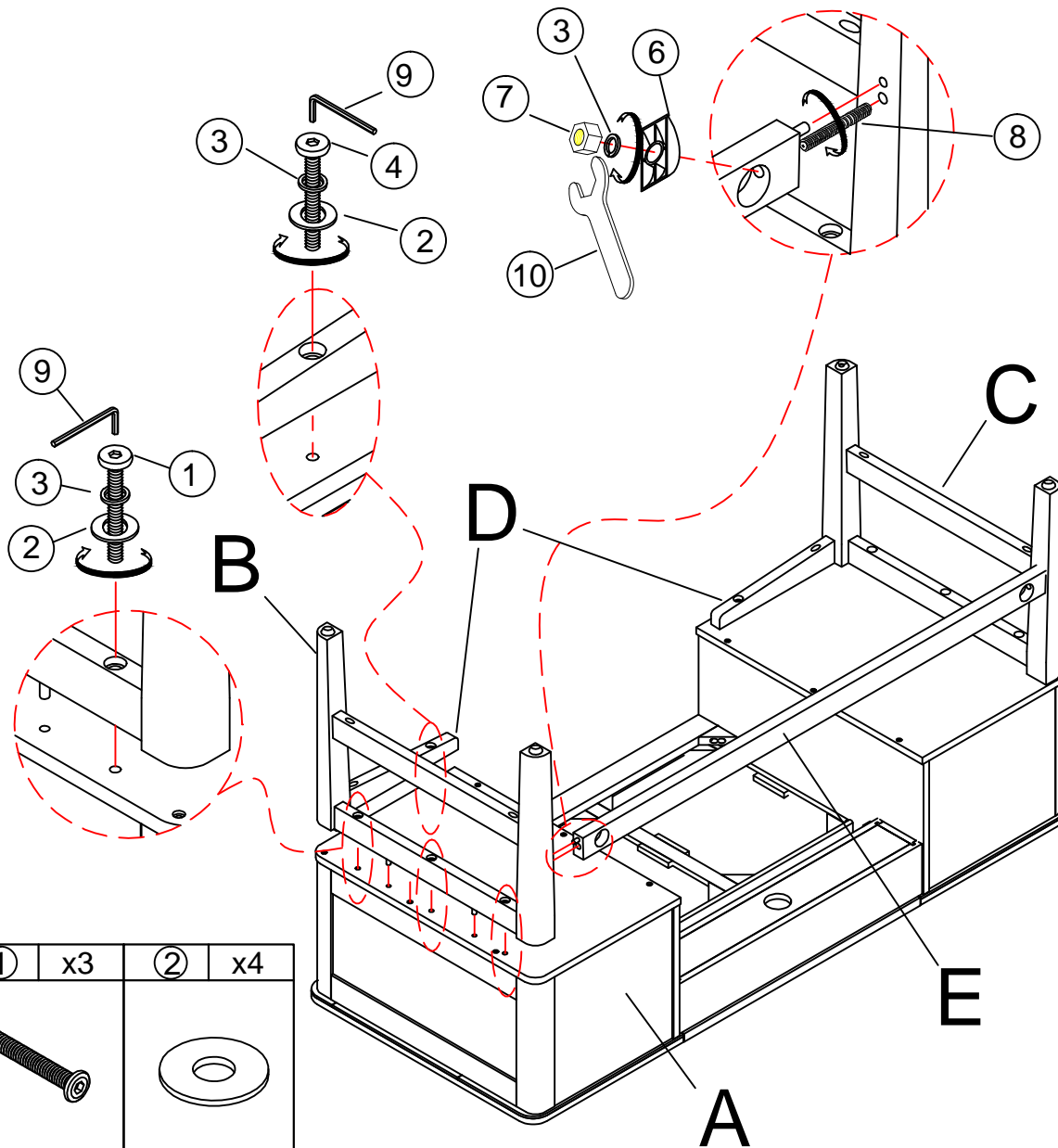

③	x1	⑥	x1	⑦	x1	⑧	x1	⑩	x1
Ø5/16"		Ø5/16"		Ø5/16"		Ø5/16"*76MM		Wrench 12mm	

Step 4

1. Insert part (B&D) into part (A&E) make sure all holes align aligned using half moon washer (6) & Lock Washers (3) & hex nut (7), then tighten the hex nut with an wrench (10).

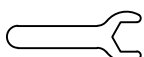

①	x3	②	x4
			
Ø5/16"*57mm		Ø5/16"	

③	x5	④	x1	⑥	x1	⑦	x1	⑧	x1	⑨	x1	⑩	x1
													
Ø5/16"		Ø5/16"*38mm		Ø5/16"		Ø5/16"		Ø5/16"*76mm		M4		Wrench 12mm	

Step 5

1. There is a drawer at the back that can be used as desired.
2. Adjust the leg levelers as needed.

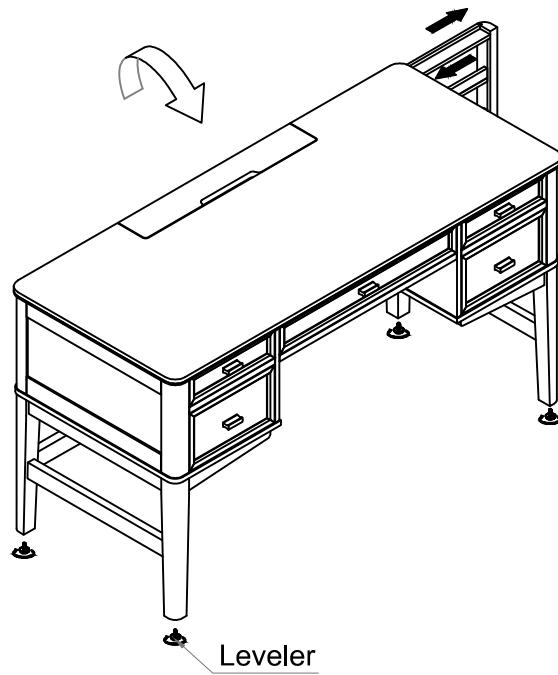

Step 6

1. Complete

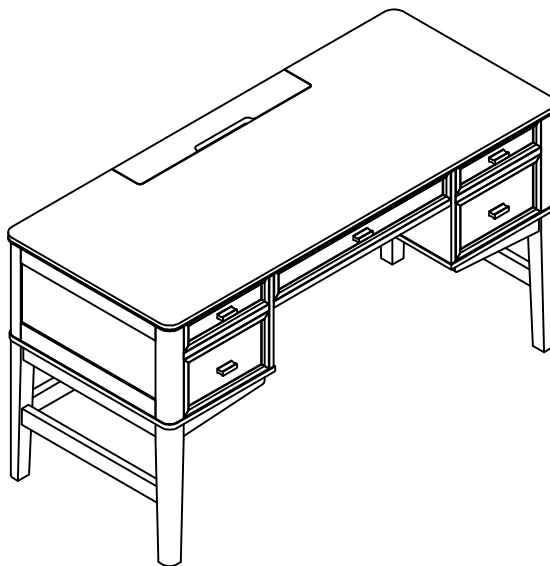

WARRANTY

- We strive to offer quality products, and we also try our best to satisfy every customer who orders from us with products or services as needed.
- We provide 30 days warranty starting from the time you receive the item. Each customer must provide a record of their orders such as the order number, or item receipt for any items that are out of the warranty period you may also still receive.
- Replacement parts by purchasing them from our company if they are available.
- For return, please check the return policy with the retailer or market place you bought from

Appreciate your purchasing from us.
Pop up your life by our furniture piece!