

**40kg**  
**88lb**

## **IMPORTANT INFORMATION!**

We advise that before starting the assembly of this product that you familiarise yourself with the instructions and the parts list in this leaflet.

## **INFORMATIONS IMPORTANTES!**

Nous vous recommandons de vous familiariser avec ces instructions et la liste des pièces détachées contenues dans ce document avant de commencer l'assemblage de ce produit.

## **INFORMACIÓN IMPORTANTE!**

Le recomendamos que antes de comenzar el ensamblaje de este producto se familiarize con las instrucciones y la lista de partes en esta hoja informativa.

### **Do not's**

Do not over tighten any part of this assembly.

Do not place hot or cold objects on to or close next to any glass surface unless the object is sufficiently insulated to prevent contact.

Do not strike the glass with hard or pointed items.

Do not use the product if the glass is chipped or damaged.

Do not sit or stand upon horizontal glass surfaces.

Do not use washing powders or other substances containing abrasives when cleaning the glass.

### **À ne pas faire**

Ne serrez pas trop fort aucun des éléments de cet assemblage.

Ne placez aucun objet froid ou chaud sur ou à proximité de toute surface en verre à moins que celui-ci ne présente une isolation suffisante pour empêcher tout contact.

Ne frappez pas les surfaces en verre avec des objets lourds ou pointus.

N'utilisez pas le produit si le verre est ébréché ou endommagé.

Ne vous asseyez ni ne montez pas sur les surfaces horizontales en verre.

N'utilisez pas de poudre à récurer ou toute autre substance abrasive lorsque vous nettoierez les surfaces en verre car cela risquerait de provoquer des rayures.

### **No haga**

No apriete demasiado ninguna de las piezas de este soporte.

No coloque objetos calientes o fríos en o cerca de cualquier superficie de vidrio, a menos que el objeto esté aislado para prevenir contacto directo.

No golpee el vidrio con artículos fuertes o punzantes.

No usar el producto si el cristal está astillado o dañado.

No se sienta o se pare en superficies de vidrio.

No use detergentes para lavar u otras sustancias que contengan abrasivos cuando esté limpiando el vidrio ya que estas pueden rayarlo.

### **Do's**

Do use a damp cloth with diluted washing up liquid for cleaning the glass surfaces.

Check all nuts and bolts from time to time.

### **À faire**

Utilisez un chiffon humide imprégné de liquide vaisselle dilué pour le nettoyage des surfaces en verre.

Vérifiez tous les écrous et les boulons de temps à autre.

### **Si haga**

Use un trapo suave con líquido diluido en agua para limpiar las superficies de vidrio.

Compruebe todos los tornillos y tuercas de vez en cuando.

### **Maximum TV weight and shelf capacities**

**Poids maximal du téléviseur et capacité de charge de l'étagère**

**Máximo peso y capacidad del estante de TV**

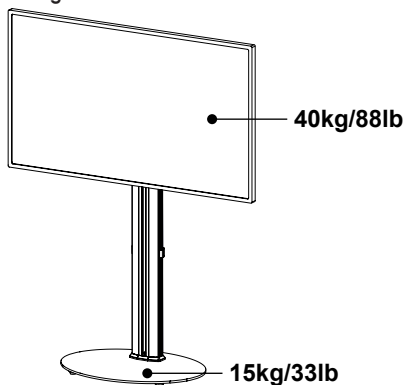

**WARNING:** Wherever possible distribute weight evenly.

**AVERTISSEMENT:** Répartissez le poids de manière uniforme lorsque cela est possible.

**ADVERTENCIA:** En la medida de lo posible distribuya el peso uniformemente.

Tools Recommended  
*Outils recommandés*  
Herramientas recomendadas

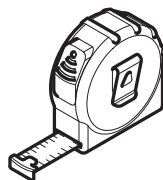
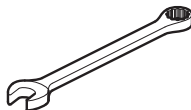
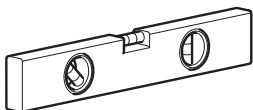

Boxed Parts  
*Pièces empaquetées*  
Piezas en la Caja

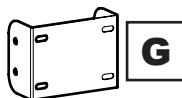
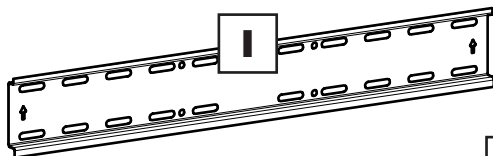
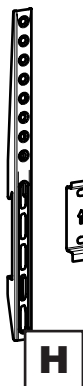

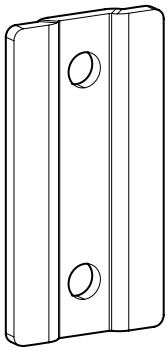

**J2** x2



**J3** x4



**J4** x12



**J5** x1

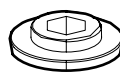

**J6** x4



**J7** x4



M6

**J8** x6

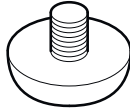

**J9** x4

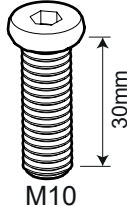

M10

**J10** x1

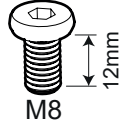

M8

**J11** x4

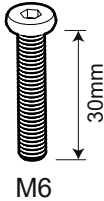

M6

**J12** x2

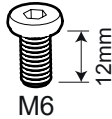

M6

**J13** x7



4mm

**K1** x1

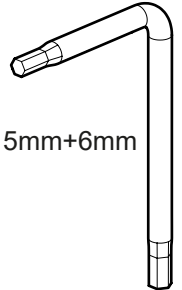

5mm+6mm

**K2** x1

TV Screws, Reducers and Spacers  
Vis TV, réducteurs et séparateurs  
Tornillos, Reductores y Espaciadores para TV



**RE1** x4



**RE2** x4



**SP1** x4



M4

**TV1** x4

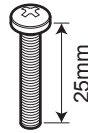

M4

**TV2** x4

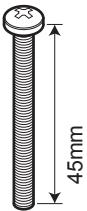

M4

**TV3** x4

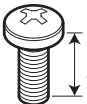

M6

**TV4** x4

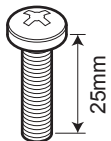

M6

**TV5** x4

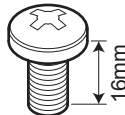

M8

**TV6** x4

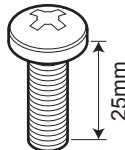

M8

**TV7** x4

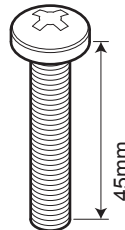

M8

**TV8** x4

**1**

Measure the TV fixing holes Width and Height  
 Mesurer la profondeur et la taille des trous de fixation  
 Mida los orificios de su TV, lo ancho y lo alto

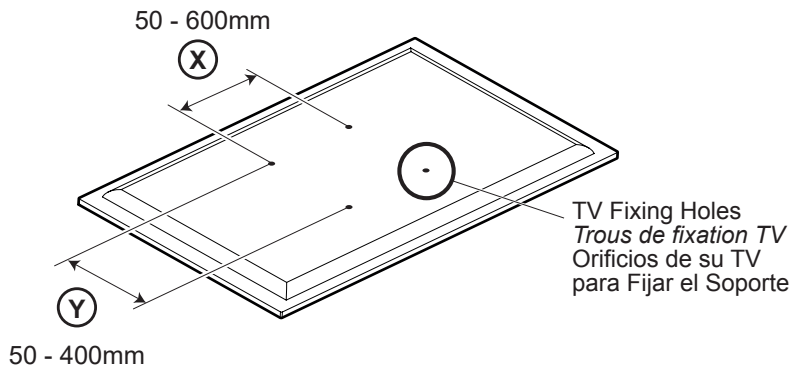

If width **(X)** is greater than 600mm or height **(Y)** greater than 400mm  
 STOP installation now and contact the customer help line  
*Si la largeur **(X)** est plus large que 600mm et la hauteur **(Y)** plus grande que 400mm,*  
*ARRÊTEZ l'installation immédiatement et contactez l'assistance client*  
 Si la anchura **(X)** es mayor que 600mm o la altura de **(Y)** es mayor que 400mm  
 DETENGA la instalación inmediatamente y póngase en contacto con la línea de ayuda al cliente

You are provided with 3 diameters of TV fixing screws, **M4**, **M6** and **M8**.

Determine the screw diameter that fits and remember for step 2.

*3 diamètres de vis TV vous sont fournis, **M4**, **M6** et **M8**.*

*Déterminez le diamètre de la vis qui convient et mémorisez- le pour l'étape 2.*

Se le proporciona con 3 diámetros de tornillos de fijación para su TV: **M4**, **M6** y **M8**.  
 Determine el diámetro del tornillo que le quede a su TV y recuérdelo para el paso 2.

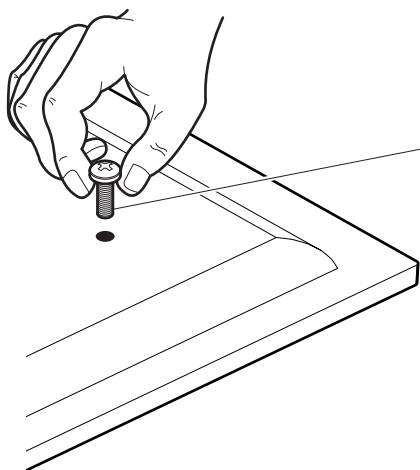

**M4 = TV<sub>1</sub>-TV<sub>3</sub>**

**M6 = TV<sub>4</sub>-TV<sub>5</sub>**

**M8 = TV<sub>6</sub>-TV<sub>8</sub>**

**2**

**Fitting the TV Brackets**  
**Montage des supports TV**  
**Fije los Brazos del Soportes a su TV**

**No Spacers**  
**Pas de séparateur**  
**Sin espaciadores**

For TVs with flat / unobstructed back  
*Pour des téléviseurs aux dos plats et non obstrués*  
 Para TVs con la parte posterior plana / sin obstáculos

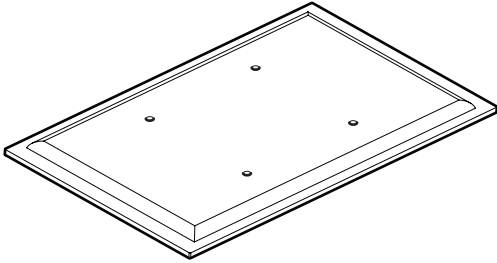

**Spacers**  
**Séparateurs**  
**Espaciadores**

**SP1**

For TVs with irregular / obstructed back  
*Pour des téléviseurs aux dos irréguliers et non obstrués*  
 Para TVs con la parte posterior irregular / con obstáculos

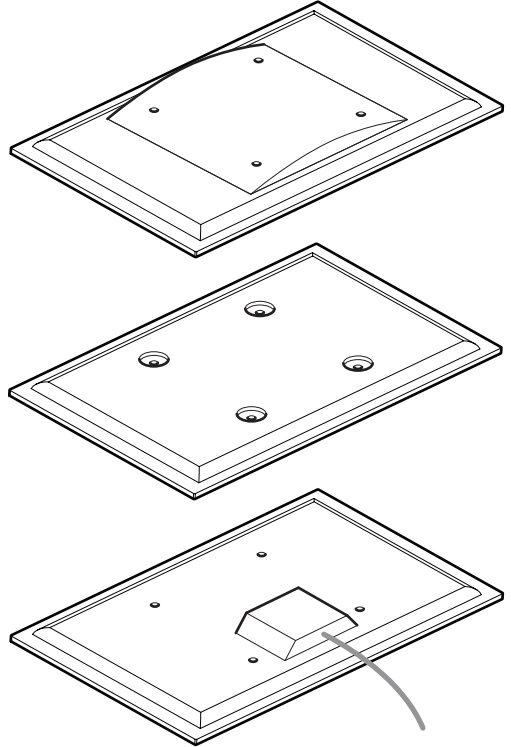

**WARNING / AVERTISSEMENT / ADVERTENCIA**

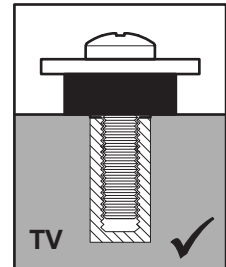
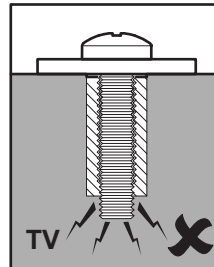
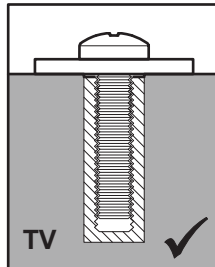
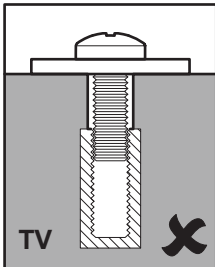

After completing step 2 you will have fittings left over, please keep for future reference.  
*Après avoir complété l'étape 2 il vous restera des pièces d'assemblage, conservez-les.*  
 Después de completar el paso 2 usted tendrá conexiones sobrantes, por favor guarde para futura referencia.

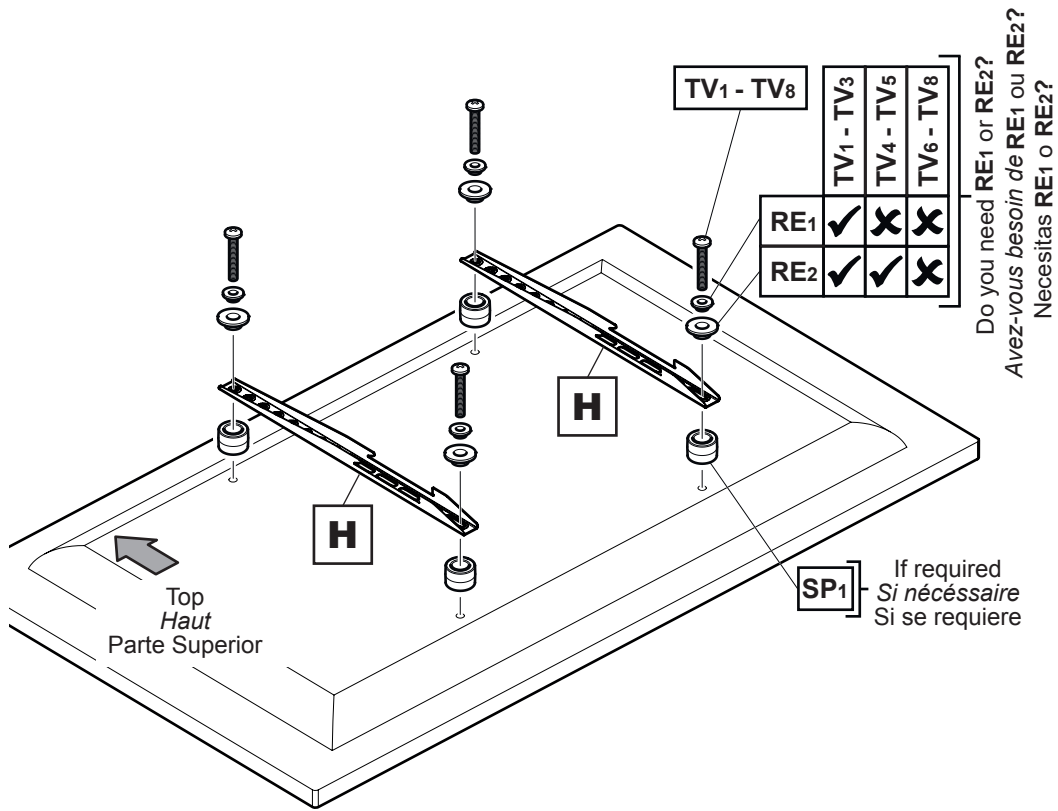

Attach the bracket to the back of your TV using suitable screw, reducer and spacer combinations.  
 Attachez l'applique au dos de votre téléviseur en utilisant une combinaison de vis, de séparateurs et de joints adaptés.

Coloque los soportes a la parte posterior de su TV usando la combinación adecuada de tornillo, reductor y espaciador.



**B**

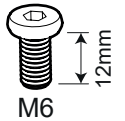
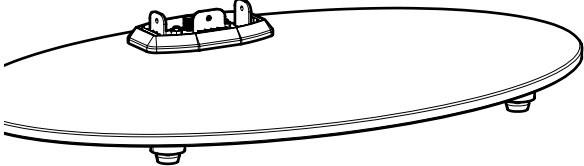
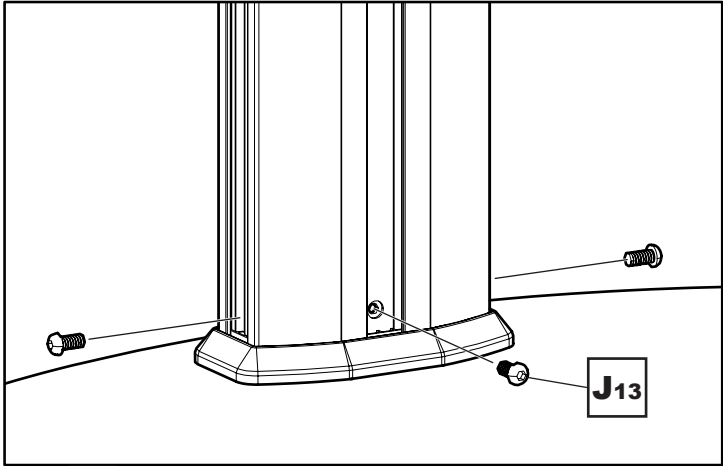

**J13** x3

5



DO NOT overtighten  
Ne serrez pas trop fort  
No apriete demasiado

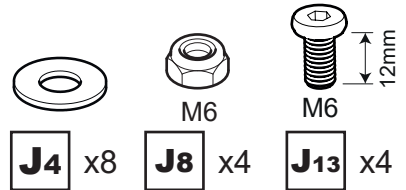
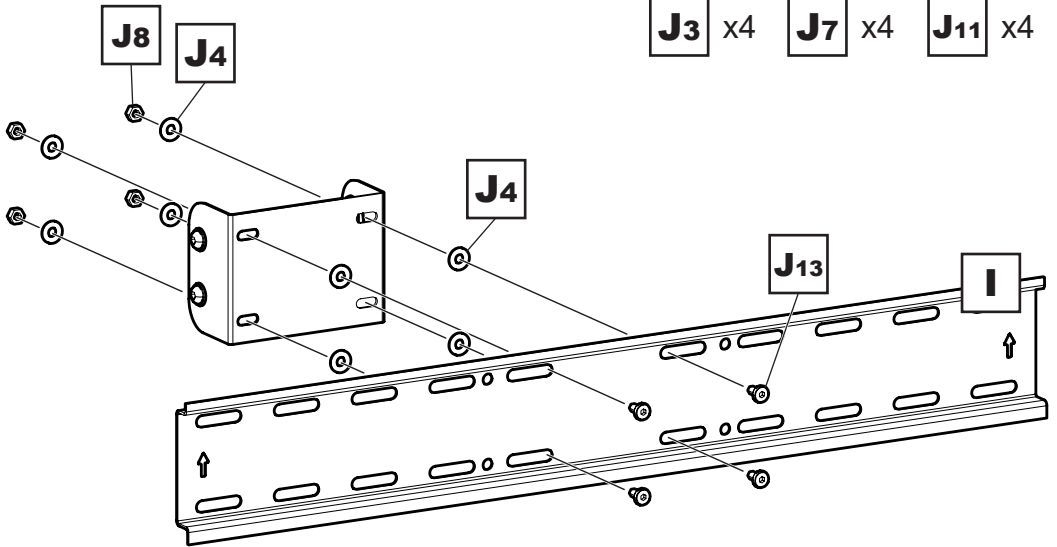
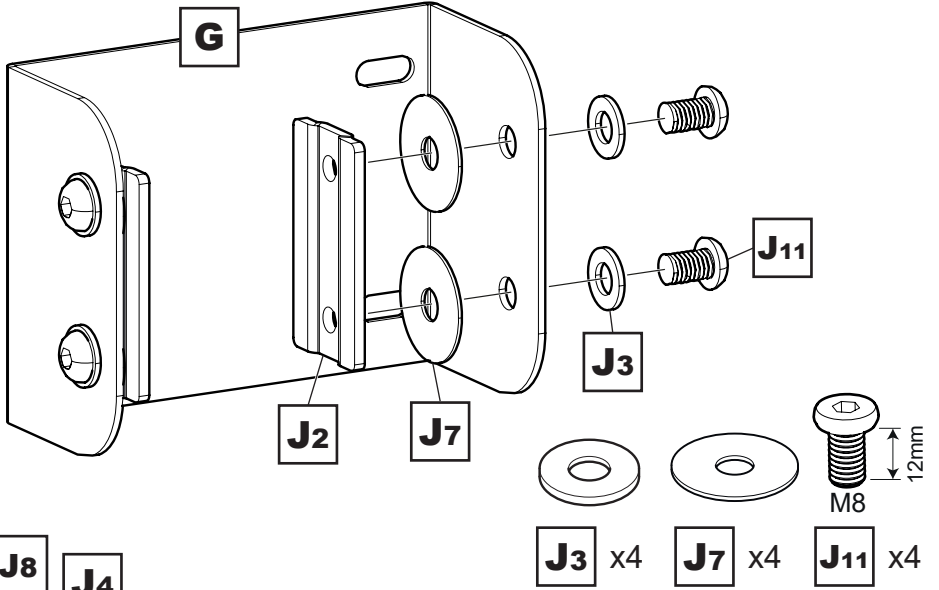
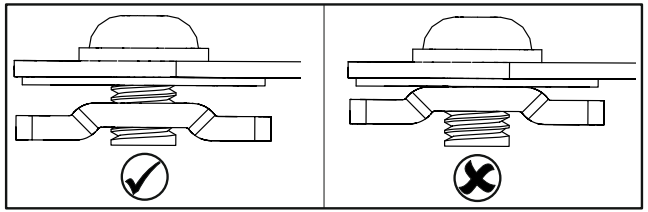



6

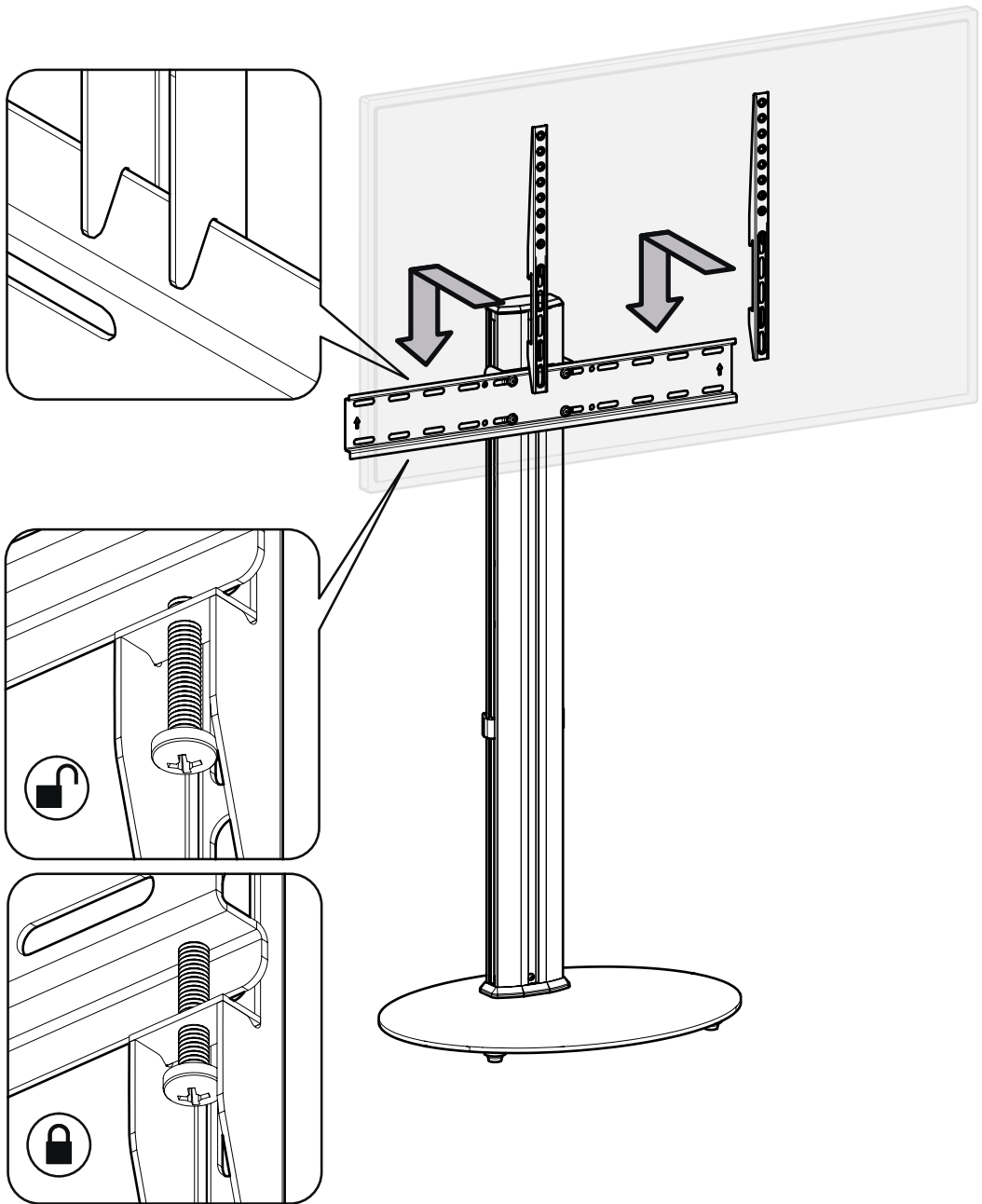

7

