







Assembly Instructions

CAUTION

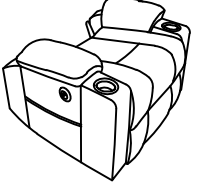
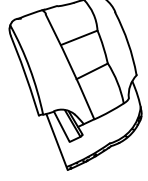
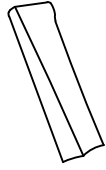
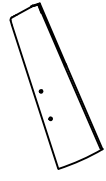
Your recliner comes packaged in one box. Carefully remove all components from the packaging and set aside for assembly.

DO NOT use any sharp objects to open plastic wrapped components as this may result damage to product or components .

Package Contents

			
A Chair Seat (x1)	B Chair Backrest (x1)	C Left Ear (x1)	D Right Ear (x1)
			
E Anti-tip bracket (x2)	F Bolts (x4)	G Butterfly Nuts (x4)	H Power Source (x1)
			
J Remote Control (x1)			

STEP 1: Attach Chair Backrest (B) to Chair Seat (A) by aligning the metal grooves on Chair Seat (A) and Chair Backrest (B). Ensure the Chair Back (B) slides down to the bottom of the Chair Seat (A)'s metal grooves.

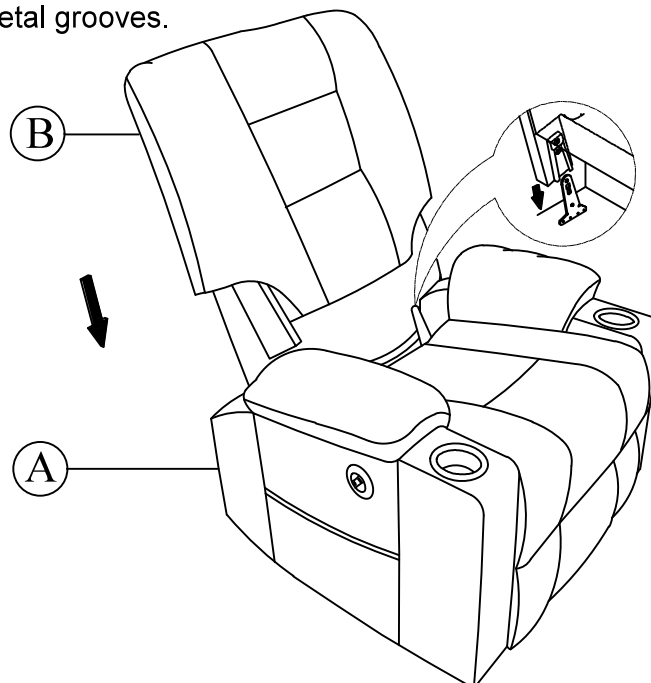

STEP 2: Attach the left ear (C) and right ear(D) to Chair Backrest (B) by aligning the metal grooves.

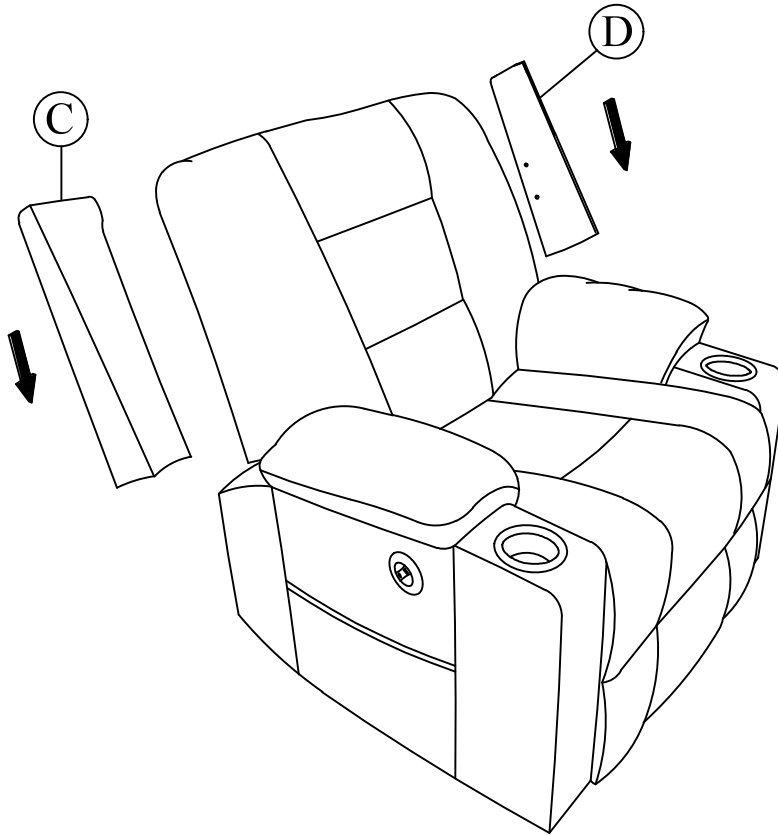

STEP 3: After completing Step 4 on the next page (electrical wiring connection), press the control switch to raise the chair before attaching the anti-tip bracket. Attach the anti-tip bracket (E) to the rear of the metal base using bolts (F) and butterfly nuts (G).

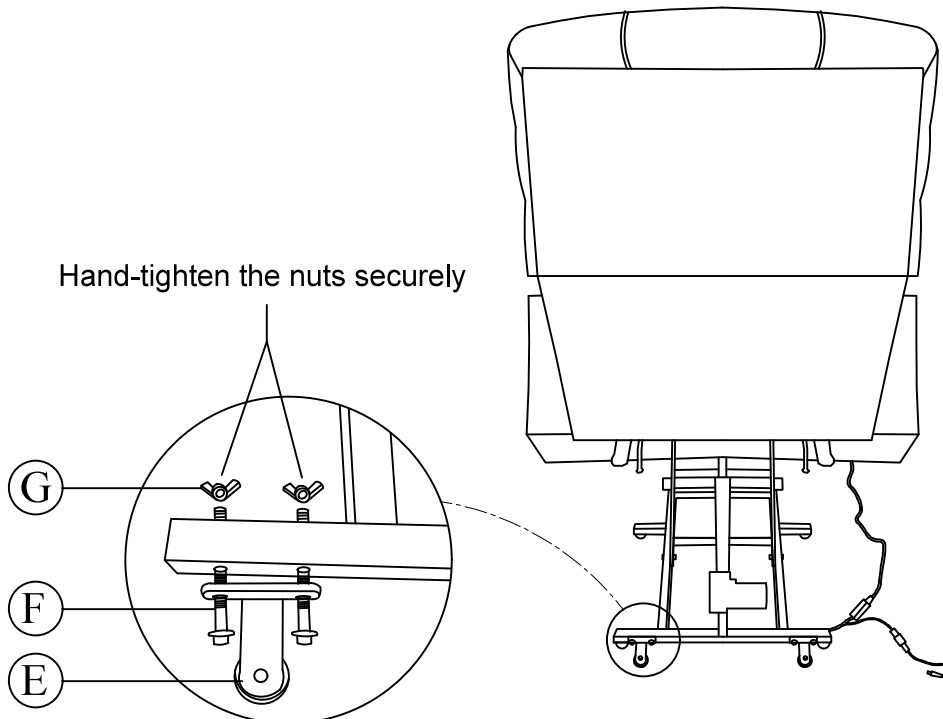

STEP 4: Connect the plug line to the switching power line: white to white, red to red.

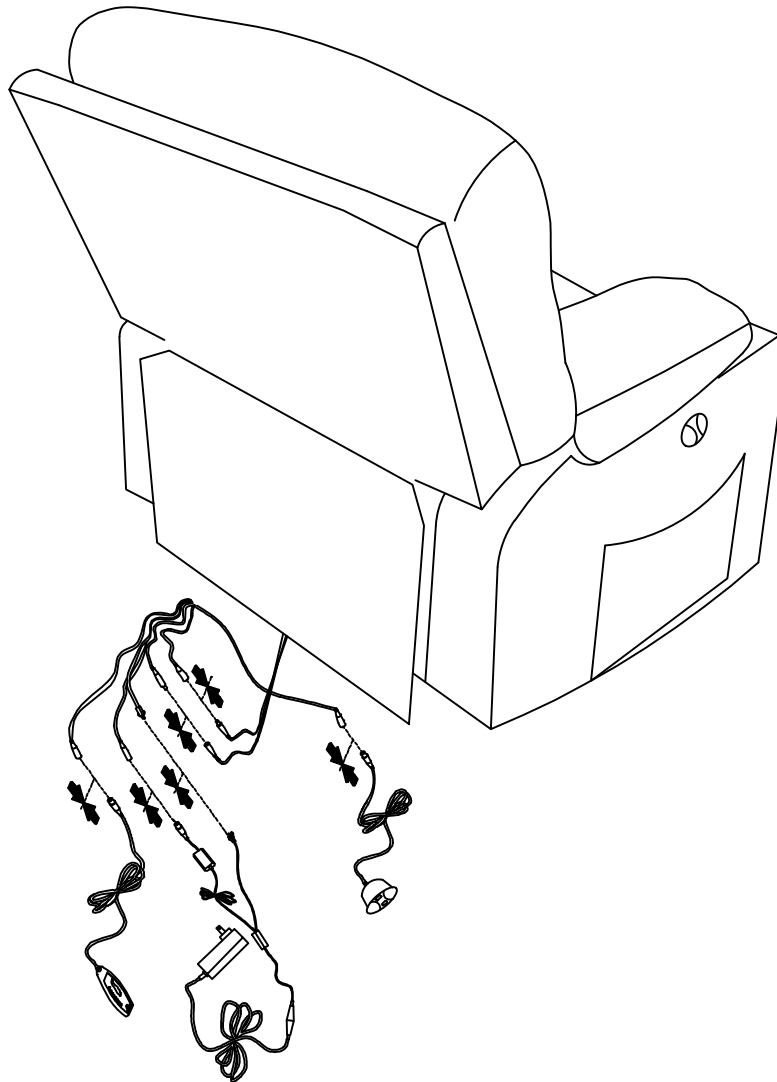

Red to Red



White to White

The connector has one corner that is square

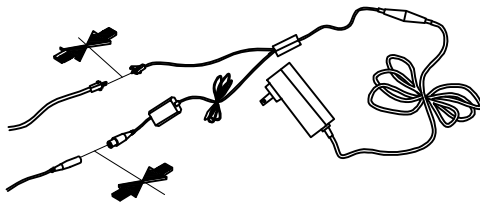

H



J

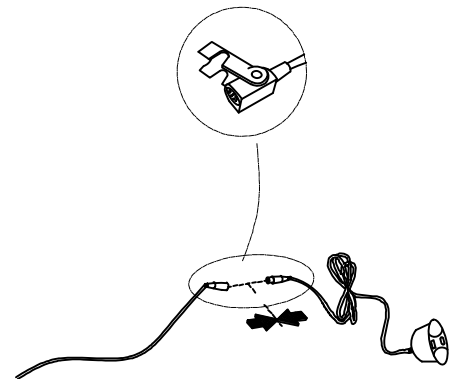

Warnings

1. Please check if the components of the chair are all included and can be used normally.
2. Assemble all components according to the instruction correctly before you connect the chair to the power.
3. Please DO NOT sit on the armrests or footrest to eliminate the risk of tipping over.
4. If the chair is damaged or doesn't match the website description, please send clear pictures of the product and label of the carton to our service team for further help.
5. If the recliner doesn't work, you may try the following measures for self-checking firstly:
 - a) Check if all the cables are connected;
 - b) Check if the light of transformer is on.

If the chair still doesn't work, please feed the information back to our customer service in time and we'll help you solve the matter as soon as possible

6. If you have any questions with the product, please contact us.

