











ASSEMBLY INSTRUCTIONS

Caution : You must read this before you proceed

| Care & Maintenance | |
|---|---|
|  | Not for commercial use. For residential use only. |
|  | Do not put hot items directly on furniture surface. |
|  | Do not clean furniture with harsh cleansers or polish. |
|  | Do not place furniture under direct sunlight. |
|  | Do not place furniture near heating or cooling vents. |
|  | Do not write on furniture without a padded barrier to protect the surface |
|  | Do not place furniture outside . For indoor use only. |
|  | Stains may be removed with mild soap solution and damp cloth. |
|  | Children should not climb or jump on the furniture. |
|  | Dust and pick-up spills using a clean, non-colored, lint-free cloth. |

SINGLE CHAIR

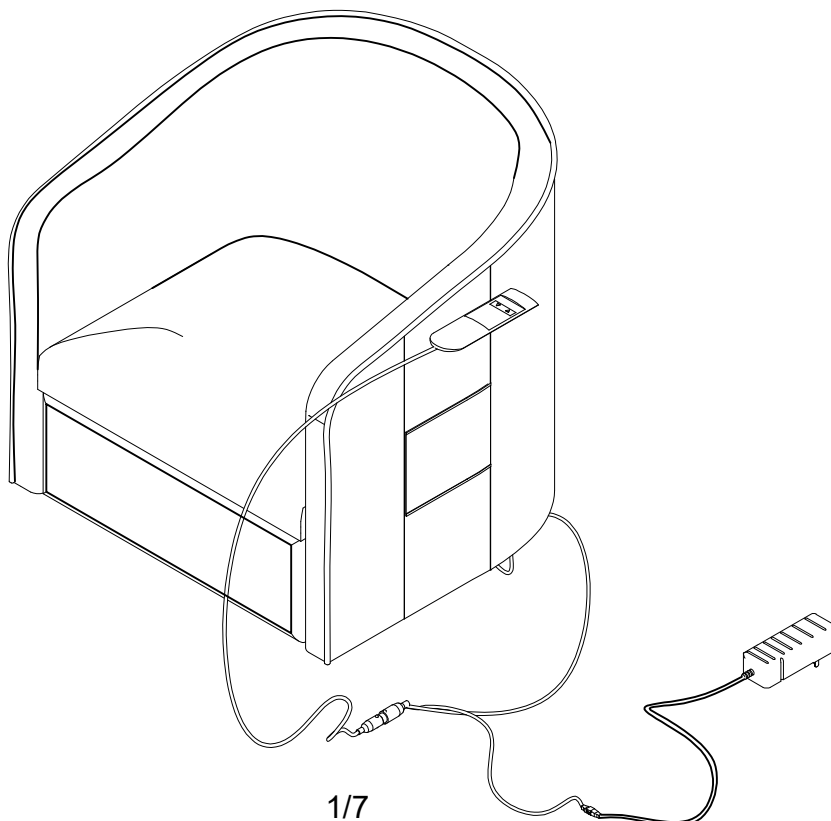

PARTS LIST:

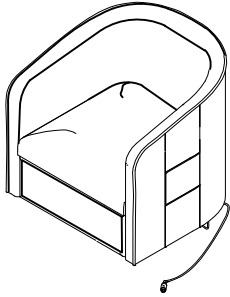
| Label | Picture | Description | QTY |
|----------|---|---------------------|----------|
| A |  | Single chair | 1 |

Hardware:

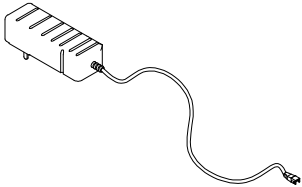
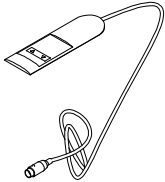
| Label | Picture | Description | QTY |
|-------|---|-----------------------|----------|
| ① |  | Charging cable | 1 |
| ② |  | Control | 1 |

Packing List

BOX 1-1

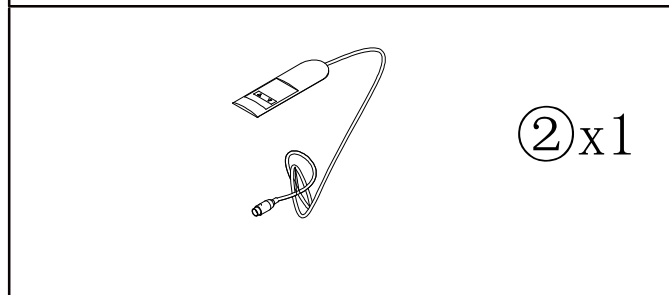
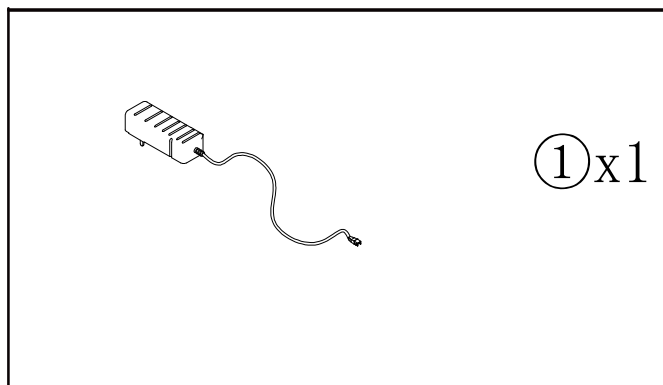
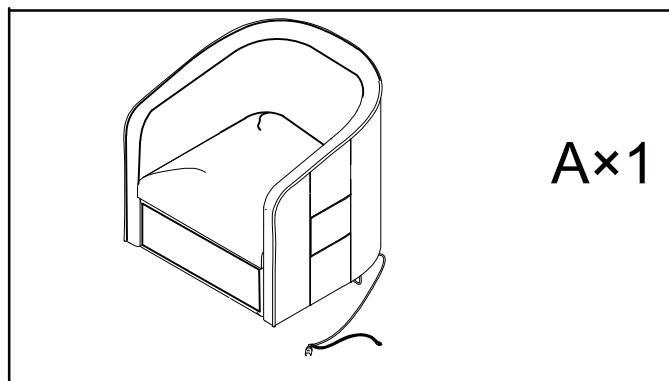

Before Beginning Assembly:

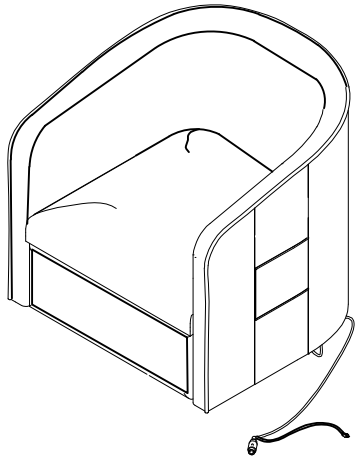

Ax1

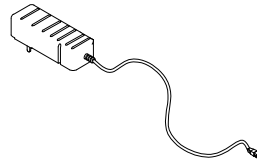

①x1

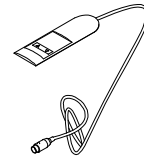

②x1



Read instructions, cover to cover-



Have 2 adults on hand for assembly-



Do not assemble on flooring or carpet-



Assemble on a clean non-marring surface (packing foam)-



Save all packaging until finished-

Assembly Steps

Overview

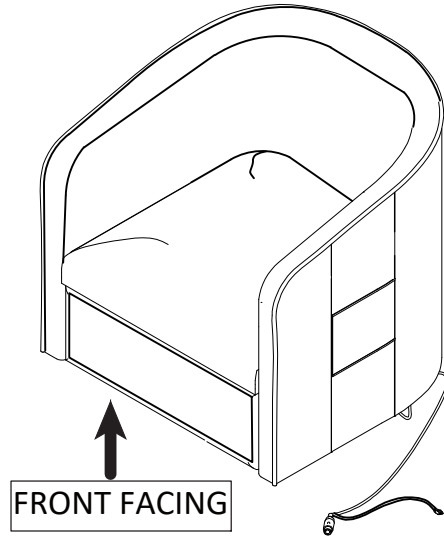

This single chair has multiple parts and may require up to 30 minutes to assemble. To give you an overview of the single chair parts, the above picture is to help you put the various parts into perspective. Please read through the instructions herebelow to familiarise the parts and steps before assembly.

Step 1:

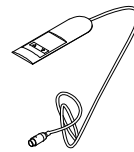
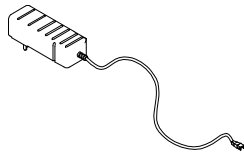
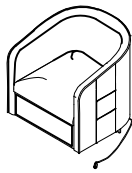

Unpack and place all parts on a clean, non-marring surface.

Step 2:

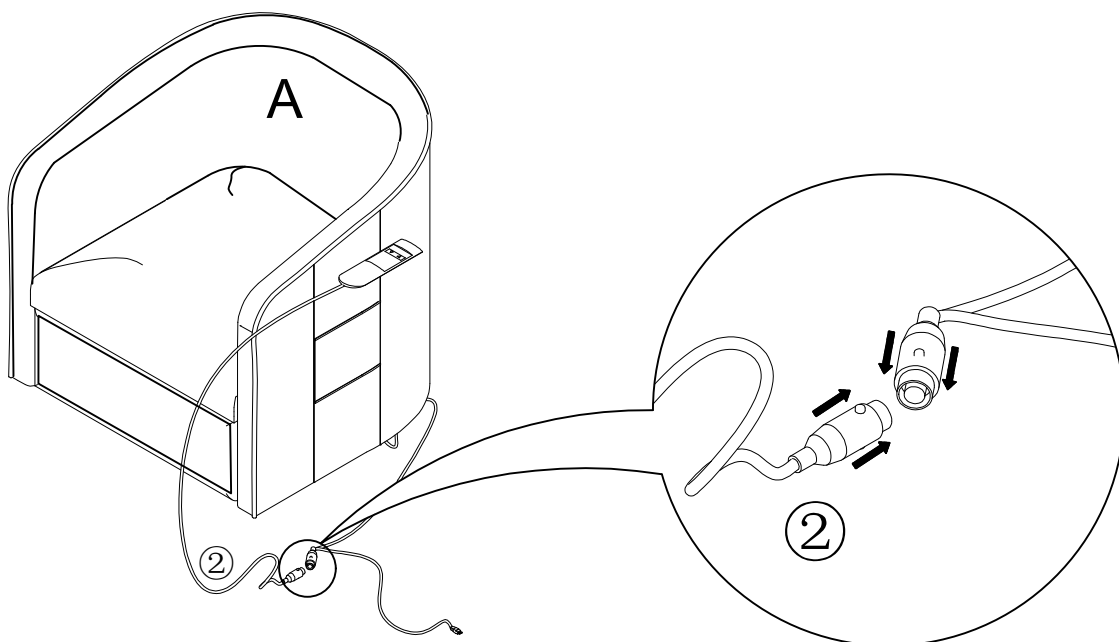

Step 3:

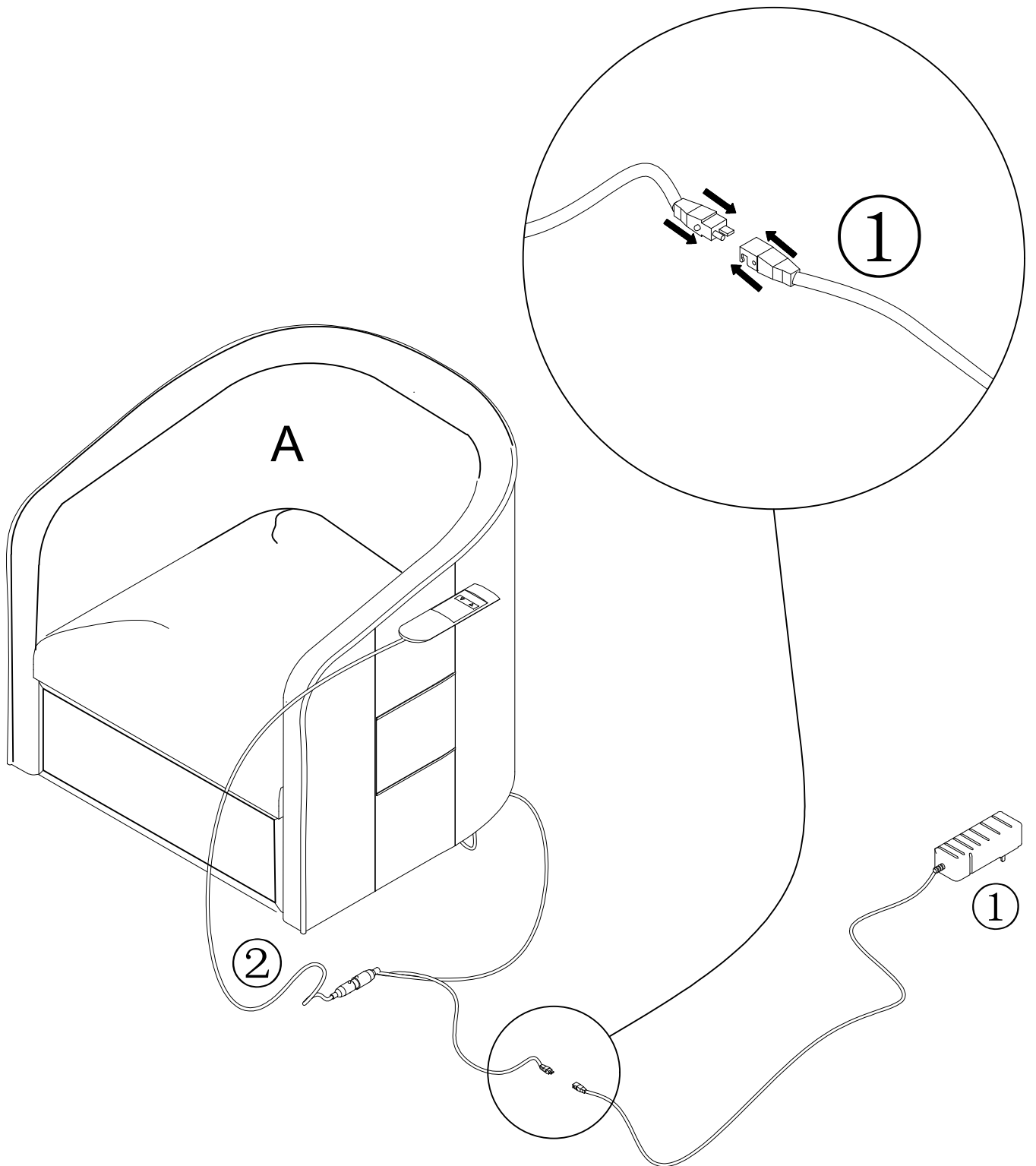

Step 4:

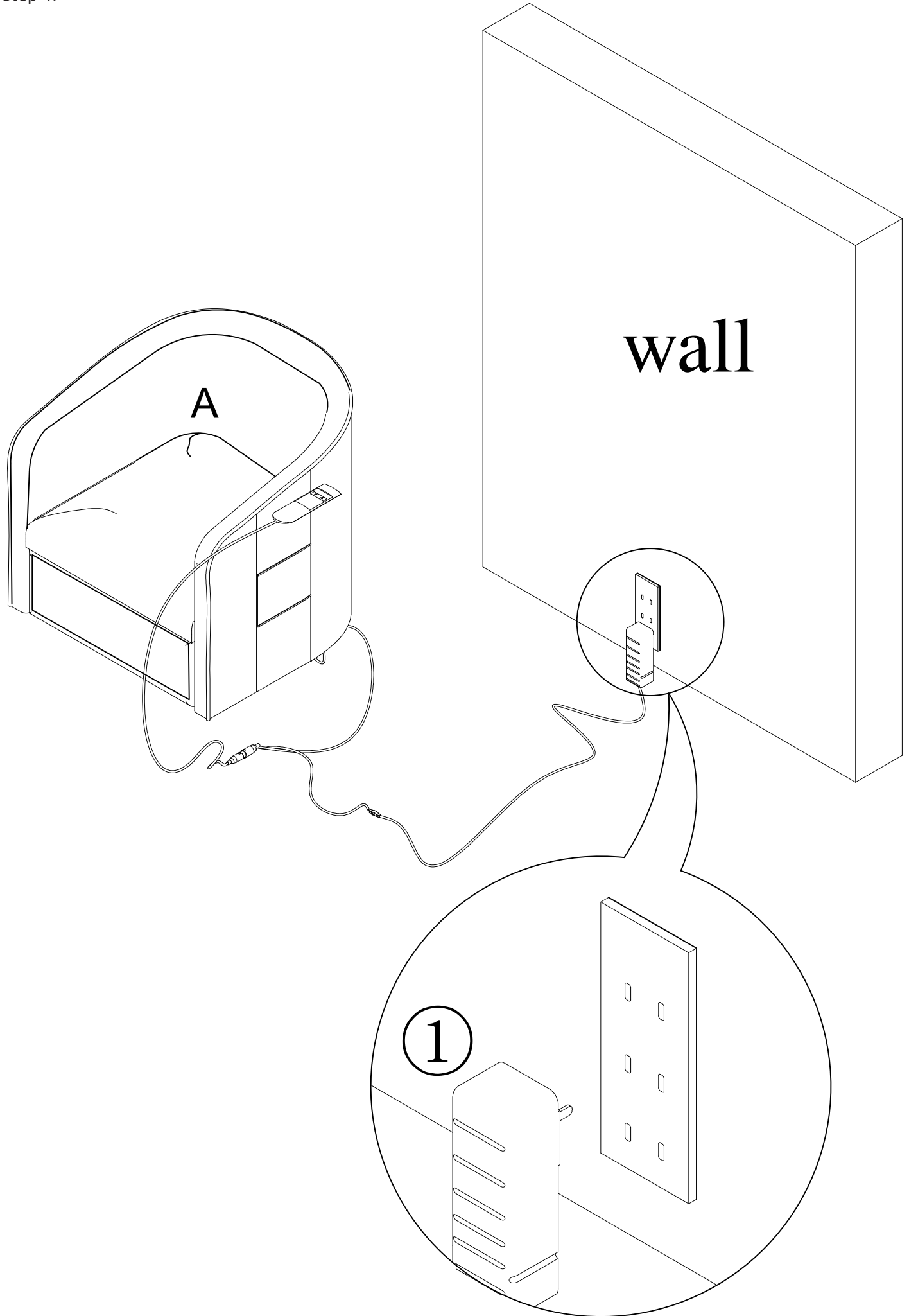

Step 5:

