

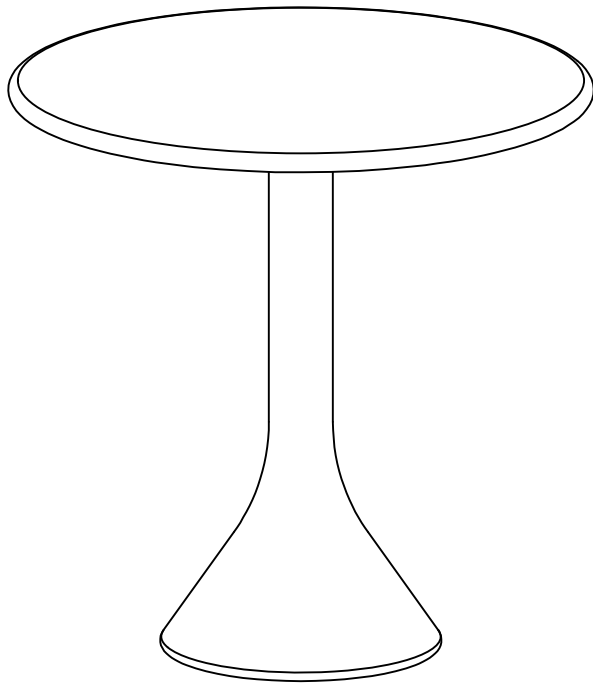



# ASSEMBLY INSTRUCTION FOR

MODEL : Vernon Bar Table - Counter



Hardware List			
No	Description	Figure	Q'TY
1	Allen key M4		1
2	Hexagon Bolt M8x15		4
3	Located Bolt M8x40		2

## Step 1

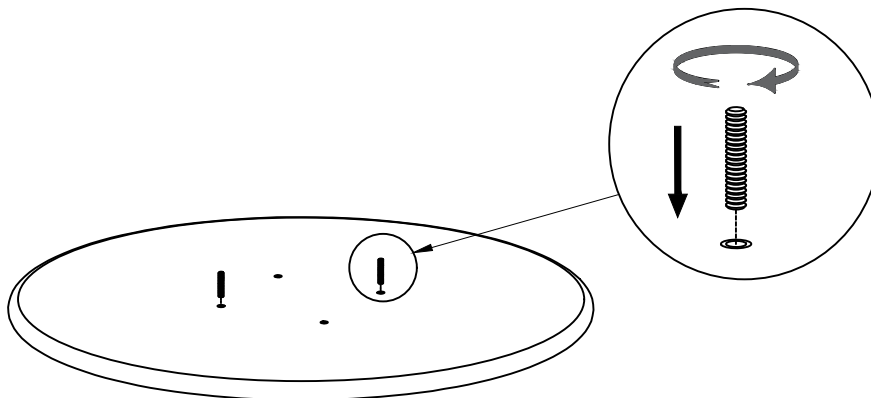

## Step 2

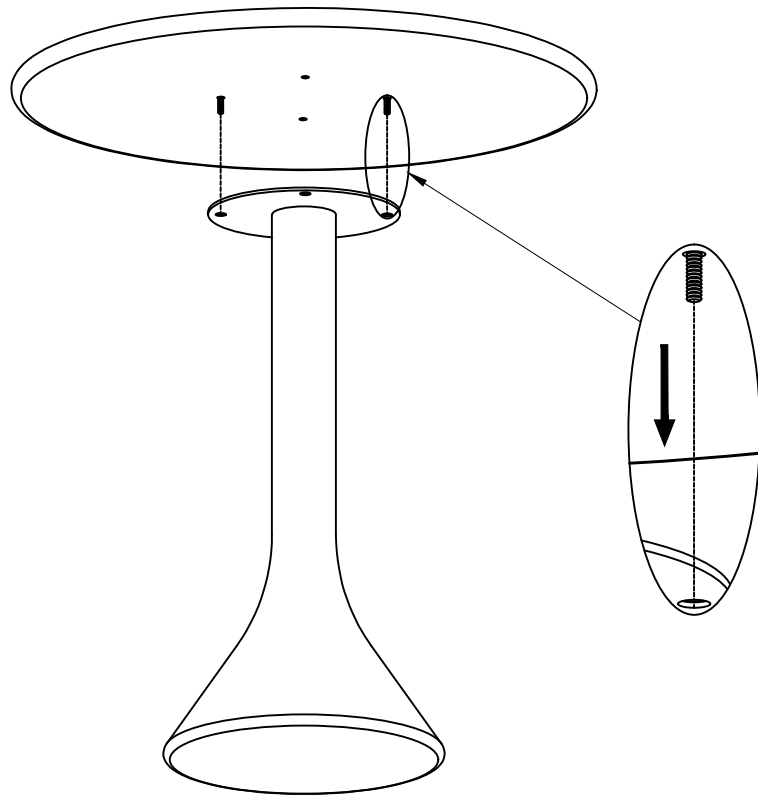

## Step 3

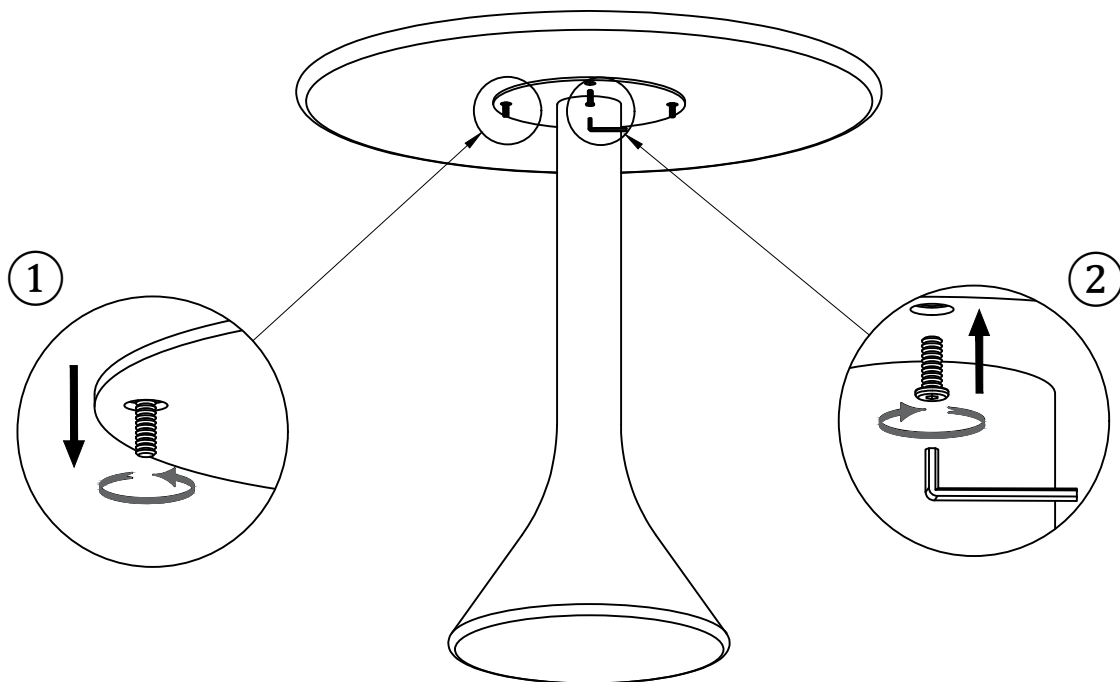

## Step 4

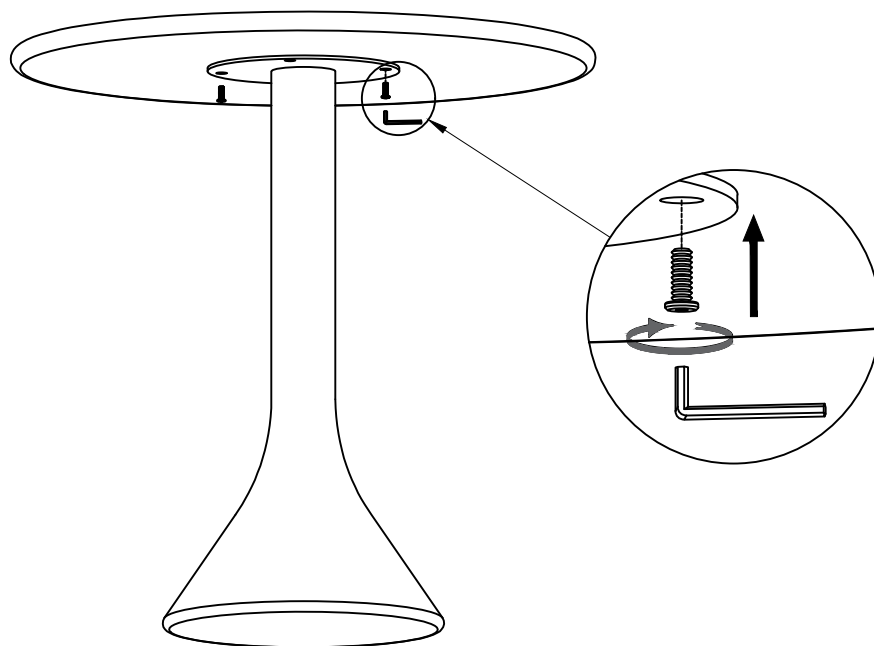

## Step 5

