



General Manual for Arched Trellis Systems

© Copyright 2024 Vego Garden Inc.



Room to grow.



Assembly Videos



Assembly Videos

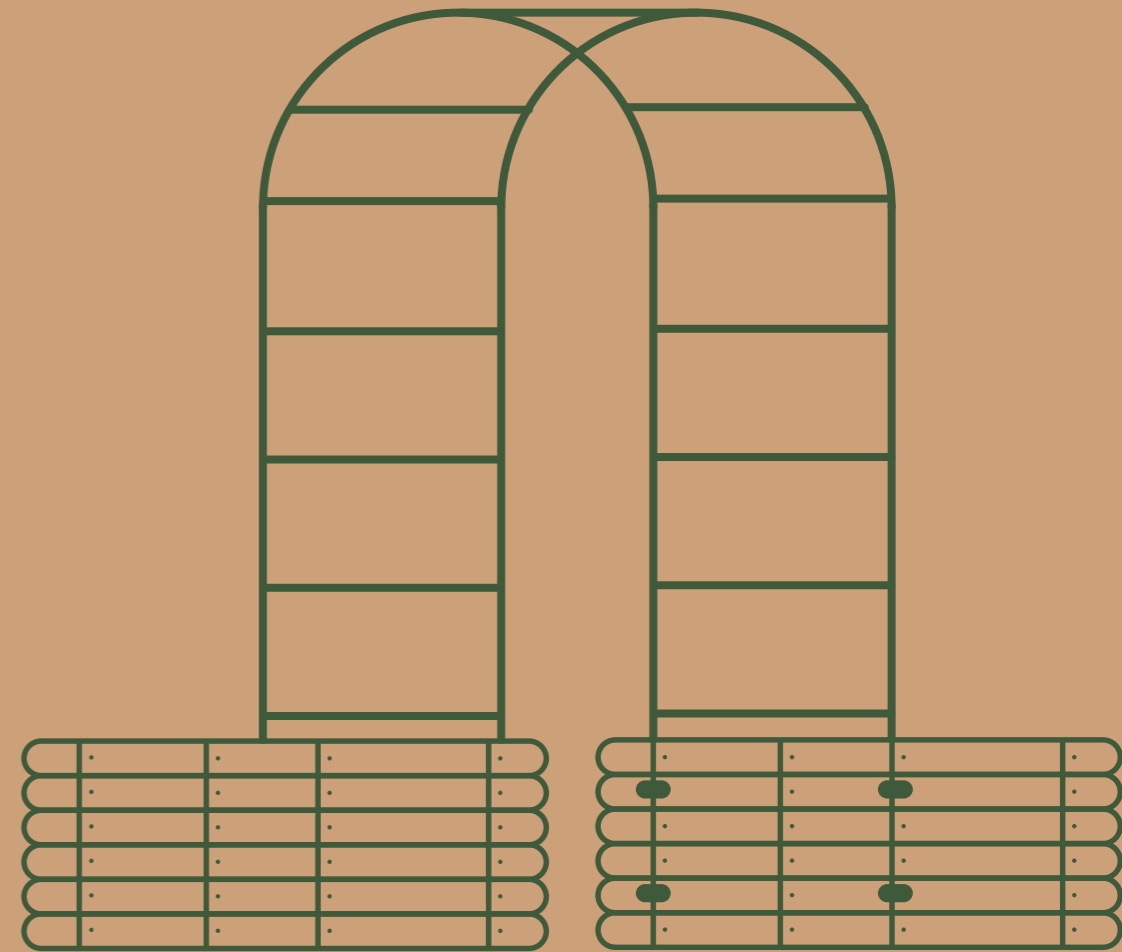

Contact Us

+1 (866) 597-1888

Vego Garden Academy

hello@vegogarden.com

vegogarden.com

vego_garden

Houston, TX

Parts List

Arch Poles

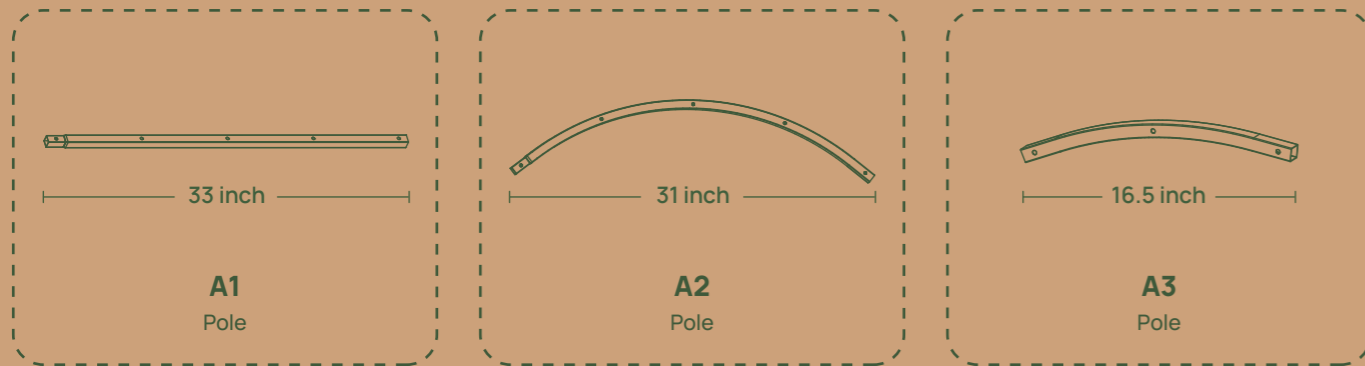

Link Poles

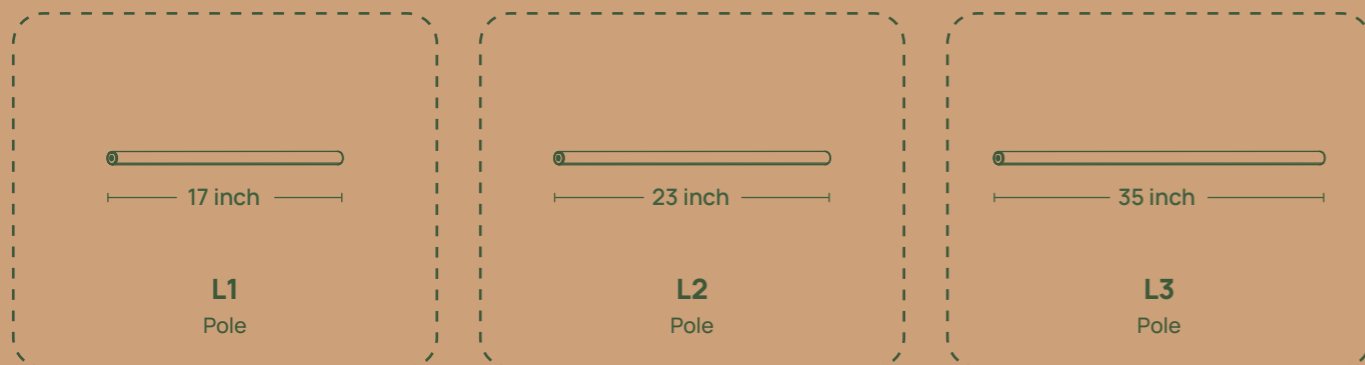

Connectors



Hardware

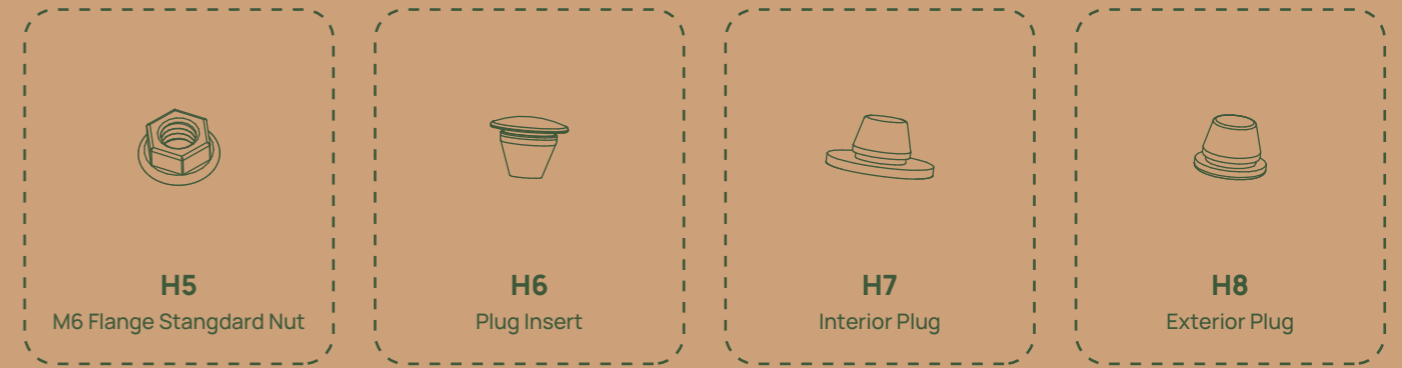
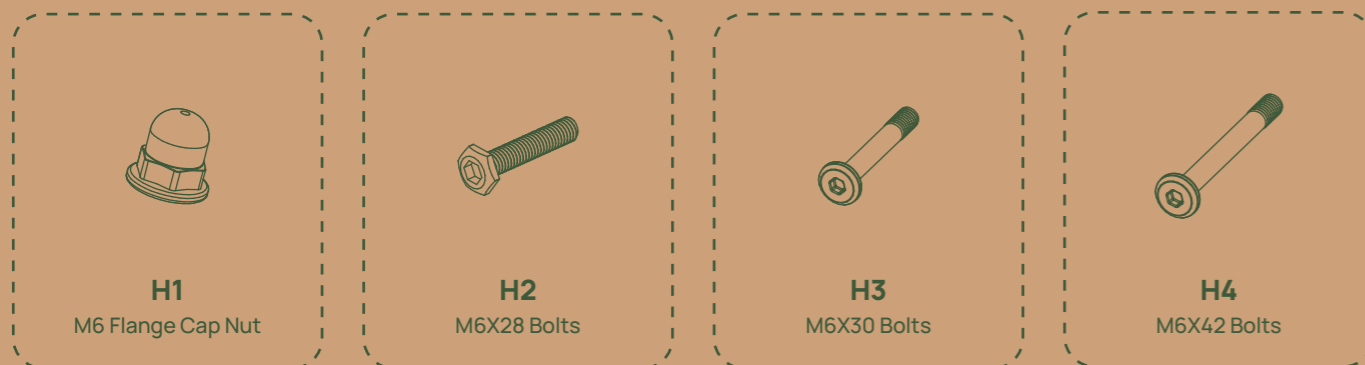



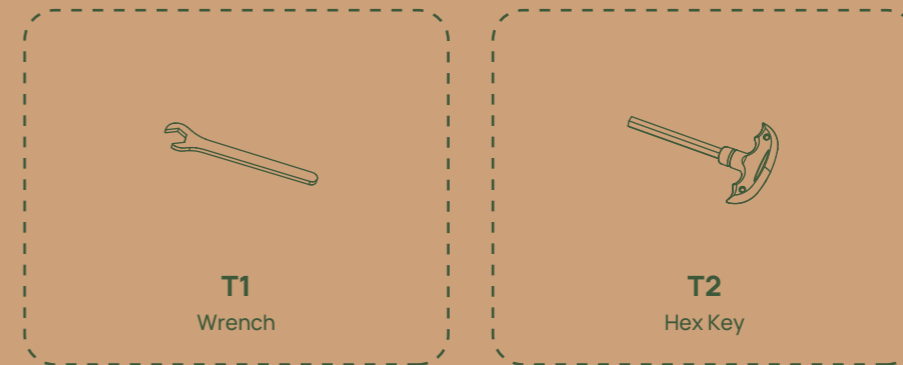

Tools



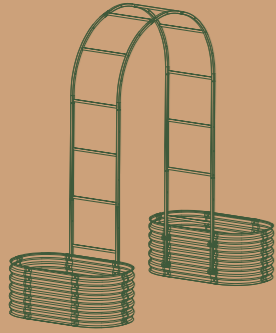
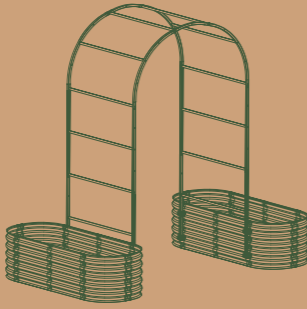

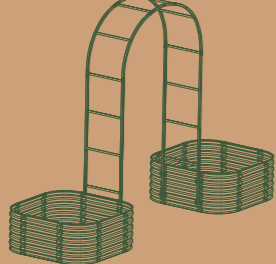
Assembly Videos

(Note: This manual is designed for all Vego Garden Arched Trellis, and the variety of parts & quantity will vary depending on the model that was purchased.)

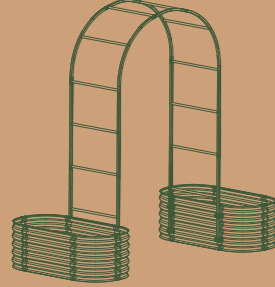
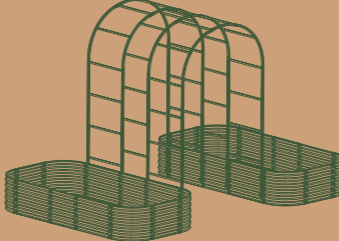
<p>VAT15</p>  <p>2.0ft x 3.5ft</p>	<p>VAT30</p>  <p>2.0ft x 5.0ft</p>	<p>VAT45</p>  <p>2.0ft x 6.5ft</p>
 <p>3.5ft x 3.5ft</p>	 <p>3.5ft x 5.0ft</p>	 <p>3.5ft x 6.5ft</p>

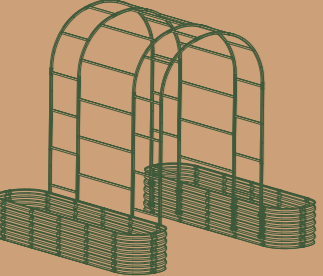
<p>VAT20</p>  <p>2.0ft x 4.0ft</p>	<p>VAT55</p>  <p>4.0ft x 8.0ft</p>
--	---

<p>VAT60</p>  <p>2.0ft x 8.0ft</p>	<p>VAT70</p>  <p>2.5ft x 9.5ft</p>
--	---

1 Step 1: Prepare Your Space

Garden beds should be placed parallel and 4.5ft apart.

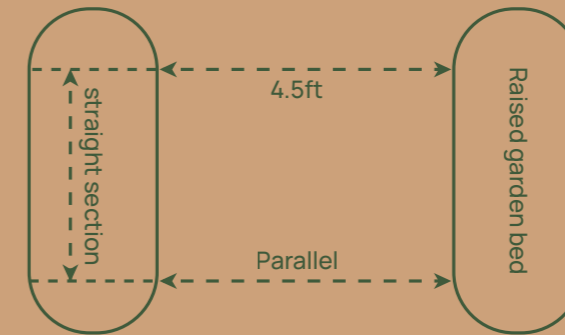

2 Step 2: Attach Connectors (P1/P2)

First, identify the Upper Connectors, which have a notched cut out, and the Lower Connectors which have a smooth cut out. The Upper Connectors attach to the **2nd** bolt holes from the top of your garden bed, while the Lower Connectors attach to the **5th** bolt holes of your 17" garden bed. Insert an **H2** bolt through the connector and garden bed as shown. Secure the connectors through these holes using H2 bolts, washers, & nuts. We recommended using bolt holes **#2** and **#4** for Connector installation on **32"** models & bolt holes **#1** and **#3** for Connector installation on **11"** models.

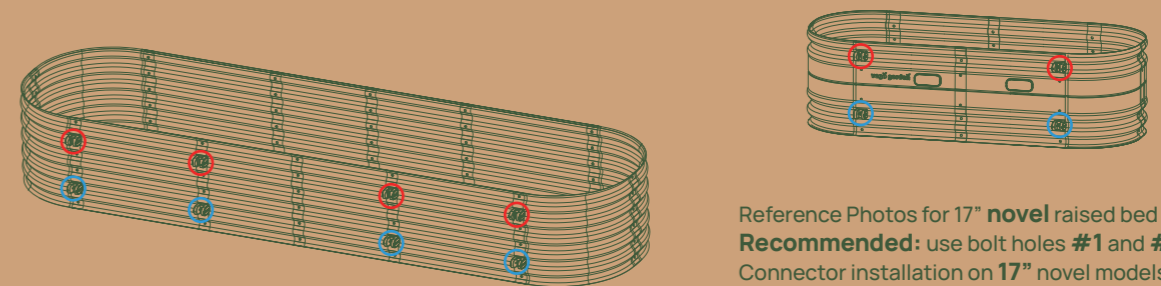
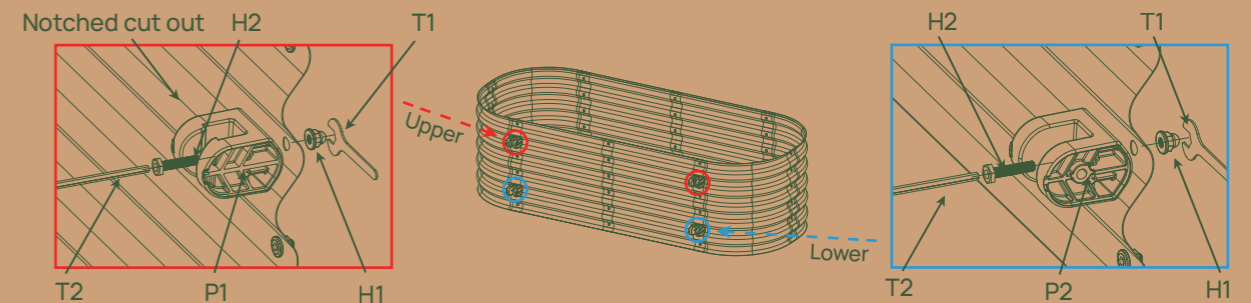

Reference Photos for 17" novel raised bed models. **Recommended:** use bolt holes **#1** and **#4** for Connector installation on **17"** novel models, use bolt holes **#1** and **#5** for Connector installation on **32"** novel models

3 Step 3: Attach Arch Poles (A1) to Connectors

Once the Connectors are secured to the garden bed, slide the longest Square Poles (A1) into the Connectors with the **flat end down**, and the **notched end up**. Secure the Square Poles (A1) by inserting H4 bolts through the Lower Connectors, and attach cap nuts.

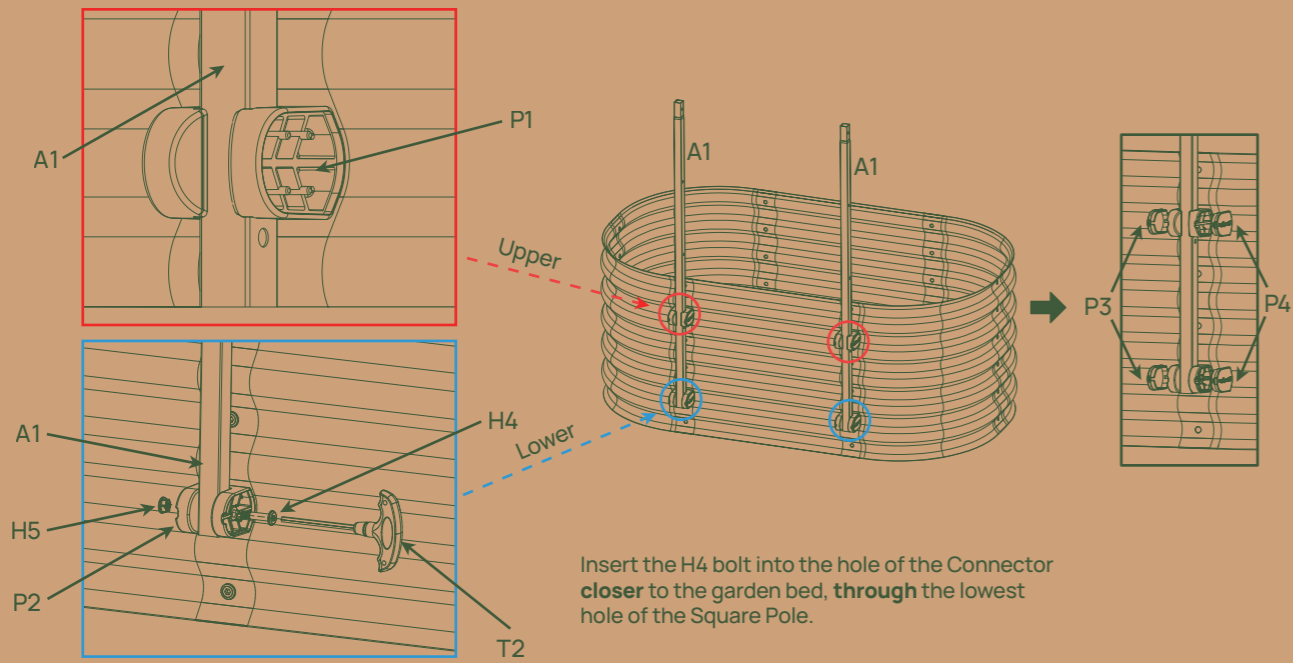

4 Step 4: Install remaining Arch Poles

Connect **additional** Arch Poles (A1,A2,A3) into vertical sections, making sure to align the pre-drilled holes in the overlapping sections.

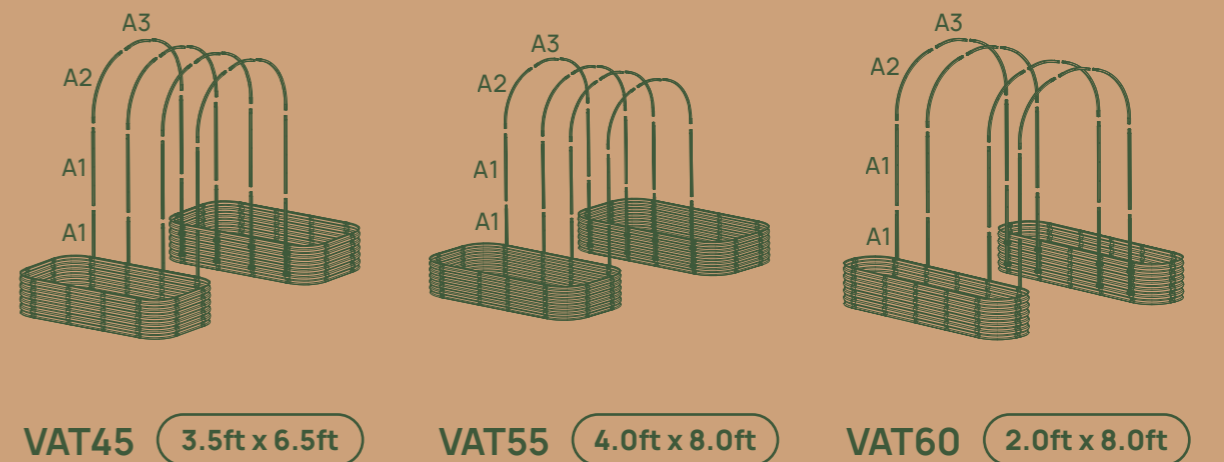
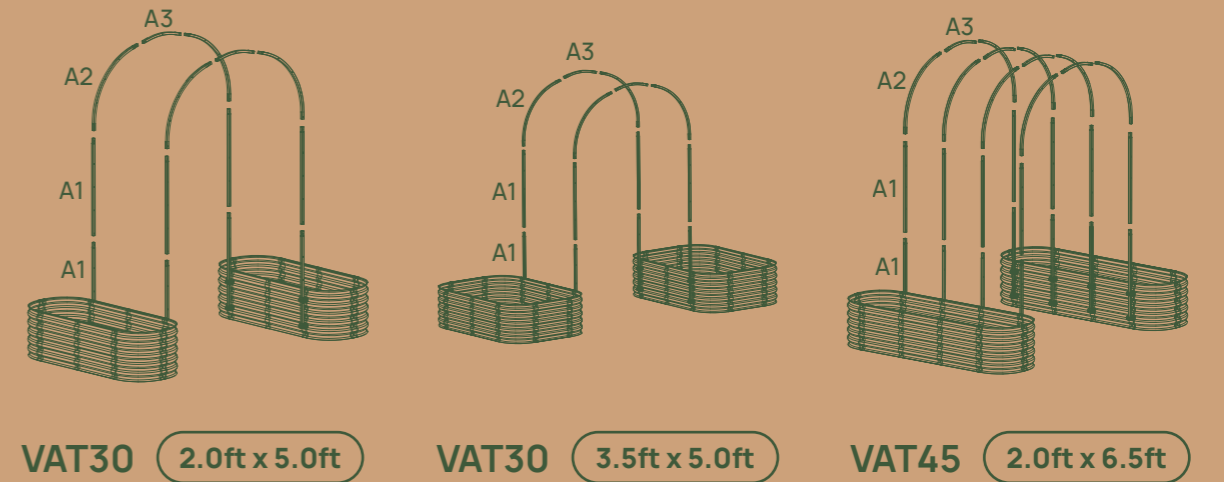
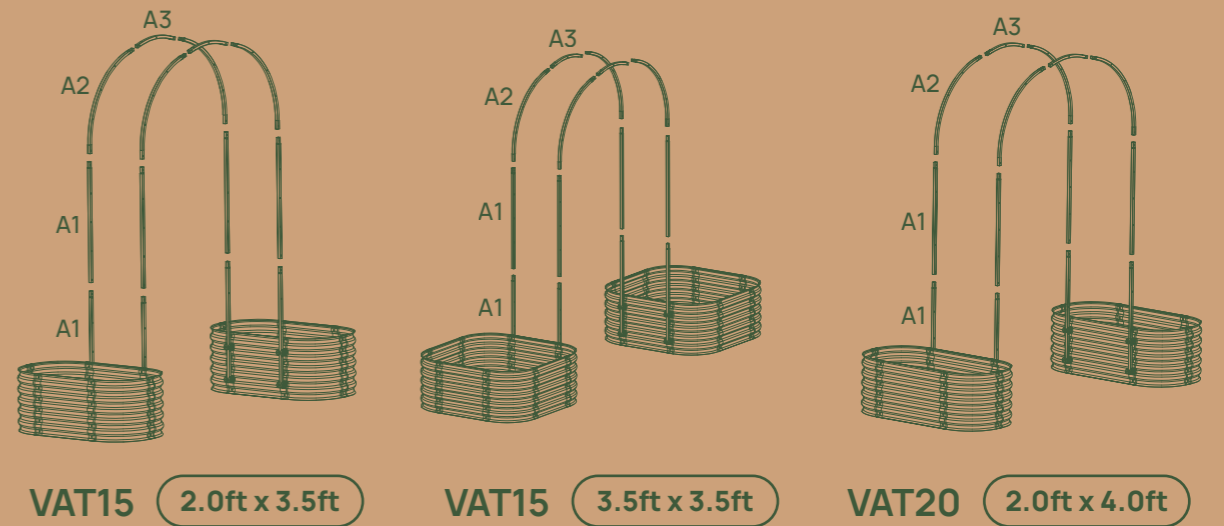
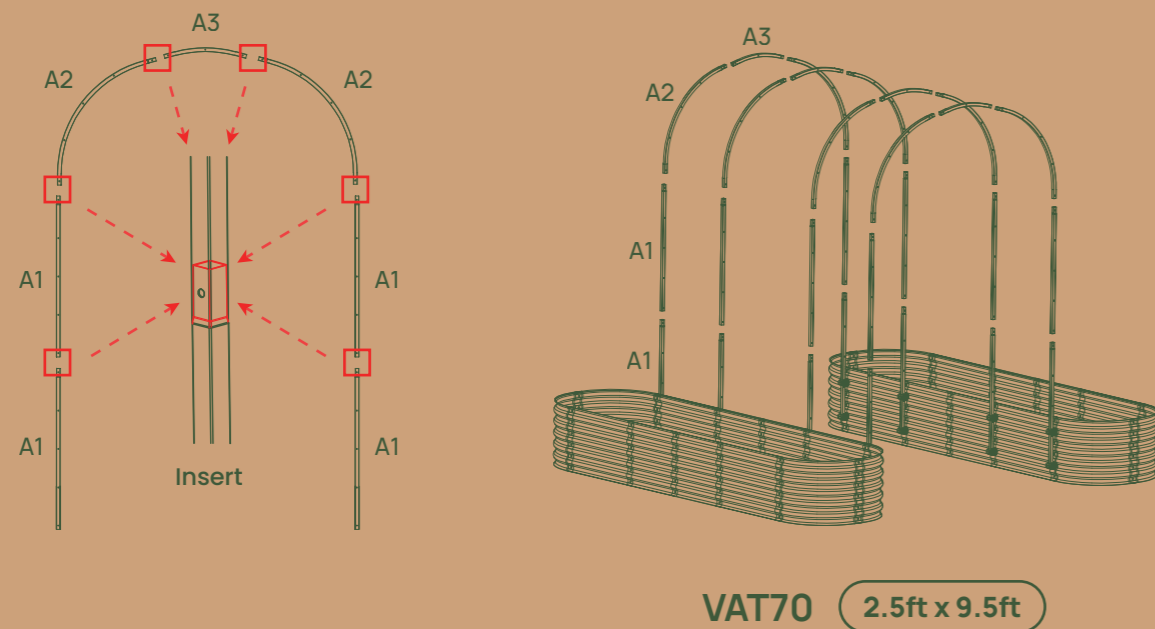

5 Step 5: Connect the Arch Frames with Link Poles (L1,L2,L3)

Connect the Arch Frames with Link Poles first **in the places where the Arch Frame pieces overlap**. Place an H8 Exterior Plug into the hole on the side that the bolt will insert into, and an H7 Interior Plug into the hole where the Link Pole will be connected. Insert an H3 bolt through the plus, hole, and pole, securing the bolt with the T2 Hex Key, seen below in **RED**.

Add Link Poles **in the middle holes between the existing Link Poles**, seen below in **BLUE**.

Connect the Arch Frames with Reinforcing Link Poles (L1,L2,L3)

Add Link Poles **in the remaining holes between the existing Link Poles**. (This step only applies to models **VAT45, VAT55, VAT60, VAT70,**) seen below in **WHITE**.

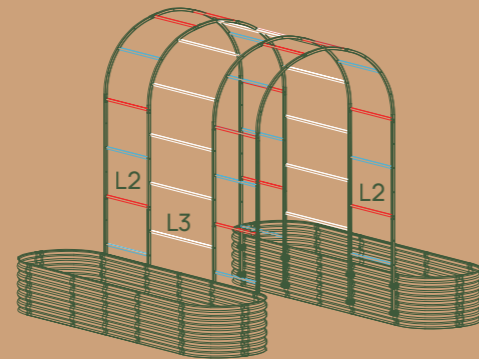
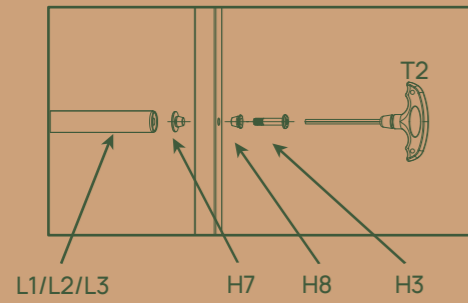

VAT70 2.5ft x 9.5ft

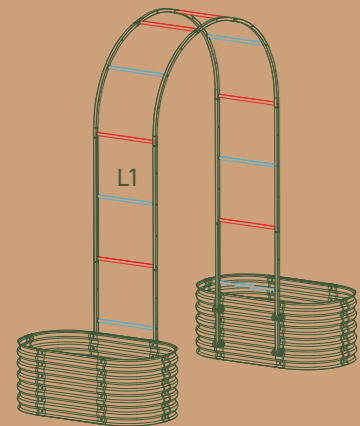

VAT15 2.0ft x 3.5ft

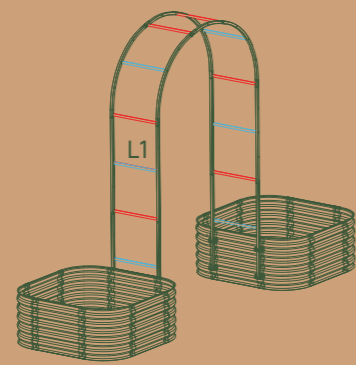

VAT15 3.5ft x 3.5ft

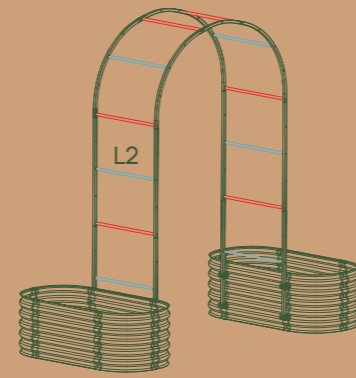

VAT20 2.0ft x 4.0ft

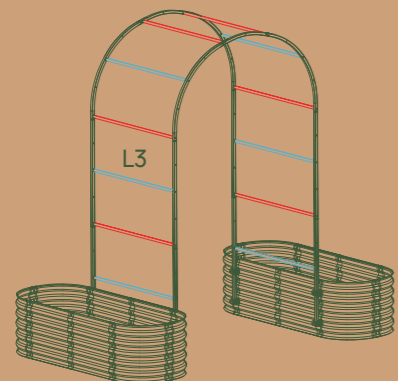

VAT30 2.0ft x 5.0ft

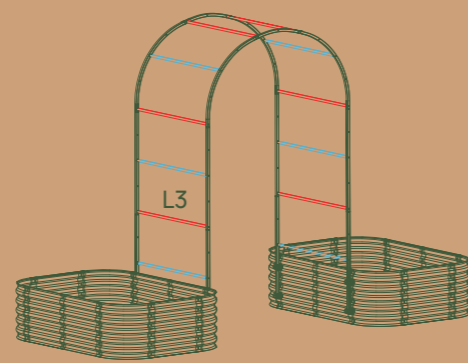

VAT30 3.5ft x 5.0ft

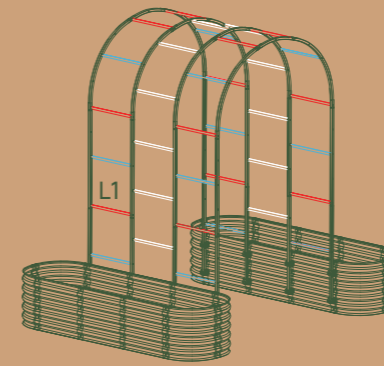

VAT45 2.0ft x 6.5ft

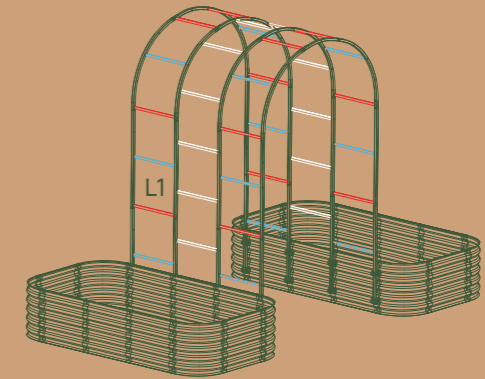

VAT45 3.5ft x 6.5ft

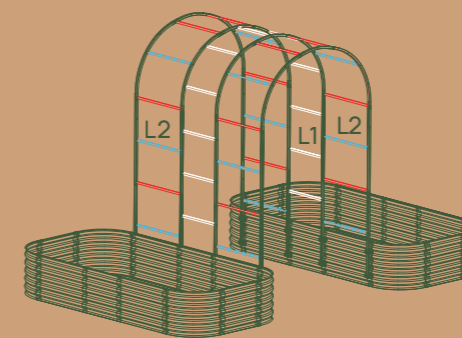

VAT55 4.0ft x 8.0ft

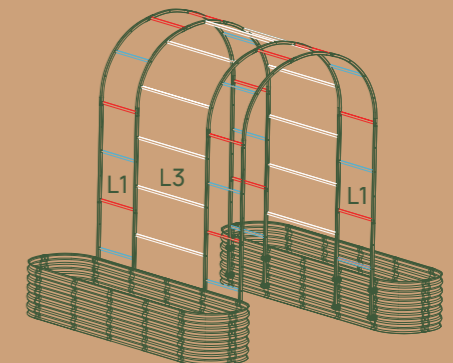

VAT60 2.0ft x 8.0ft

6 Step 6: Plug Remaining Holes

Fill remaining empty holes with Plug Inserts (H6)
Trellis is complete!

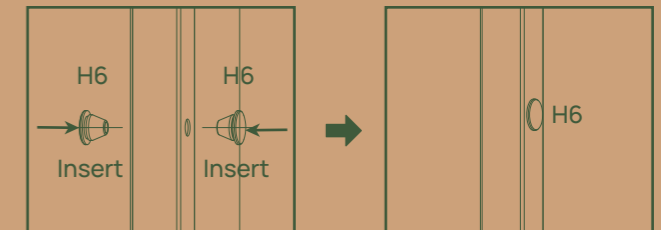

Tip

If desired, hemp ropes can be tied to the trellis to help vines climb. Hemp rope is not included, but recommended as it can be naturally composted once used.

