

Let's build the SKU **GT037**

No heartburn, when we handle the return

Shoot us a message at service@giluta.com
we will issue you a free replacement with
zero hassle.

Our way



Email us



Replacement



You

Their way



Re-package item



Schedule pick up



Track package



Replacement









You

We really don't want you to go through the hassle of re-packaging your item
and sending it back, because let's be honest...nobody has time for that.

IMPORTANT/ WICHTIG/ IMPORTANT/ IMPORTANTE/ IMPORTANTE/ 重要

SAFETY ADVICE/ SICHERHEITSHINWEISE/ CONSEILS DE SÉCURITÉ/ CONSEJO DE SEGURIDAD/
CONSIGLIDI SICUREZZA/ 安全アドバイス

	<p>EN - We recommend 1 or more people to install. DE - Wir empfehlen die Installation durch eine oder mehrere Personen. ES - Recomendamos que lo instalen 1 o más personas. FR - Nous recommandons à 1 ou plusieurs personnes de l'installer. IT - Si consiglia l'installazione da 1 o più persone. JP - 1人以上の作業者が取り付けを行うことをお勧めします。</p>
	<p>EN - The expected assembly time is 2 h. DE - Die voraussichtliche Montagezeit beträgt 2 Stunden. ES - El tiempo previsto de montaje es de 2 h. FR - Le temps de montage prévu est de 2 heures. IT - Il tempo di montaggio previsto è di 2 h. JP - 組み立てにかかる予想時間は2時間です。</p>
	<p>EN - Not intended for use by children. DE - Nicht geeignet für Kinder. ES - Producto no apto para niños. FR - Produit non destiné à être utilisé par des enfants. IT - Questo prodotto non è destinato all'uso da parte dei bambini. JP - お子様用ではありません。</p>
	<p>EN - Keep away from fire or other heat sources. DE - Bitte von Feuer und Hitzequellen fernhalten. ES - Manténgase alejado de las llamas y otras fuentes de calor. FR - Tenir à distance des flammes et autres sources de chaleur. IT - Tenere lontano dal fuoco o da altre fonti di calore. JP - 火やその他の熱源から離して保管してください。</p>
	<p>EN - We recommend wearing protective gloves. DE - Wir empfehlen das Tragen von Schutzhandschuhen. ES - Recomendamos el uso de guantes de seguridad. FR - Il est recommandé de porter des gants de protection. IT - Si consiglia di indossare guanti protettivi. JP - 保護手袋を着用することをお勧めする。</p>
	<p>EN - Do not overload. DE - Kann nicht überladen werden. ES - No sobrecargues. FR - Ne surchargez pas. IT - Non posso sovraccaricare. JP - 過積載しないでください。</p>

CARE ADVICE / PFLEGEHINWEISE / CONSEILS D'ENTRETIEN / CONSEJOS DE CUIDADO / CONSIGLI PERLACURA / ケアアドバイス

	<p>EN - Wipe with soft dry cloth. DE - Mit einem weichen, trockenen Tuch abwischen. ES - Limpie con un paño suave y seco. FR - Essuyer avec un chiffon doux et sec. IT - Pulire con un panno morbido e asciutto. JP - 柔らかい乾いた布で拭いてください。</p>
---	--

	<p>EN - Never allow any sharp objects to touch the surface. DE - Lassen Sie niemals zu, dass scharfe Gegenstände die Oberfläche berühren. ES - Nunca permita que ningún objeto afilado toque la superficie. FR - Ne laissez jamais aucun objet pointu toucher la surface. IT - Non permettere mai che oggetti appuntiti tocchino la superficie. JP - 表面に鋭利な物体が触れないようにしてください。</p>
---	---

	<p>EN - Never allow any kind of liquid to remain on the surface. DE - Lassen Sie niemals zu, dass Flüssigkeiten auf der Oberfläche verbleiben. ES - Nunca permita que quede ningún tipo de líquido en la superficie. FR - Ne laissez jamais aucun type de liquide rester sur la surface. IT - Non lasciare mai alcun tipo di liquido sulla superficie. JP - 表面に液体が残らないようにしてください。</p>
---	---

	<p>EN - Please periodically check all fittings and re-tighten as necessary. DE - Bitte überprüfen Sie regelmäßig alle Anschlüsse und ziehen Sie sie bei Bedarf nach. ES - Revise periódicamente todos los accesorios y vuelva a apretarlos según sea necesario. FR - Veuillez vérifier périodiquement tous les raccords et resserrer si nécessaire. IT - Si prega di controllare periodicamente tutti i raccordi e di serrarli nuovamente se necessario. JP - 定期的 にすべての取り付け具をチェックし、必要に応じて再締めしてください。</p>
---	--

ASSEMBLY ADVICE / MONTAGEHINWEIS / CONSEILS DE MONTAGE / CONSEJOS DE MONTAJE / CONSIGLI DI MONTAGGIO / 組立アドバイス

	<p>EN - Ensure that you have sufficient space to assemble the product safely. DE - Stellen Sie sicher, dass ausreichend Platz für die sichere Montage des Produkts vorhanden ist. ES - Asegúrese de tener suficiente espacio para montar el producto de forma segura. FR - Assurez-vous de disposer de suffisamment d'espace pour assembler le produit en toute sécurité. IT - Assicurarsi di disporre di spazio sufficiente per assemblare il prodotto in modo sicuro. JP - 製品を安全に組み立てるための十分なスペースを確保してください。</p>
---	---

	<p>EN - Please check that all parts are present before you start the assembly. A Phillips screwdriver (not included) is required for the assembly. DE - Bitte überprüfen Sie, ob alle Teile vorhanden sind, bevor Sie mit der Montage beginnen. Für die Montage wird ein Kreuzschlitzschraubendreher (nicht im Lieferumfang enthalten) benötigt. ES - Verifique que todas las piezas estén presentes antes de comenzar el montaje. Se requiere un destornillador Phillips (no incluido) para el montaje. FR - Veuillez vérifier que toutes les pièces sont présentes avant de commencer le montage. Un tournevis cruciforme (non inclus) est requis pour l'assemblage. IT - Si prega di verificare che tutte le parti siano presenti prima di iniziare il montaggio. Per il montaggio è necessario un cacciavite a croce (non incluso). JP - 家具の組み立てを始める前に、すべての部品が揃っていることを確認してください。本製品の組み立てには、フィリップスドライバー（別売り）が必要です。</p>
---	---



EN - ① During the process of assembly, do not fully tighten bolts or screws until all bolts or screws are lined up and inserted into holes; ② do not over-tighten the screws or bolts to avoid stripping; ③ It is not recommended to use power tools.

DE - ① Ziehen Sie während des Montagevorgangs die Bolzen oder Schrauben erst dann vollständig fest, wenn alle Bolzen oder Schrauben ausgerichtet und in die Löcher eingesetzt sind; ② Ziehen Sie die Schrauben oder Bolzen nicht zu fest an, um ein Abisolieren zu vermeiden; ③ Es wird nicht empfohlen, Elektrowerkzeuge zu verwenden.

ES - ① Durante el proceso de montaje, no apriete completamente los pernos o tornillos hasta que todos los pernos o tornillos estén alineados e insertados en los orificios; ② no apriete demasiado los tornillos o pernos para evitar que se pelen; ③ No se recomienda utilizar herramientas eléctricas.

FR - ① Pendant le processus d'assemblage, ne serrez pas complètement les boulons ou les vis jusqu'à ce que tous les boulons ou vis soient alignés et insérés dans les trous; ② ne serrez pas trop les vis ou les boulons pour éviter de les dénuder; ③ Il n'est pas recommandé d'utiliser des outils électriques.

IT - ① Durante il processo di assemblaggio, non serrare completamente i bulloni o le viti finché tutti i bulloni o le viti non sono allineati e inseriti nei fori; ② non stringere eccessivamente le viti o i bulloni per evitare di strapparli; ③ Non è consigliabile utilizzare utensili elettrici.

JP - 組み立て作業中は、全てのボルトやネジが穴に合って挿入されるまで、ボルトやスクリューを完全に締め付けしないでください。ネジやボルトを締めすぎないでください。電動工具を使用しないでください。



EN - Please follow the instruction manuals and use a pad to avoid damage during assembly.

DE - Bitte befolgen Sie die Bedienungsanleitungen und verwenden Sie eine Unterlage, um Schäden beim Zusammenbau zu vermeiden.

ES - Siga los manuales de instrucciones y utilice una almohadilla para evitar daños durante el montaje.

FR - Veuillez suivre les manuels d'instructions et utiliser un tampon pour éviter tout dommage lors du montage.

IT - Seguire i manuali di istruzioni e utilizzare un tampone per evitare danni durante il montaggio.

JP - 組み立て時に損傷を防ぐために、取扱説明書に従い、パッドを使用してください。

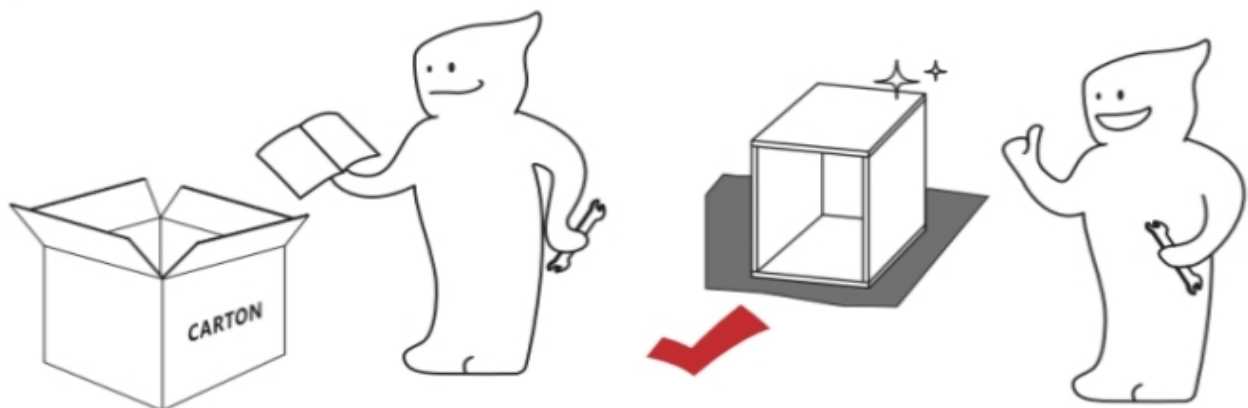
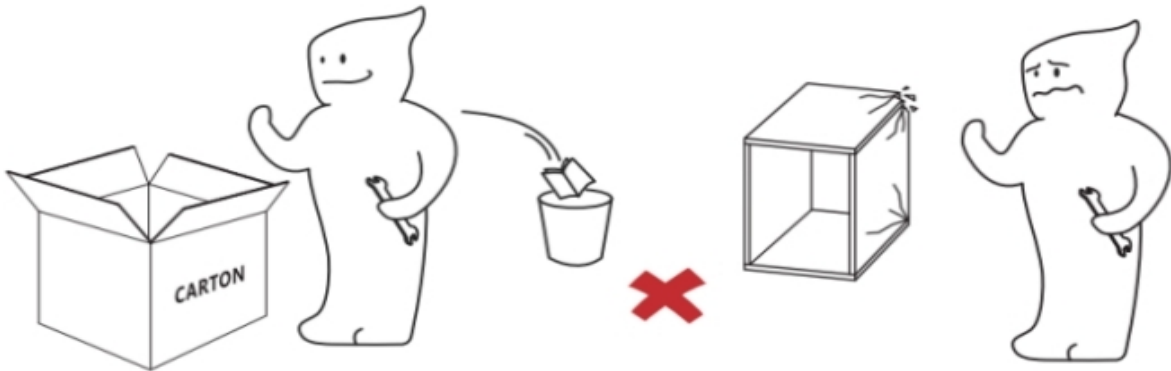

**ASSEMBLY DIAGRAM/ MONTAGEDIAGRAMM/ SCHÉMA DE MONTAGE/
DIAGRAMA DE MONTAJE/ SCHEMA DI MONTAGGIO/ 組み立て図**

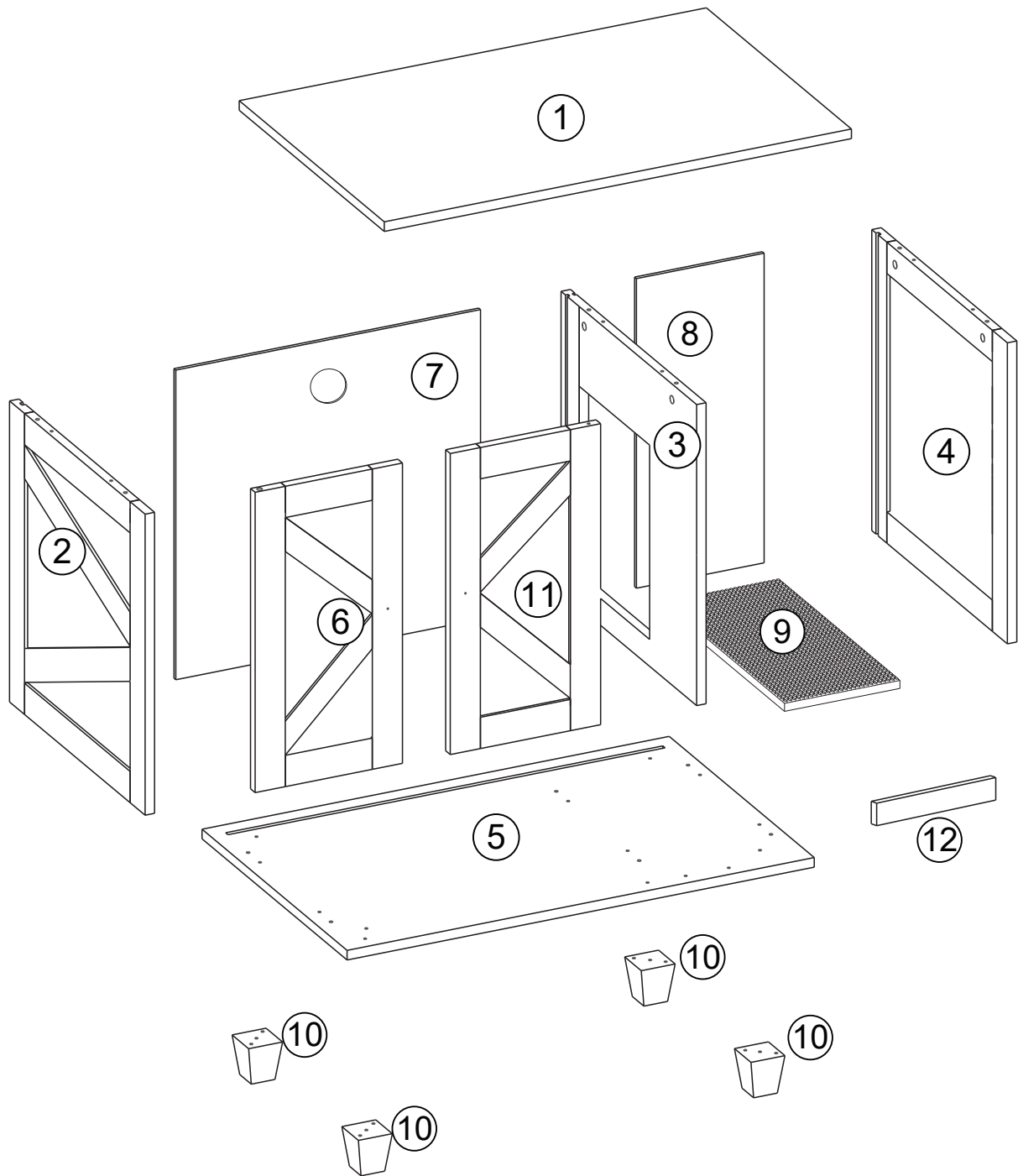

Whatsapp: + 19094557520



Email:
service@giluta.com

EN - If there are any parts missing, damaged or defective, please feel free to contact us for support via the following email.

DE - Sollten Teile fehlen, beschädigt oder defekt sein, können Sie sich gerne über die folgende E-Mail an uns wenden, um Unterstützung zu erhalten.







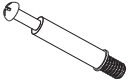

ES - Si falta alguna pieza, está dañada o defectuosa, no dude en contactarnos para obtener asistencia a través del siguiente correo electrónico.

FR - S'il manque des pièces, endommagées ou défectueuses, n'hésitez pas à nous contacter pour obtenir de l'aide via l'e-mail suivant.

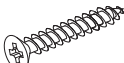
IT - Se ci sono parti mancanti, danneggiate o difettose, non esitate a contattarci per supporto tramite la seguente email.

JP - 不足、損傷、または欠陥のある部品がある場合は、左側のメールアドレスまでお問い合わせください。

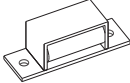
Hardware List/ Hardwareliste/ Liste du matériel/ Lista de hardware/ Elenco dell'hardware/ ハードウェア

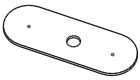
A x6 	B x6 	C x20  M6×30	D x12  M4×35	E x12  M3×14
F x2 	G x2  M4×18	H x8 	I x1 	J x4 
M x2 				

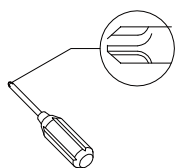

EN - Philips head screwdriver required for assembly (not included)

DE - Für die Montage ist ein Kreuzschlitzschraubendreher erforderlich (nicht im Lieferumfang enthalten)

ES - Se requiere un destornillador de cabeza Philips para el montaje (no incluido)

FR - Tournevis cruciforme requis pour l'assemblage (non inclus)

IT - Cacciavite Philips necessario per il montaggio (non incluso)

JP - 組み立てには、フィリップスドライバー（別売り）が必要です。

1

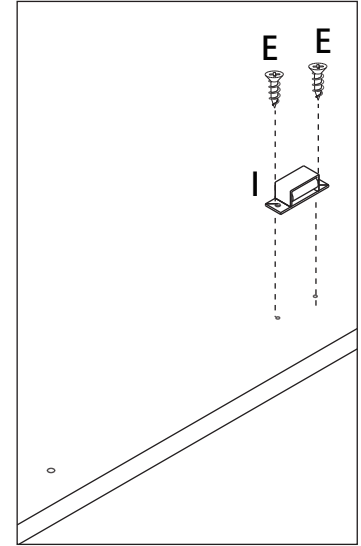
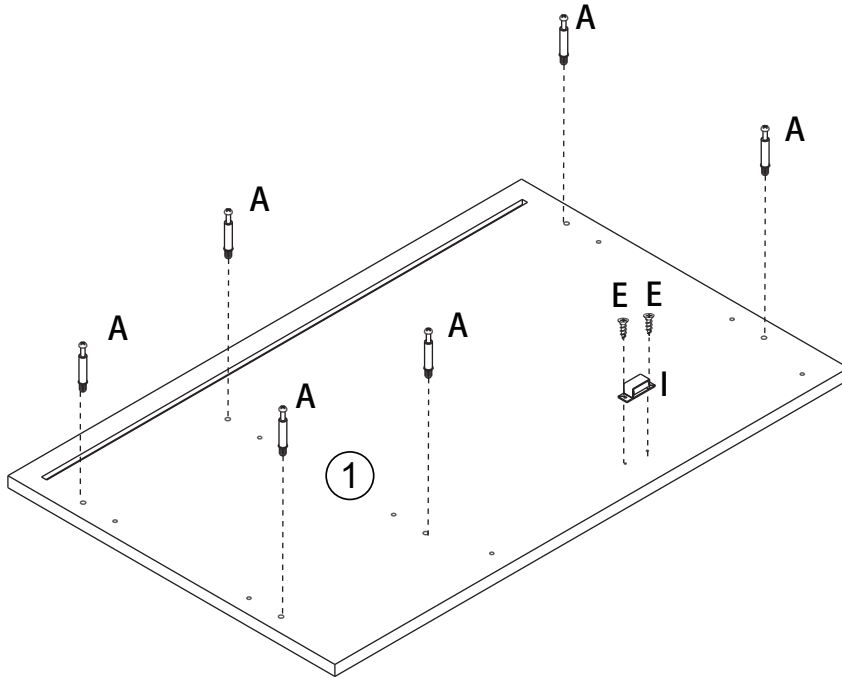
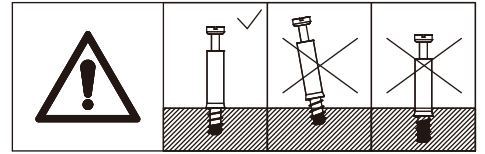
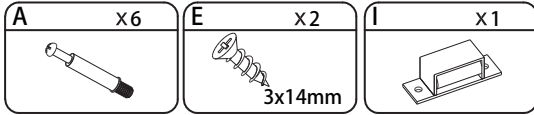

2

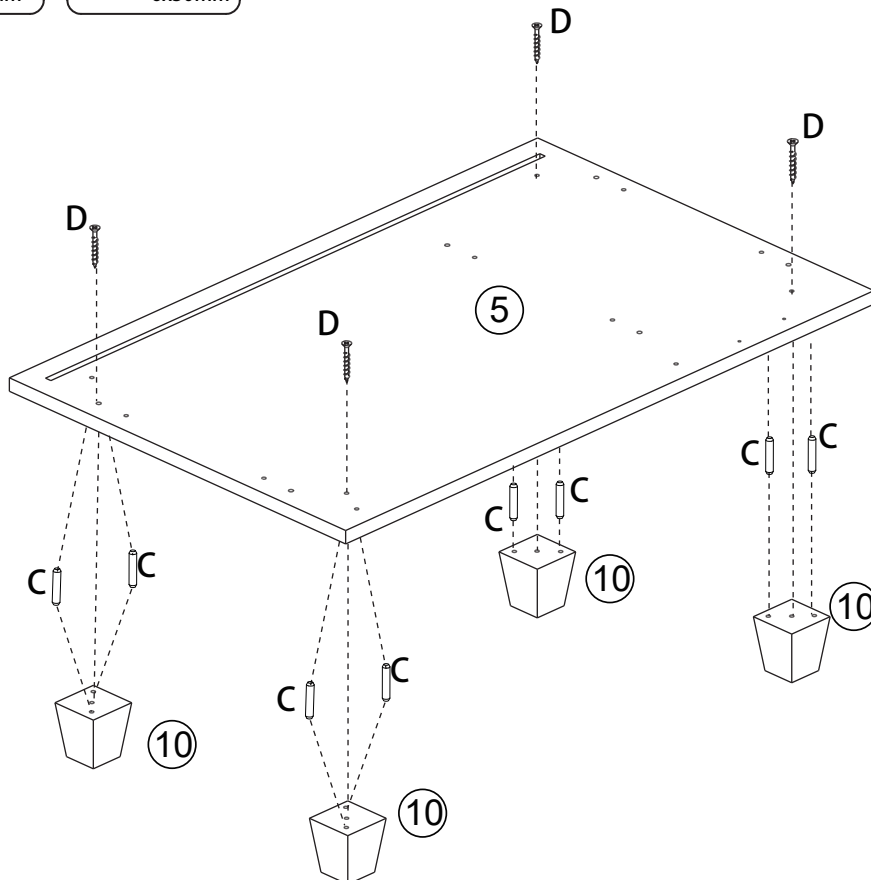
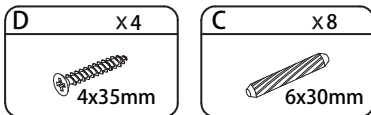

3

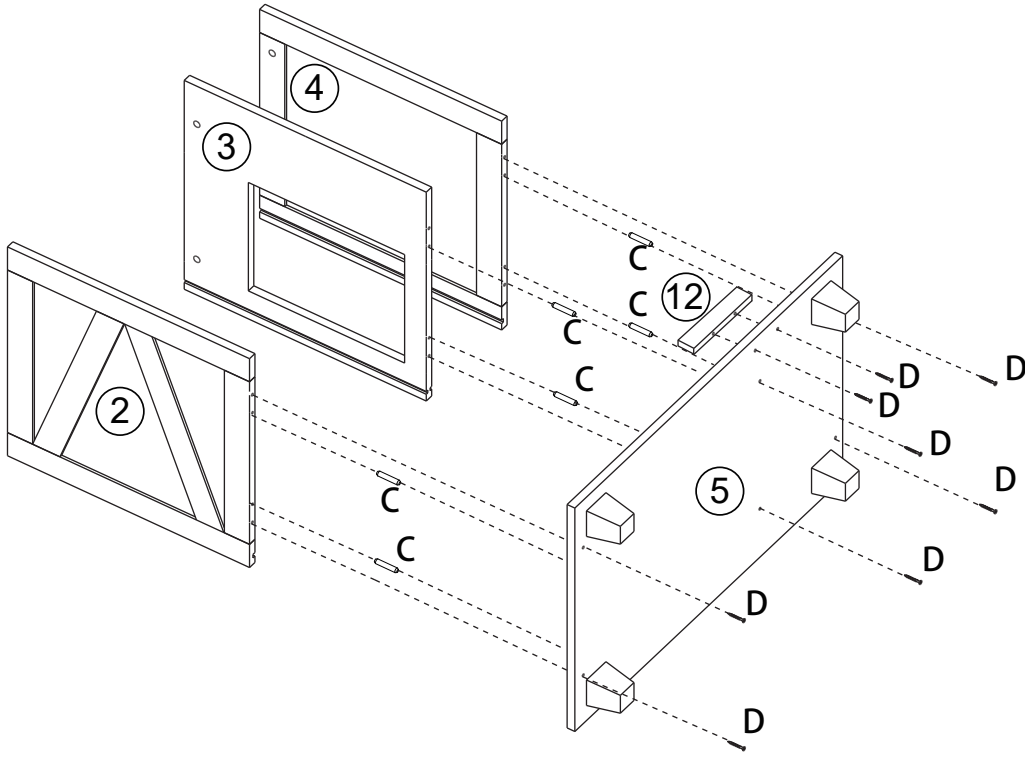
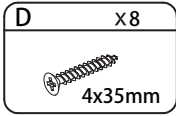
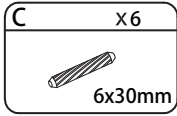

4

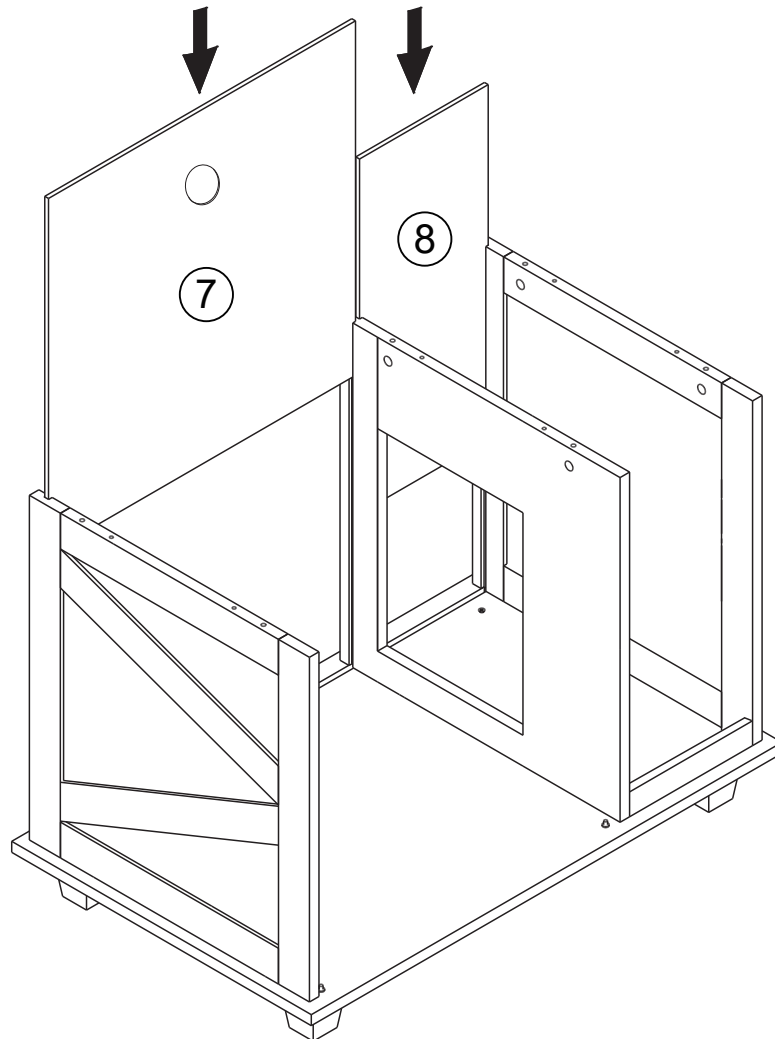

5

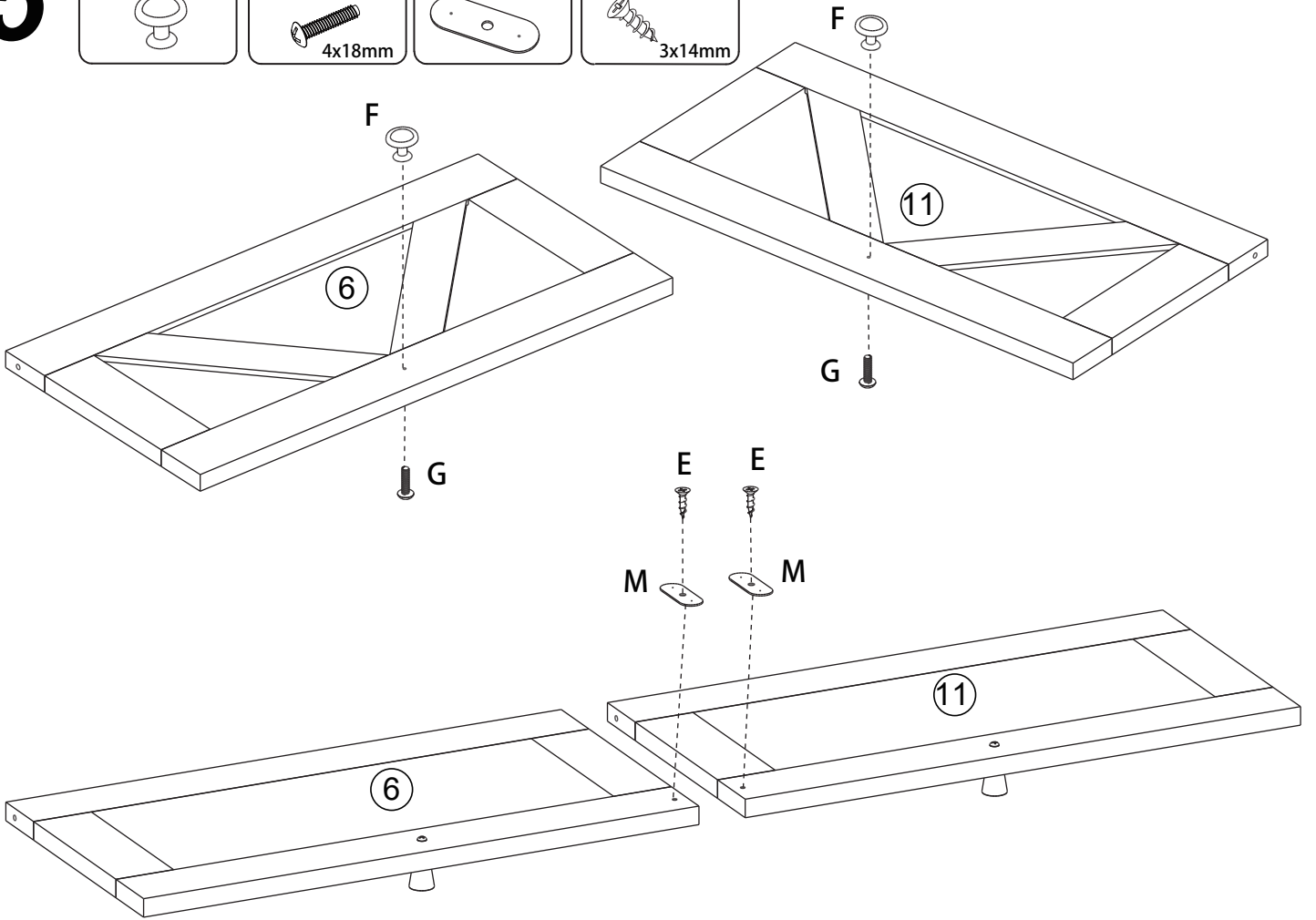
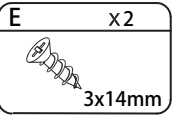
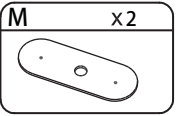
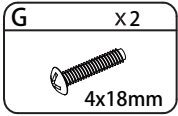
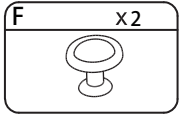

6

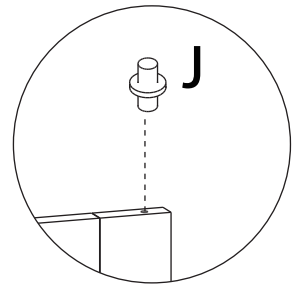
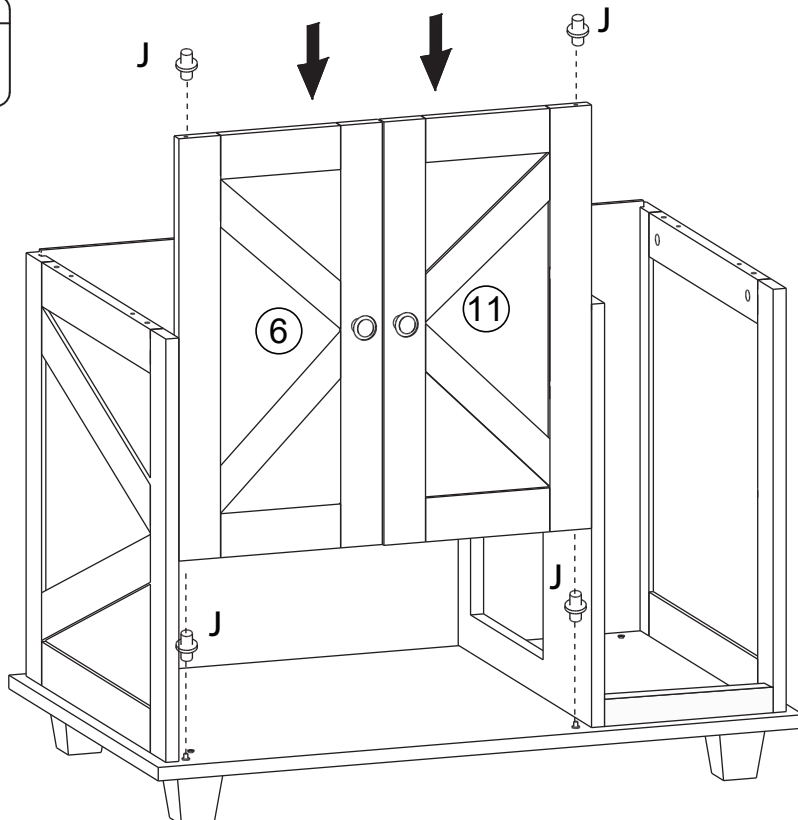
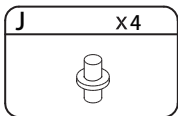

7

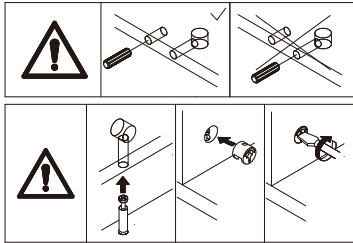
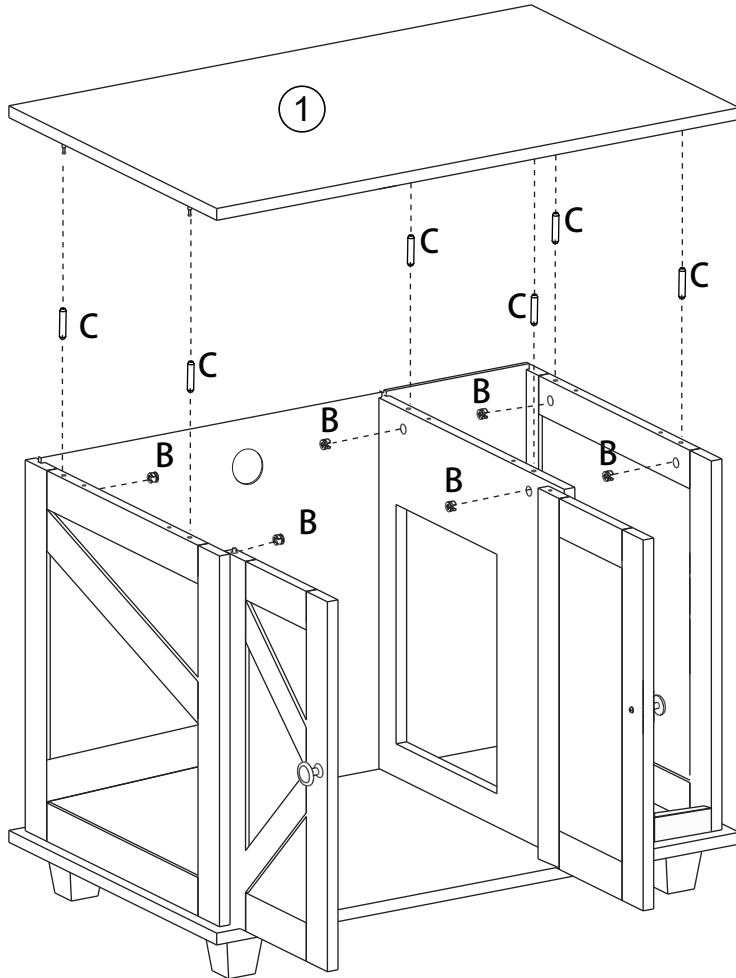
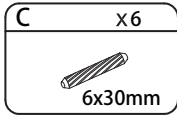
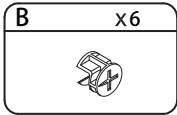

8

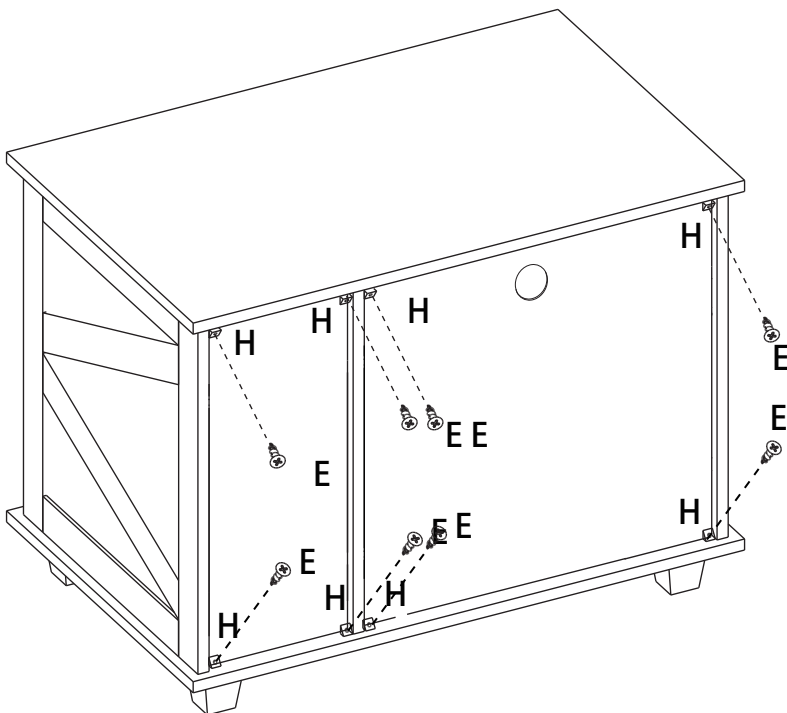
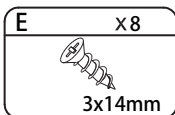
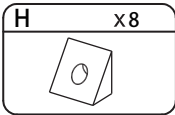

EN - This is a very important step that can not be skipped. Please follow the step to screw the plastic pieces into the corner of the back panel tightly. If you forget to fix these pieces, it may result in the instability of the whole item.

DE - Dies ist ein sehr wichtiger Schritt, der nicht übersprungen werden kann. Bitte folgen Sie den Schritten, um die Kunststoffteile fest in die Ecke der Rückwand zu schrauben. Wenn Sie vergessen, diese Teile zu befestigen, kann dies zur Instabilität des gesamten Artikels führen.

FR - C'est une étape très importante qui ne peut être ignorée. Veuillez suivre l'étape pour visser fermement les pièces en plastique dans le coin du panneau arrière. Si vous oubliez de réparer ces pièces, cela peut entraîner une instabilité de l'ensemble de l'article.

ES - Este es un paso muy importante que no se puede omitir. Siga el paso para atornillar firmemente las piezas de plástico en la esquina del panel posterior. Si olvida arreglar estas piezas, puede provocar la inestabilidad de todo el artículo.

IT - Questo è un passaggio molto importante che non può essere saltato. Seguire la procedura per avvitare saldamente i pezzi di plastica nell'angolo del pannello posteriore. Se dimentichi di riparare questi pezzi, ciò potrebbe comportare l'instabilità dell'intero articolo.

JP - このステップは非常に重要で、スキップできません。バックパネルの角にプラスチックの部品をしっかりと取り付けるために、このステップに従ってください。これらの部品を取り付けるのを忘れると、製品全体の不安定さにつながる可能性があります。

9

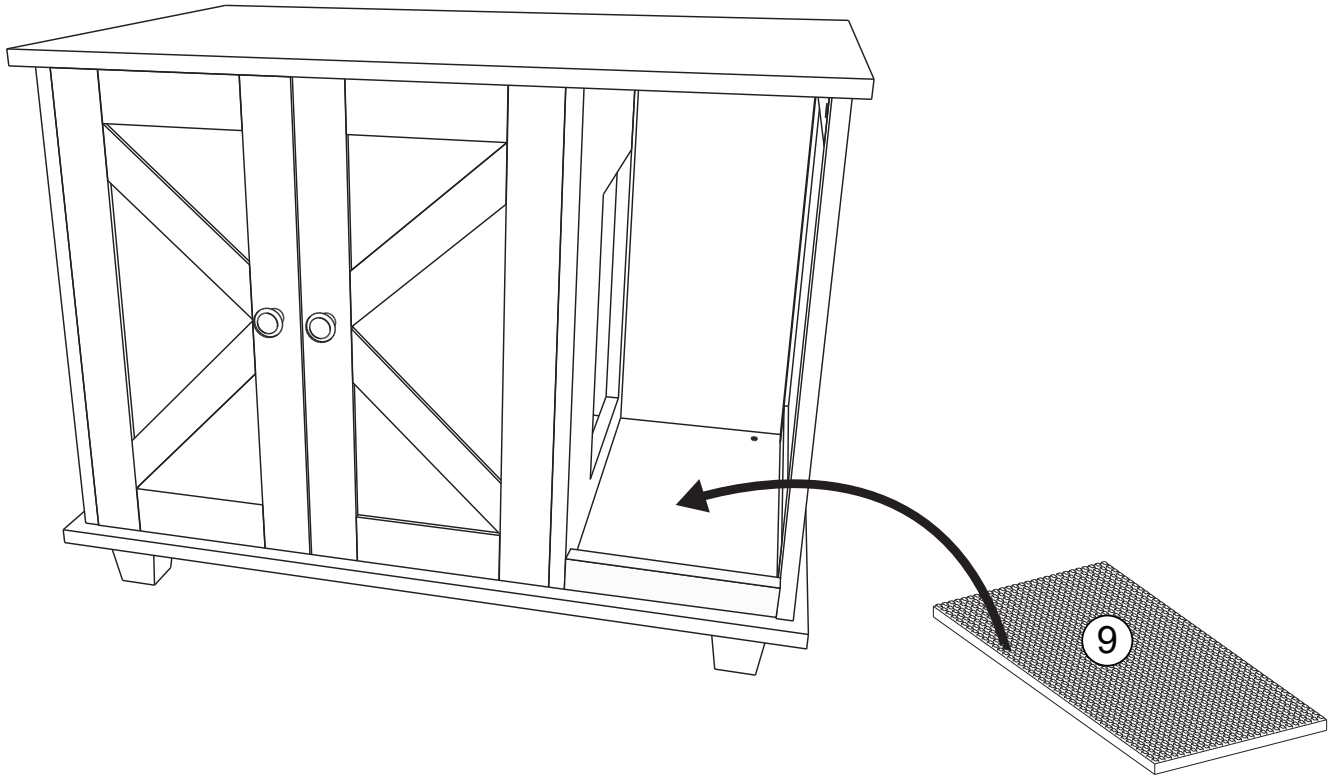

10

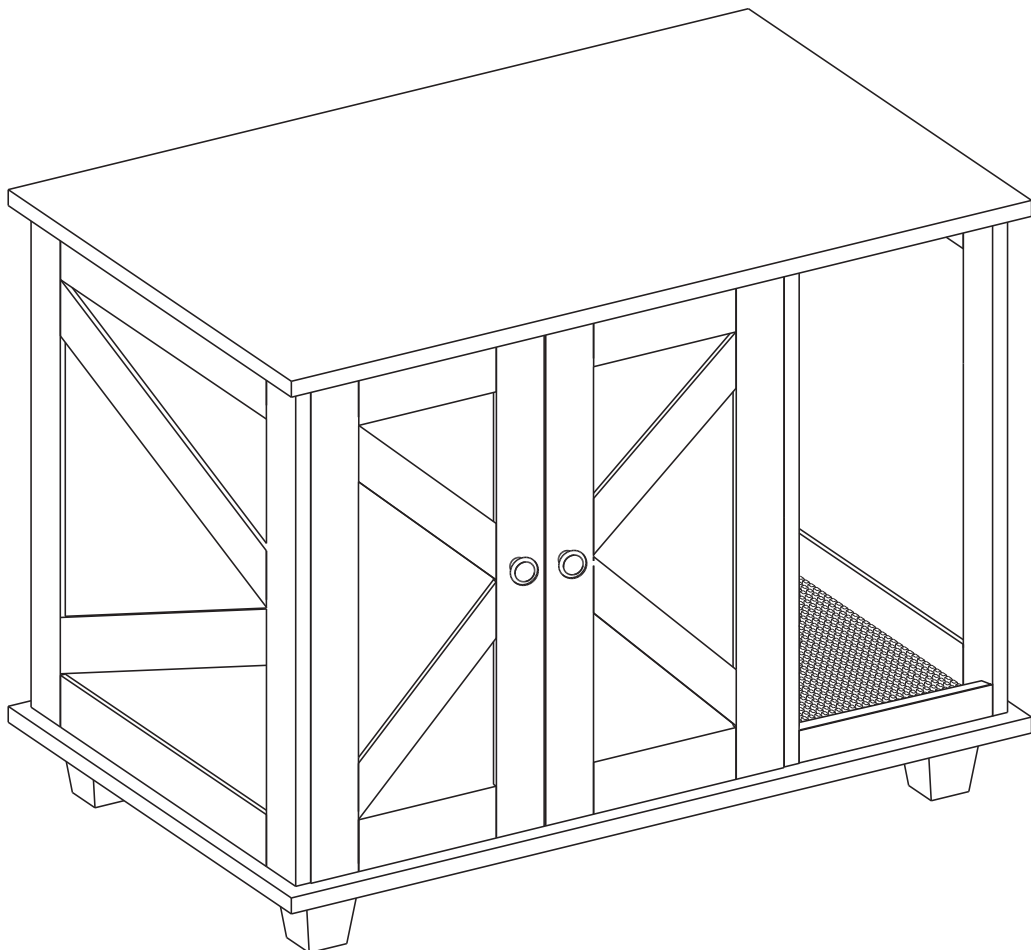

EN	<p>If you are not entirely satisfied with your purchase, please feel free to contact us using the following steps:</p> <ol style="list-style-type: none"> 1. Go to Your Orders. 2. Find your order in the list. 3. Select Problem with order. 4. Choose your topic from list displayed. 5. Select Contact seller.
DE	<p>Sollten Sie mit Ihrem Kauf nicht zufriedensein, nehmen Sie bitte in folgenden Schritten mit uns Kontakt auf:</p> <ol style="list-style-type: none"> 1. Gehen Sie auf die Bestellseite. 2. Suchen Sie Ihre Bestellung in der Bestellliste. 3. Schildern Sie das Problem mit der Bestellung. 4. Thema aus der angezeigten Liste auswählen. 5. Kontakt mit dem Verkäufer aufnehmen.
ES	<p>Si no está completamente satisfecho con su compra, no dude en contactarnos siguiendo los siguientes pasos:</p> <ol style="list-style-type: none"> 1. Ve a Tus Pedidos. 2. Encuentra tu pedido en la lista. 3. Seleccione Problema con el pedido. 4. Elija su tema de la lista que se muestra. 5. Seleccione Contactar al vendedor.
FR	<p>Si vous n'êtes pas entièrement satisfait de votre achat, n'hésitez pas à nous contacter en suivant les étapes suivantes :</p> <ol style="list-style-type: none"> 1. Accédez à Vos commandes. 2. Trouvez votre commande dans la liste. 3. Sélectionnez Problème avec la commande. 4. Choisissez votre sujet dans la liste affichée. 5. Sélectionnez Contacter le vendeur.
IT	<p>Se non sei completamente soddisfatto del tuo acquisto, non esitare a contattarci utilizzando i seguenti passaggi:</p> <ol style="list-style-type: none"> 1. Vai a I tuoi ordini. 2. Trova il tuo ordine nell'elenco. 3. Seleziona Problema con l'ordine. 4. Scegli il tuo argomento dall'elenco visualizzato. 5. Seleziona Contatta il venditore.
JP	<p>ご購入に完全にご満足いただけない場合は、以下の手順に従ってお問い合わせください：</p> <ol style="list-style-type: none"> 1. 「注文履歴」に移動します。 2. リストからご注文を見つけます。 3. 「注文に関する問題」を選択します。 4. 表示されたリストからトピックを選択します。 5. 「出品者に問い合わせる」を選択します。

EN - You can also download the electronic Installation Manual from the Product guides and documents section of the advertising page.

DE - Das elektronische Installationshandbuch können Sie auch im Bereich Produktführungen und Dokumente der Werbeseite herunterladen.

ES - También puede descargar el Manual de instalación electrónica de la Guía del producto y la Sección de documentación de la página de anuncios.

FR - Vous pouvez également télécharger le manuel d'installation électronique à partir de la section Guide produit et documentation de la page publicitaire.

IT - È inoltre possibile scaricare il manuale di installazione elettronico dalla guida del prodotto e dai documenti nella pagina pubblicitaria.

JP - 広告ページの「製品ガイドと文書」セクションから電子取り付けマニュアルをダウンロードすることもできます。