

ASSEMBLY INSTRUCTIONS

5-layers shelf

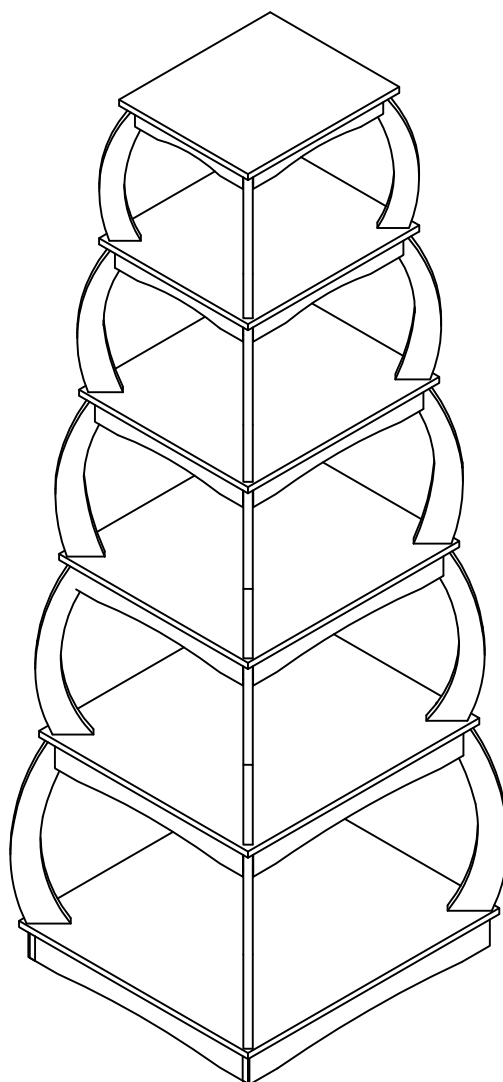

ASSEMBLY TOOLS REQUIRED (NOT INCLUDDE)

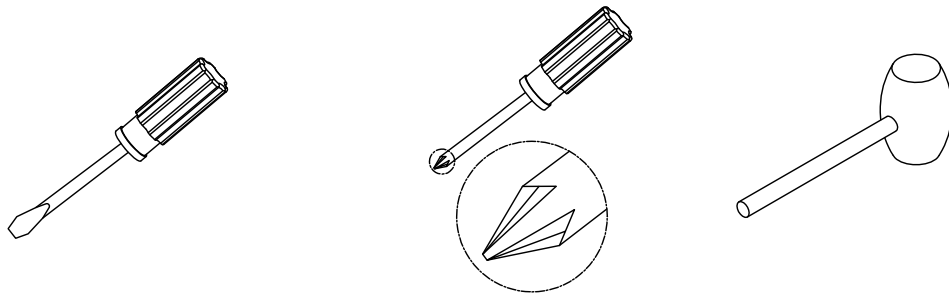





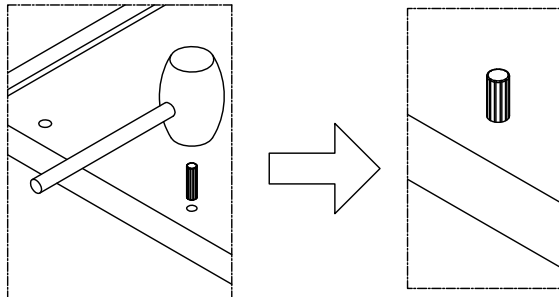



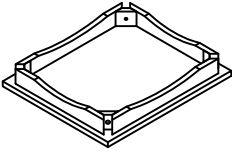

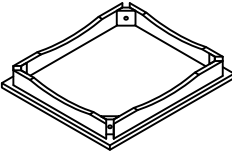
WOODEN DOWEL INSTALLATION PROCEDURE

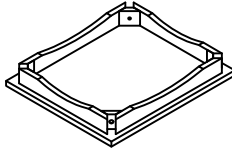
Gently tap dowel into hole with rubber mallet

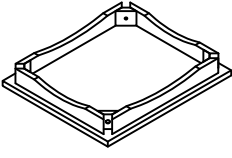

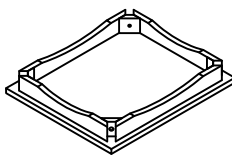

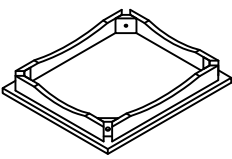
PARTS LIST

A: 1pc 	B: 4pcs 	C: 1pc 	D: 4pcs 
E: 1pc 	F: 4pcs 	G: 1pc 	H: 4pcs 
I: 1pc 	J: 4pcs 	K: 1pc 	

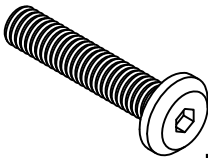
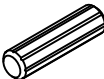
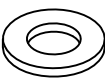
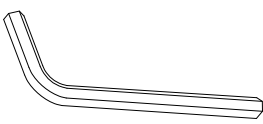
HARDWARE LIST



1: Bolt 40pcs  M6*30	2: Wood plug 20pcs  Ø6*30	3: Washer 20pcs  M6	4: Wrench 1pc  M6
---	--	---	--

Step 1

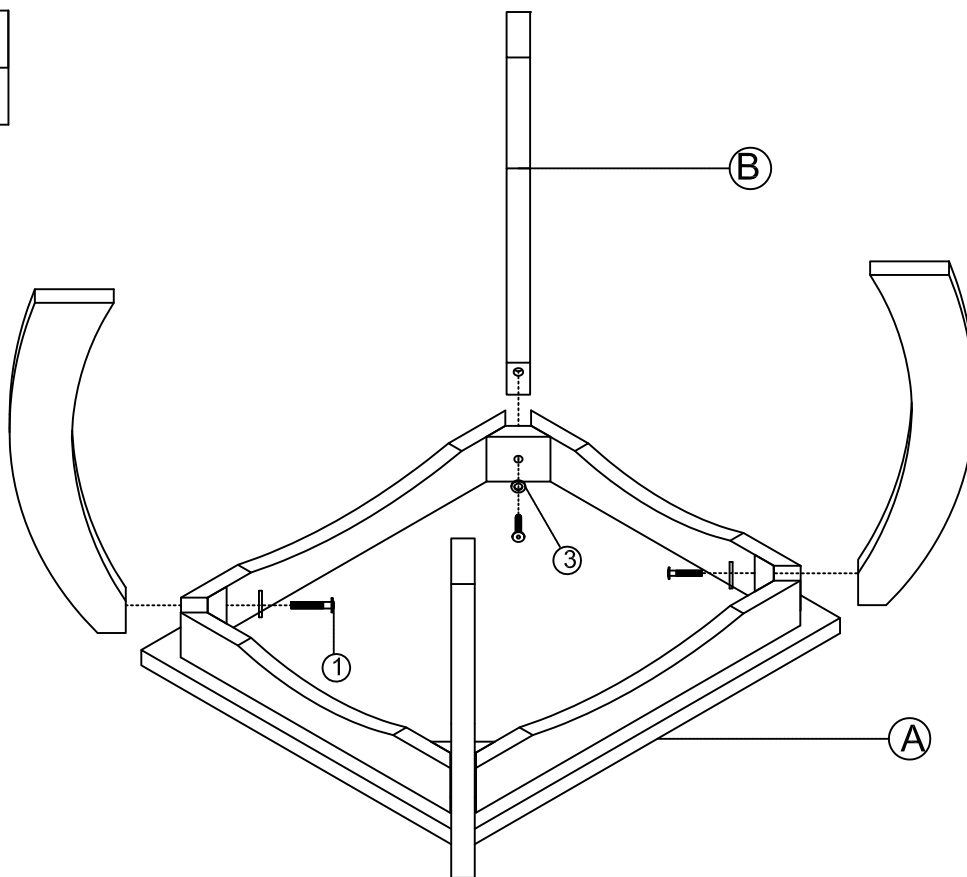
- | | | |
|----|---|------|
| 1: |  | 4pcs |
| 3: |  | 4pcs |



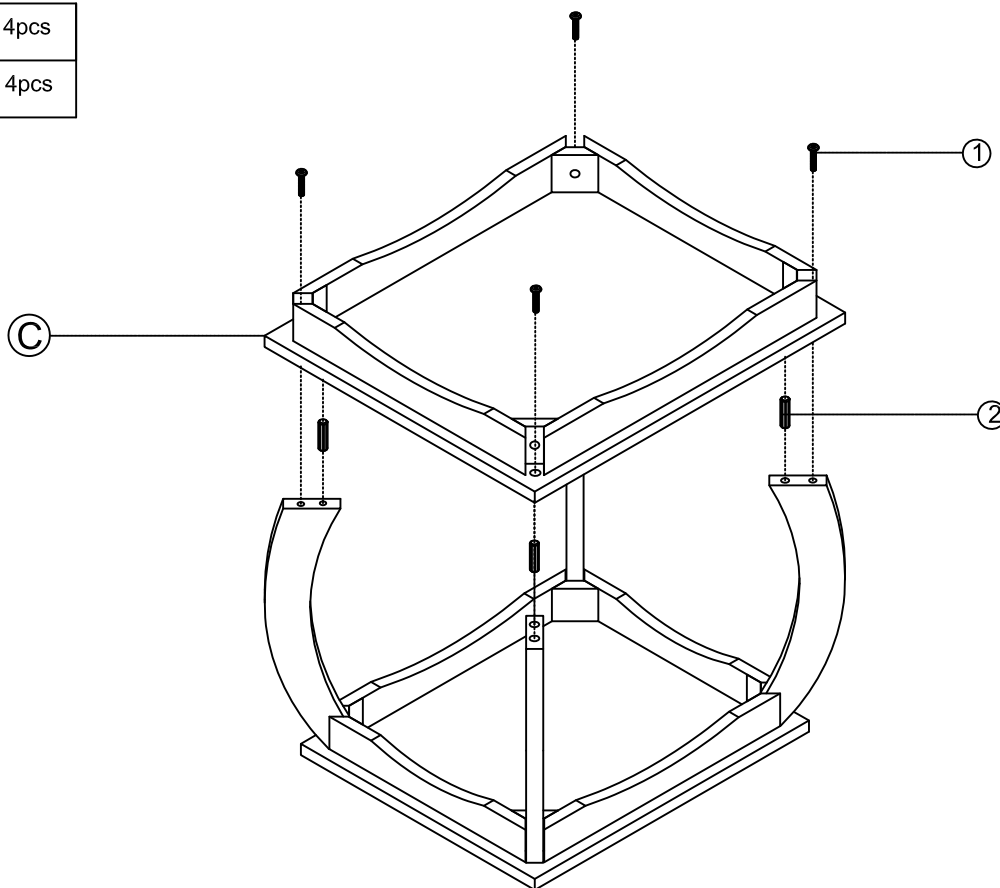

Step 2

- | | | |
|----|---|------|
| 1: |  | 4pcs |
| 2: |  | 4pcs |



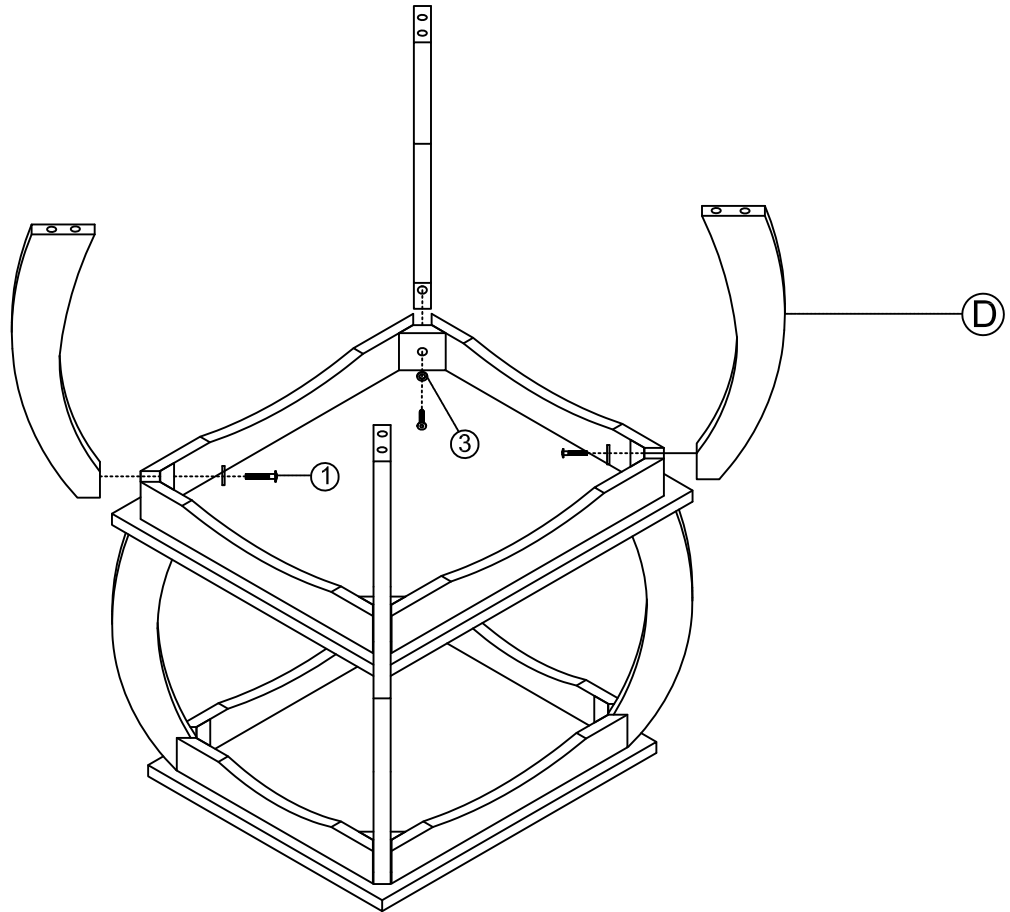

Step 3

1:		4pcs
3:		4pcs



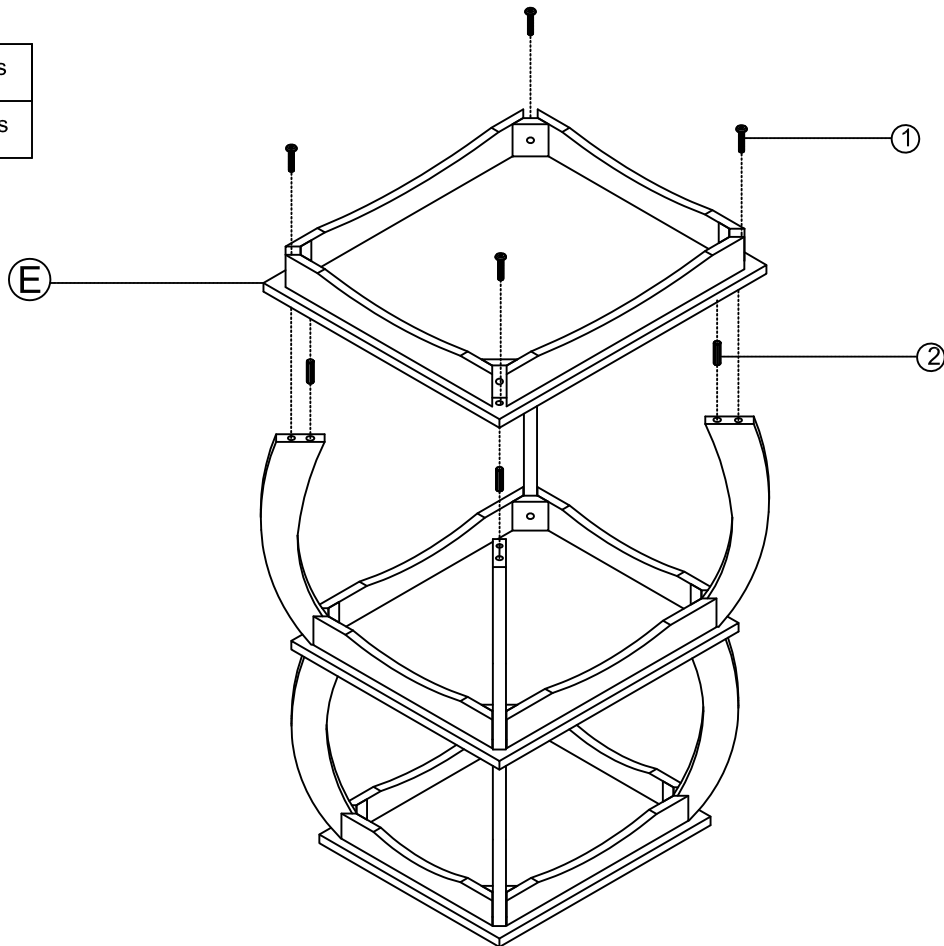

Step 4

1:		4pcs
3:		4pcs



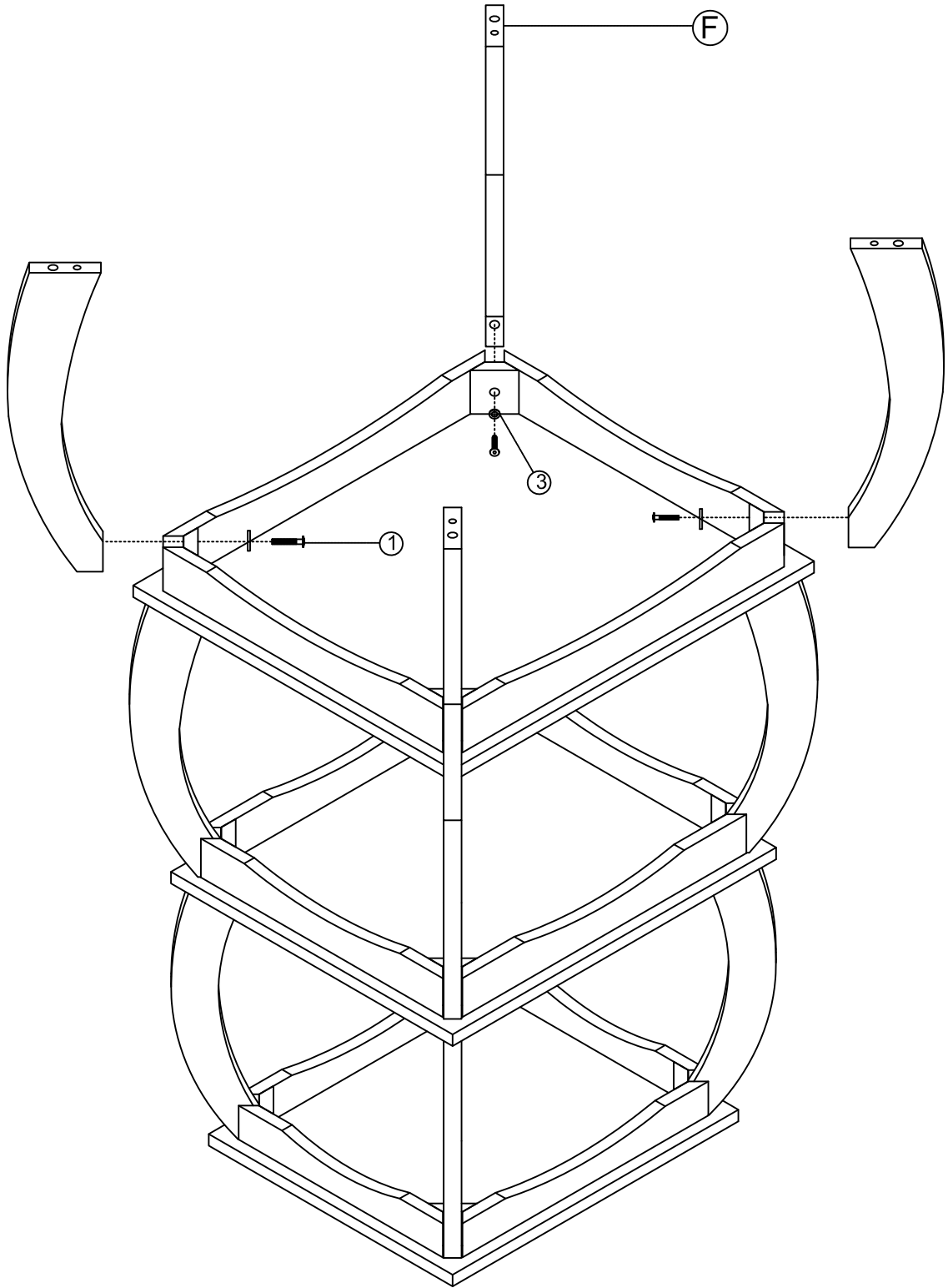

Step 5

- | | | |
|----|---|------|
| 1: |  | 4pcs |
| 3: |  | 4pcs |



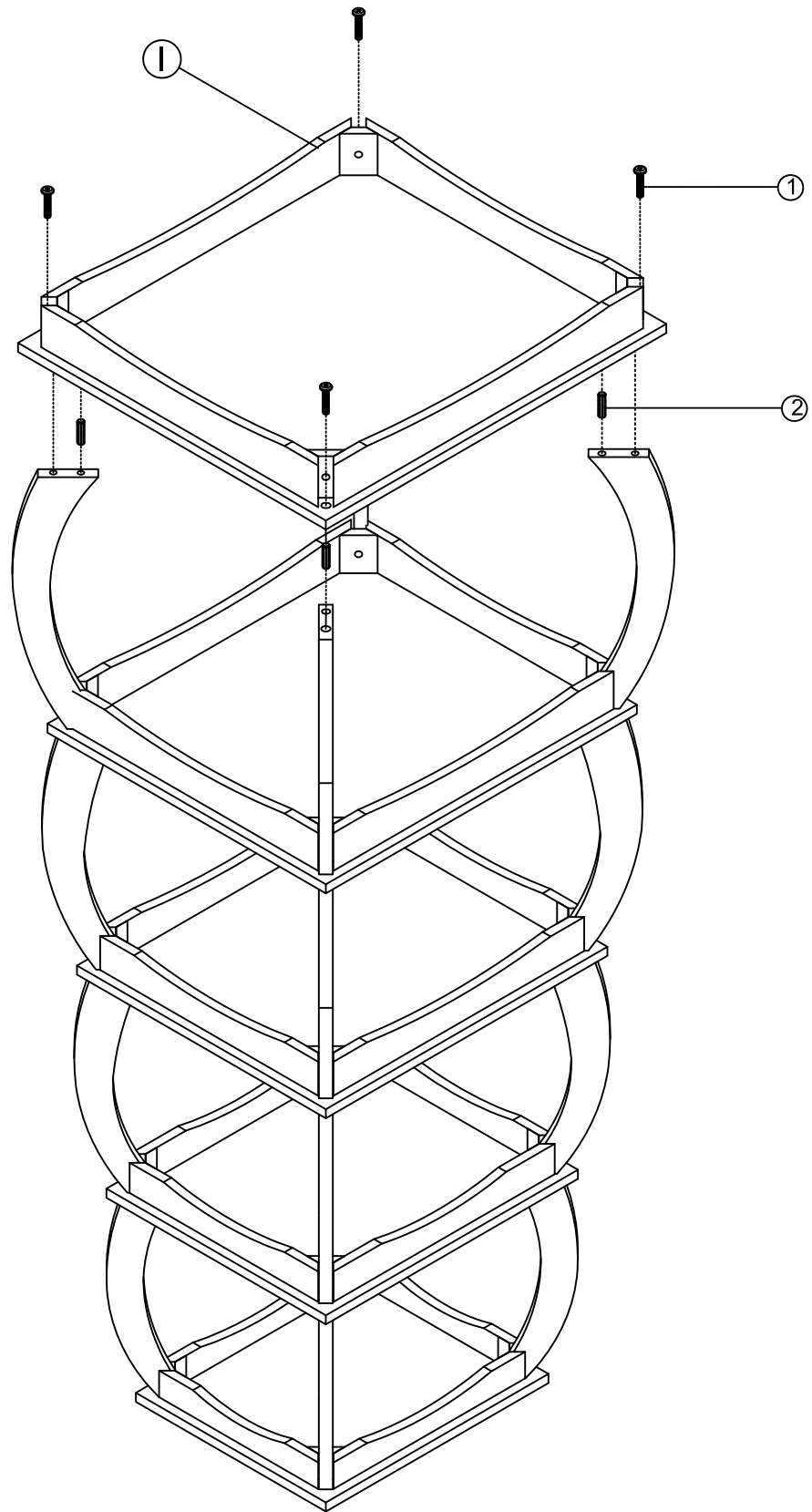

Step 8

- | | | |
|----|---|------|
| 1: |  | 4pcs |
| 3: |  | 4pcs |



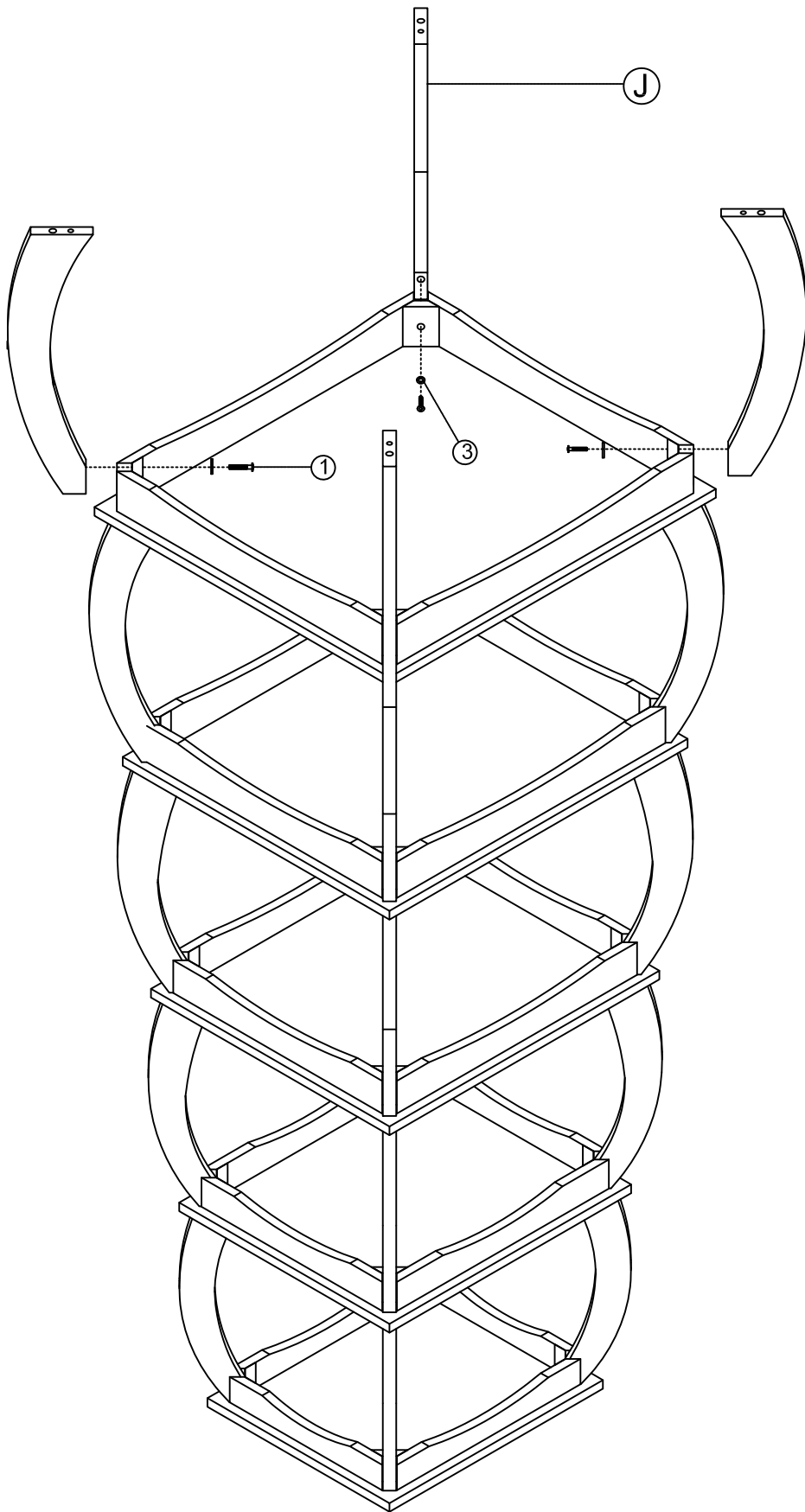

Step 9

- | | | |
|----|---|------|
| 1: |  | 4pcs |
| 3: |  | 4pcs |



Step 10

- | | | |
|----|---|------|
| 1: |  | 4pcs |
| 3: |  | 4pcs |

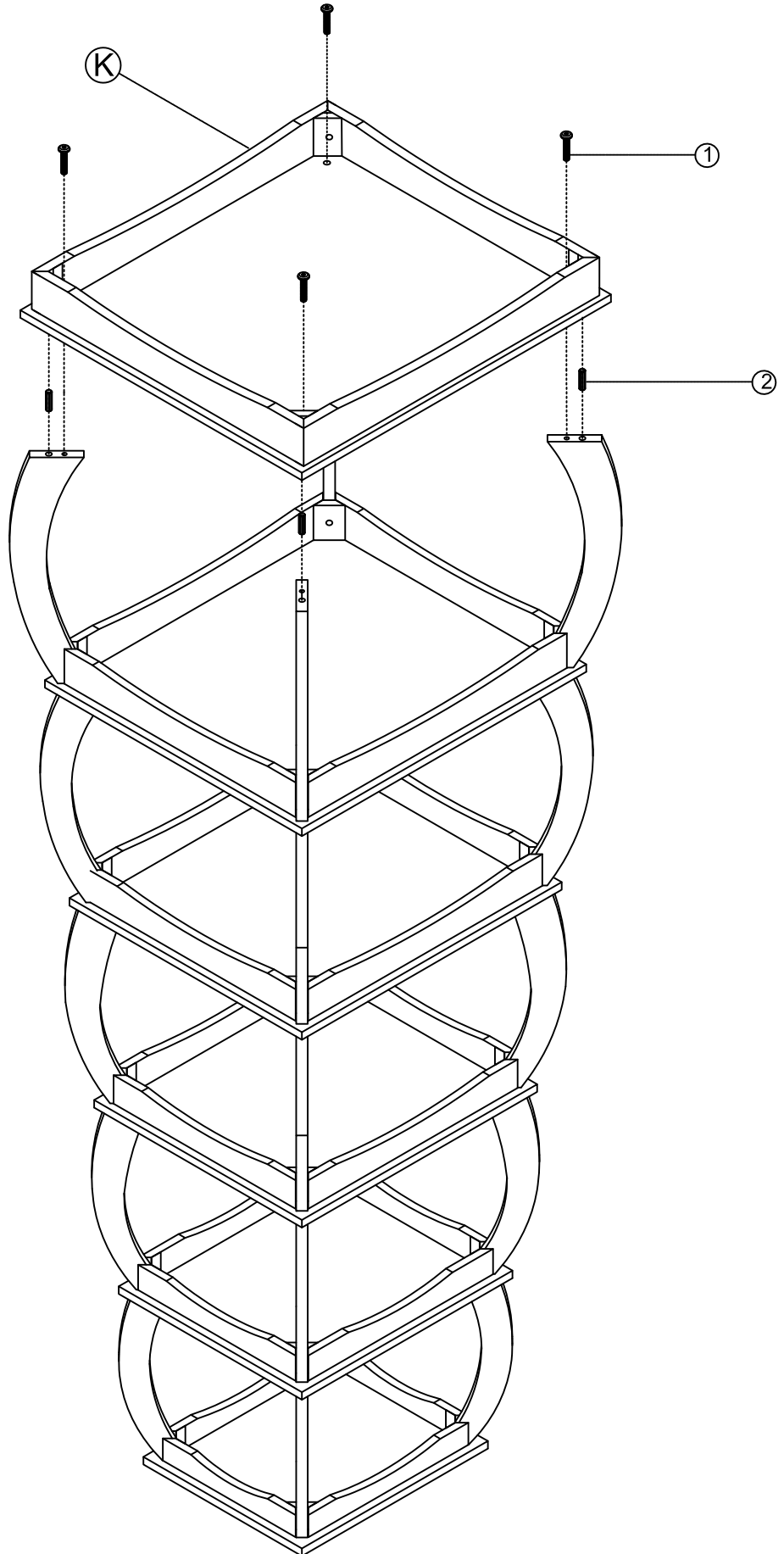

Step 11

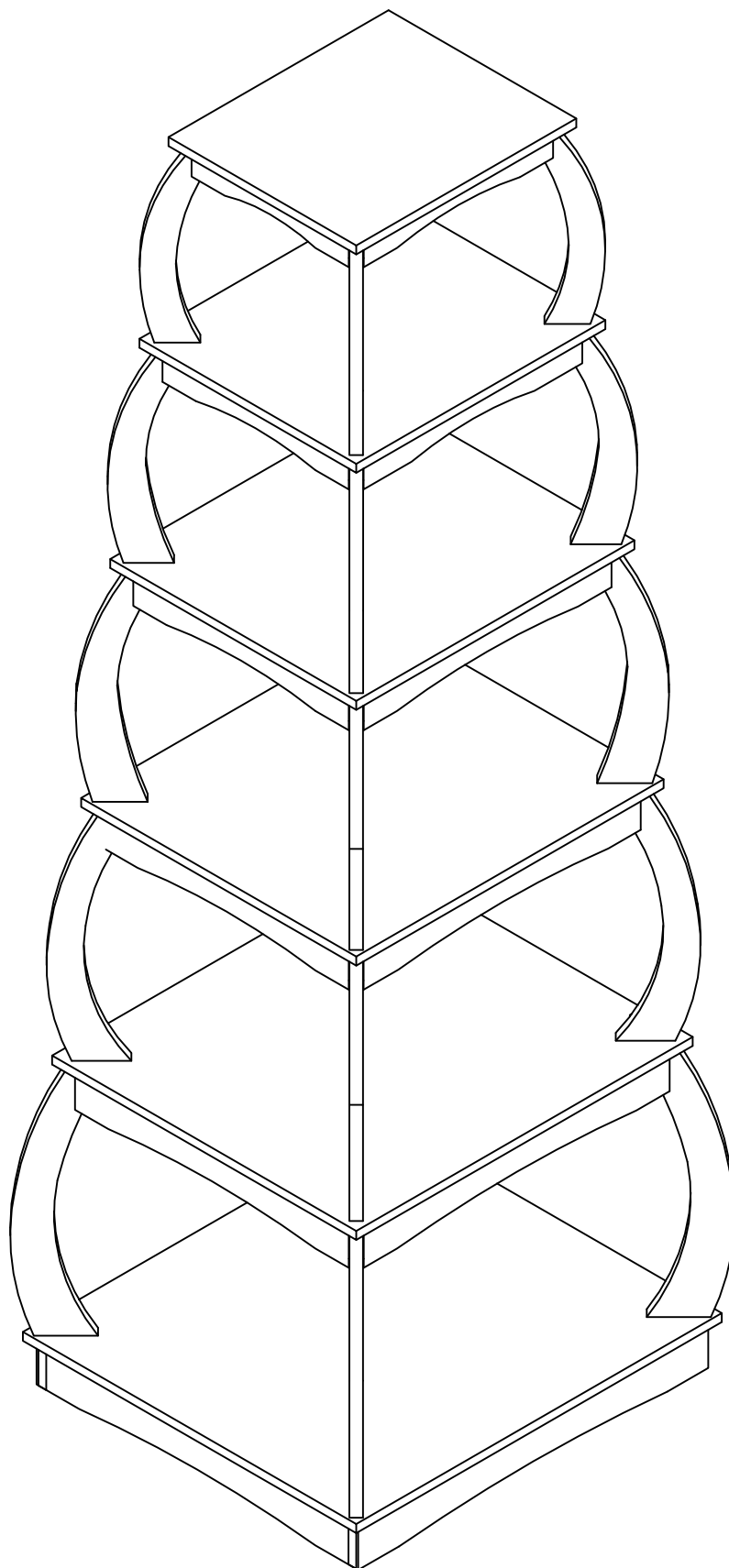

Final Assembly