

ASSEMBLY INSTRUCTION

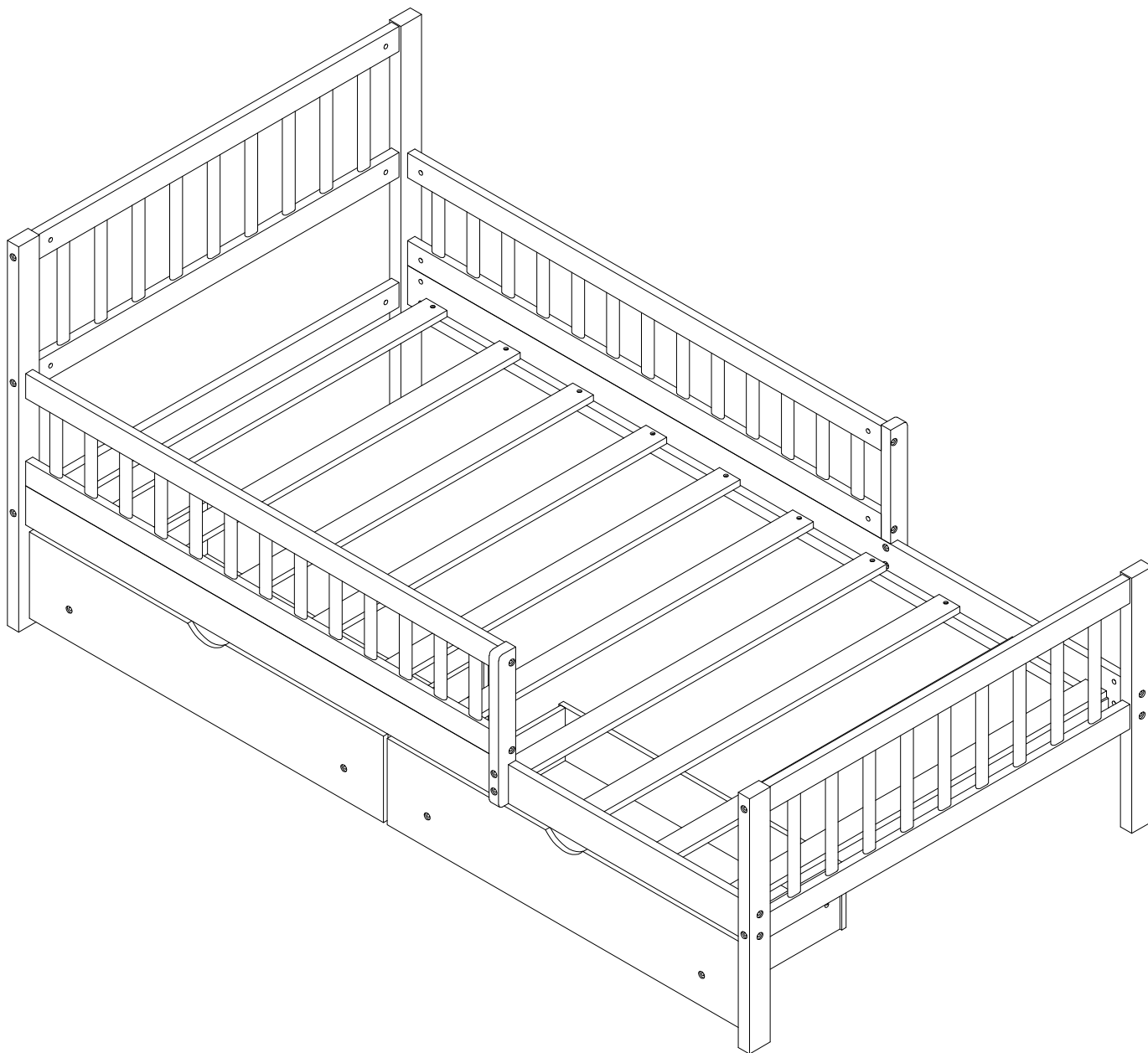





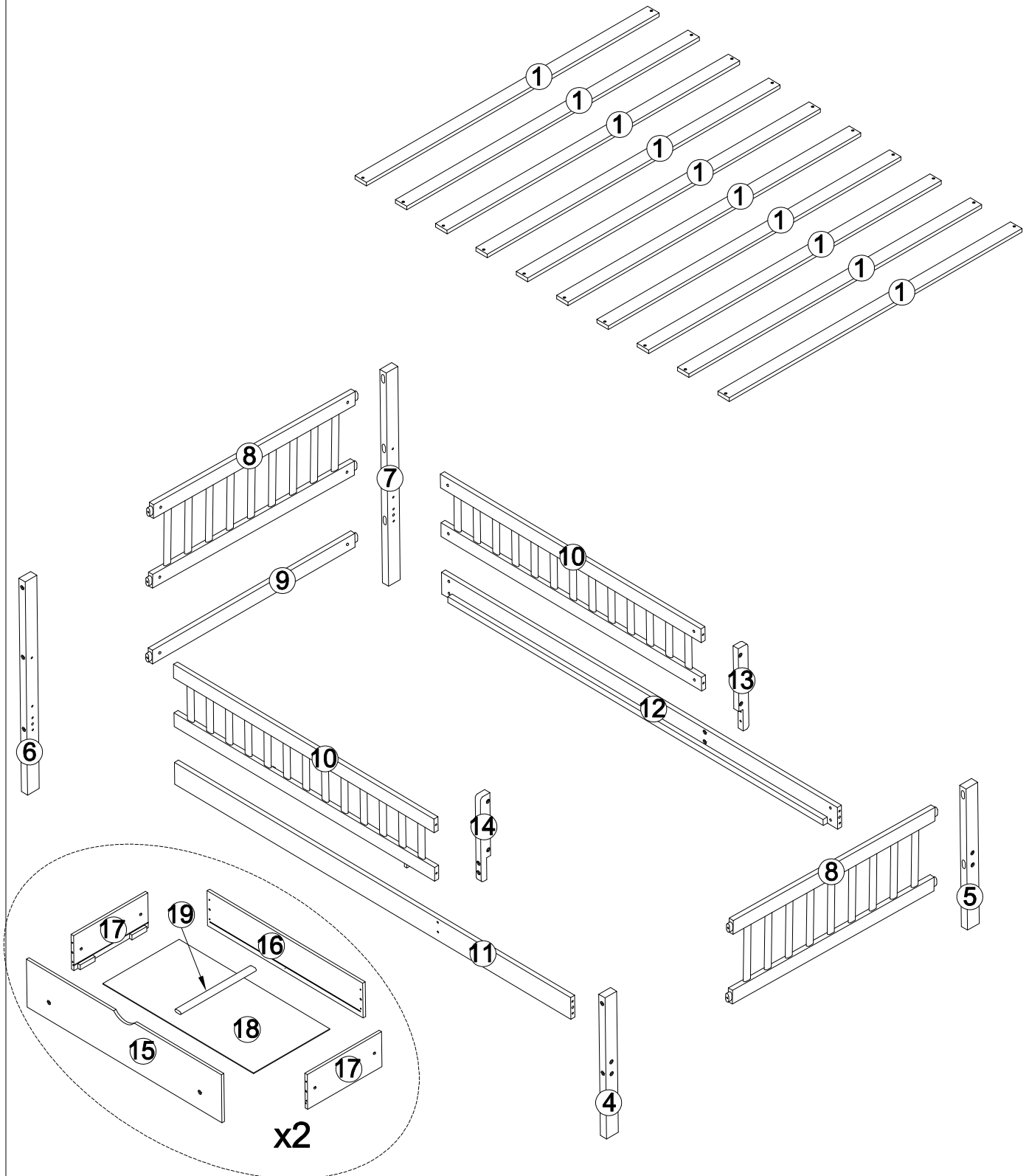

SAFETY WARNINGS AND GENERAL NOTES:

1. Do not use substitute parts. Contact the manufacturer or dealer for replacement parts.
2. Keep these instructions for future reference.
3. We recommend assembling your bed on the shipping carton to protect your floor.
4. Be certain all staples are out of the box before beginning assembly on the shipping carton.
5. Replacement Parts:
Replacement Parts, including additional guardrails, may be obtained from any of our (GIGACLOUD TECHNOLOGY (USA) INC.) dealers.

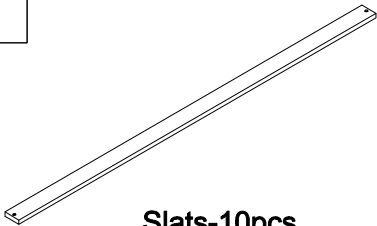

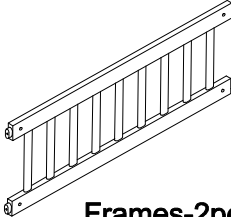
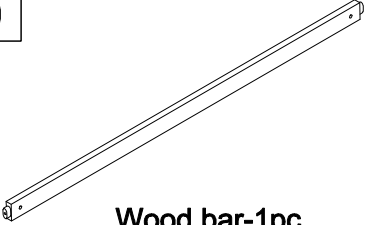
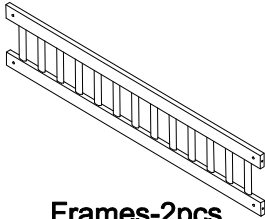
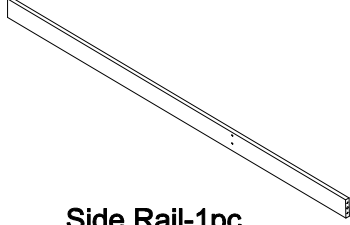
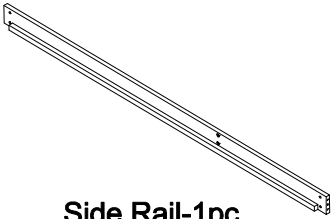

ASSEMBLY INSTRUCTION

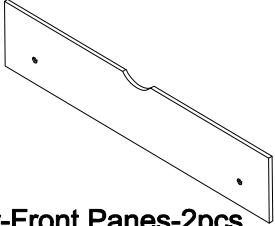
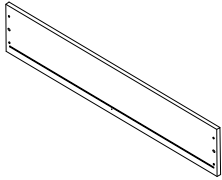
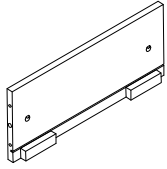
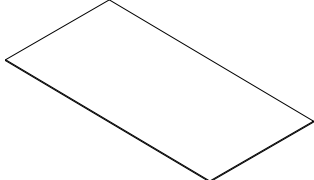
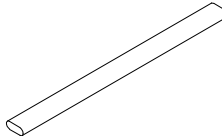

Part List (Box N733P172696)

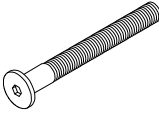
| | | |
|---|---|---|
| <p>1</p>  <p>Slats-10pcs</p> | <p>4</p>  <p>Leg-1pc</p> | <p>5</p>  <p>Leg-1pc</p> |
| <p>6</p>  <p>Leg-1pc</p> | <p>7</p>  <p>Leg-1pc</p> | <p>8</p>  <p>Frames-2pcs</p> |
| <p>9</p>  <p>Wood bar-1pc</p> | <p>10</p>  <p>Frames-2pcs</p> | <p>11</p>  <p>Side Rail-1pc</p> |
| <p>12</p>  <p>Side Rail-1pc</p> | <p>13</p>  <p>Rail-1pc</p> | <p>14</p>  <p>Rail-1pc</p> |
| <p>15</p>  <p>Drawer-Front Panes-2pcs</p> | <p>16</p>  <p>Drawer-Back Panes-2pcs</p> | <p>17</p>  <p>Drawer-Side Panes-4pcs</p> |
| <p>18</p>  <p>Drawer-Bottom Panes-2pcs</p> | <p>19</p>  <p>Drawer-Sup Bottom Panes-2pcs</p> | |

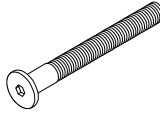
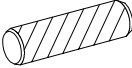
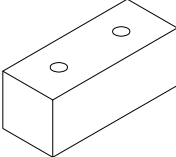
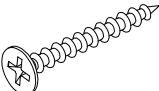
Hardware List

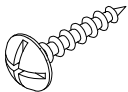
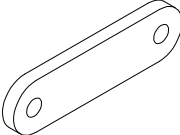
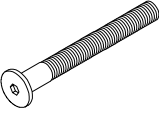
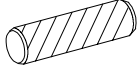
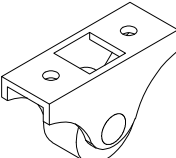
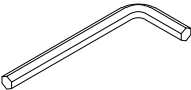
| | | |
|--|--|---|
| <p>A</p>  <p>Ø1/4" x 100 mm Hex-Head bolts 10pcs</p> | <p>B</p>  <p>Ø1/4" x 13 mm Horizontal-Hole bolts 34pcs</p> | <p>C</p>  <p>Ø1/4" x 70 mm Hex-Head bolts 16pcs</p> |
| <p>D</p>  <p>Ø10 x 40 mm Wood dowel 4pcs</p> | <p>E</p>  <p>Stop Drawer-3pcs</p> | <p>F</p>  <p>M4 x 30 mm Wood Screws 28pcs</p> |
| <p>G</p>  <p>Ø1/4" x 35 mm Hex-Head bolts 4pcs</p> | <p>H</p>  <p>Ø1/4" x 15 mm Canopy head though - 4pcs</p> | <p>K</p>  <p>M4 x15 mm Wood Screws 20pcs</p> |
| <p>L</p>  <p>Steel Bracket -2pcs</p> | <p>M</p>  <p>Ø1/4" x 50 mm Hex-Head bolts 8pcs</p> | <p>N</p>  <p>Ø6 x 25 mm Wood dowel 16pcs</p> |
| <p>P</p>  <p>Wheels 8pcs (H=28mm)</p> | <p>Q</p>  <p>Allen Key 1pc</p> | |

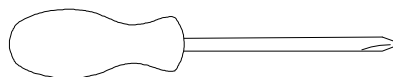



Assembly Tools Required (Not Included)

STEP 1: Following below illustration:

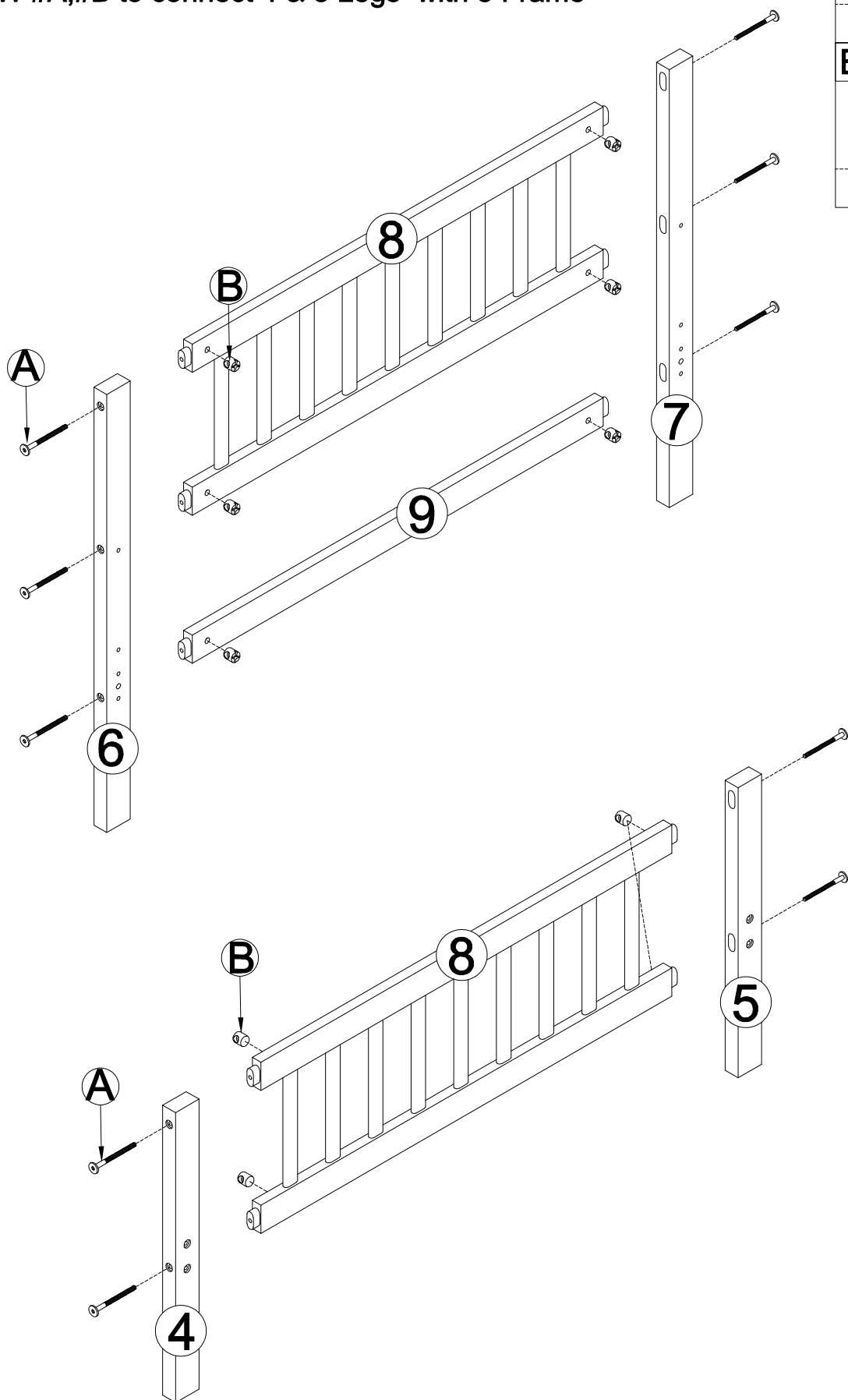
- Using HW #A,#B to connect 6 & 7 Legs with 8 Frame and 9 Wood Bar
- Using HW #A,#B to connect 4 & 5 Legs with 8 Frame

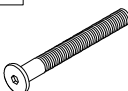





| | |
|----------|---|
| A |  |
| | 10pcs |
| B |  |
| | 10pcs |

STEP 2: Following below illustration:

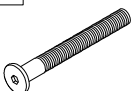



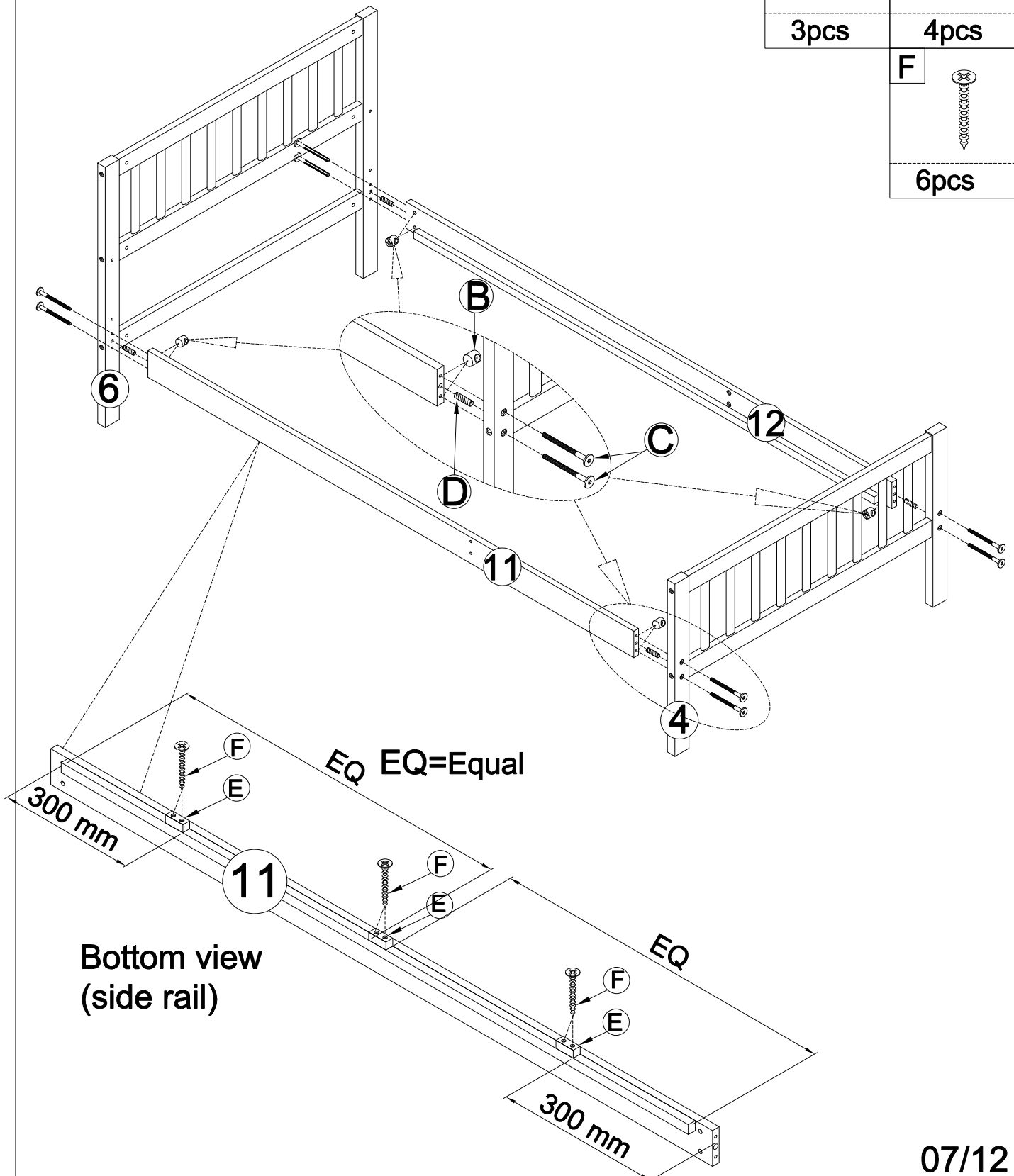

-Using HW #B,#C and Dowel D to connect 11 & 12 Side Rails with Frame (completed in step 1)

-Using HW #F to connect Stop Drawer E with 11 Side Rails

| | | | |
|----------|---|----------|---|
| B |  | C |  |
| | 8pcs | | 8pcs |
| E |  | D |  |
| | 3pcs | | 4pcs |
| | | F |  |
| | | | 6pcs |

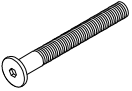

STEP 3: Following below illustration:

| | | |
|---|---|---|
| K  | B  | C  |
| 4pcs | 8pcs | 8pcs |
| L  | H  | G  |
| 2pcs | 4pcs | 4pcs |

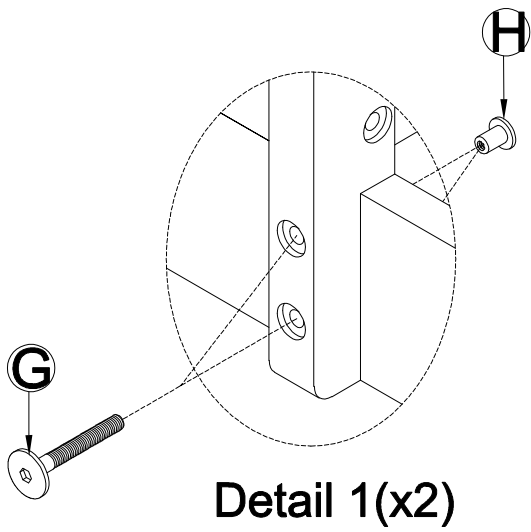
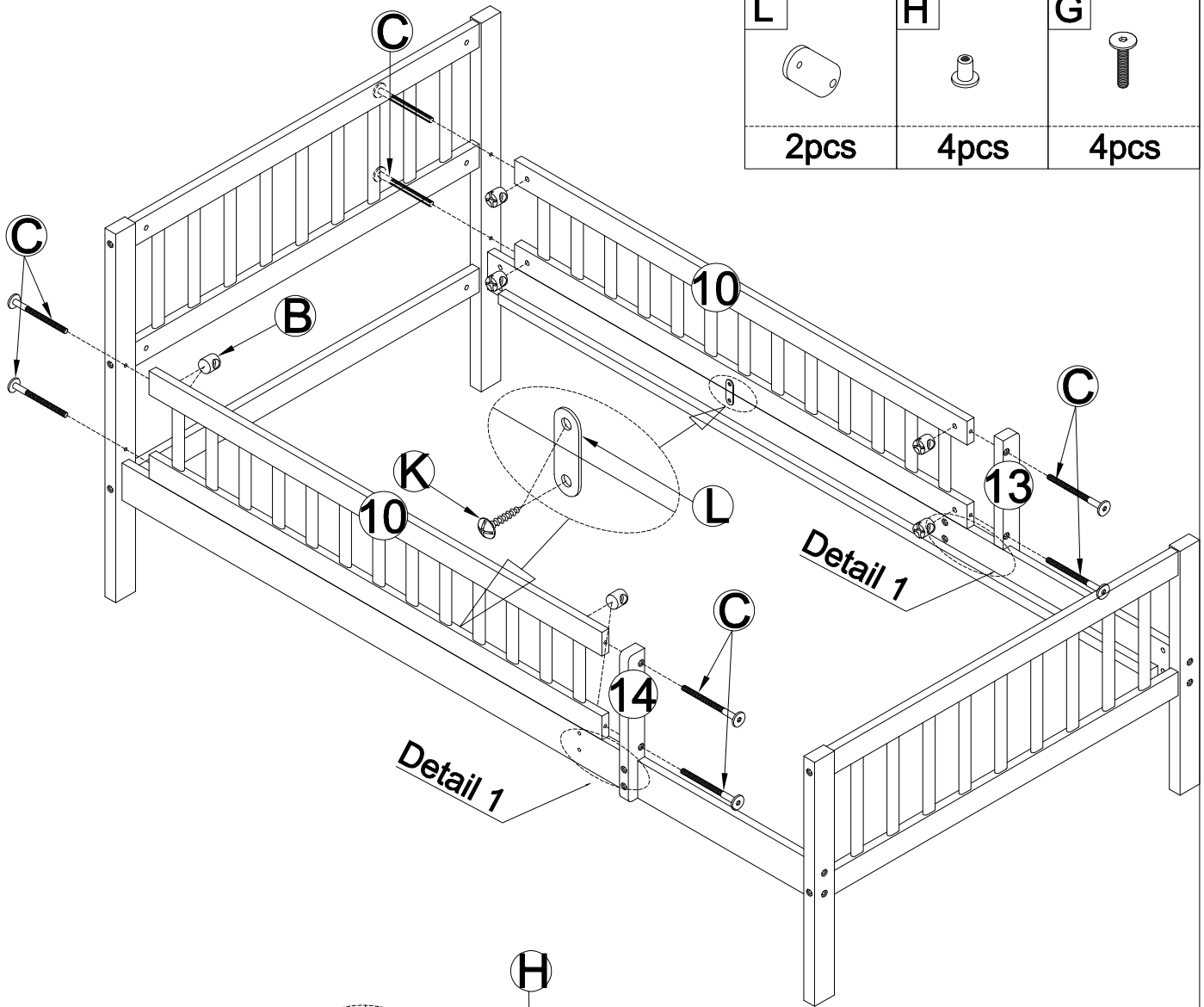

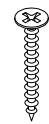

STEP 4: Following below illustration:

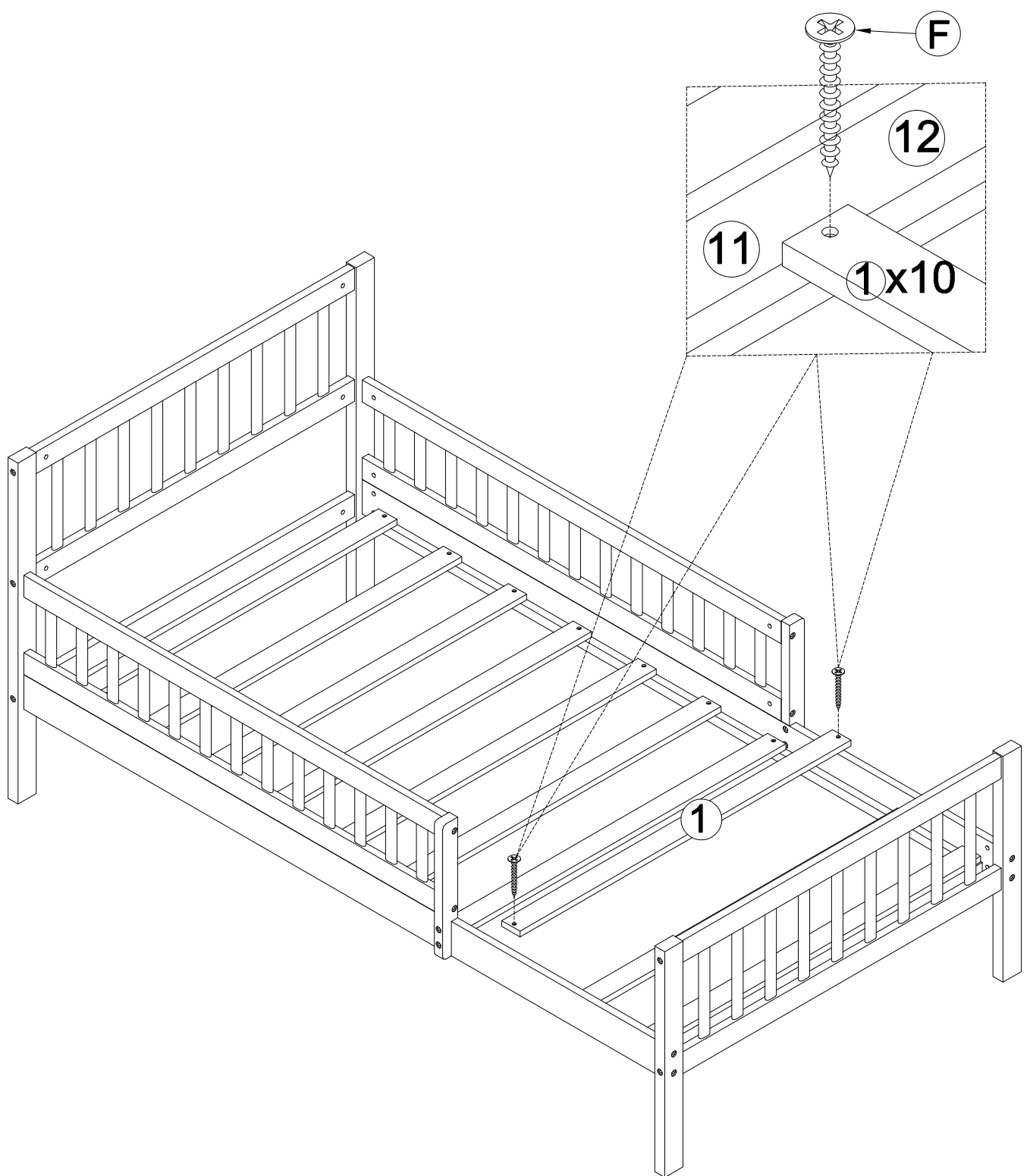
| | |
|--------------|---|
| F |  |
| 20pcs | |

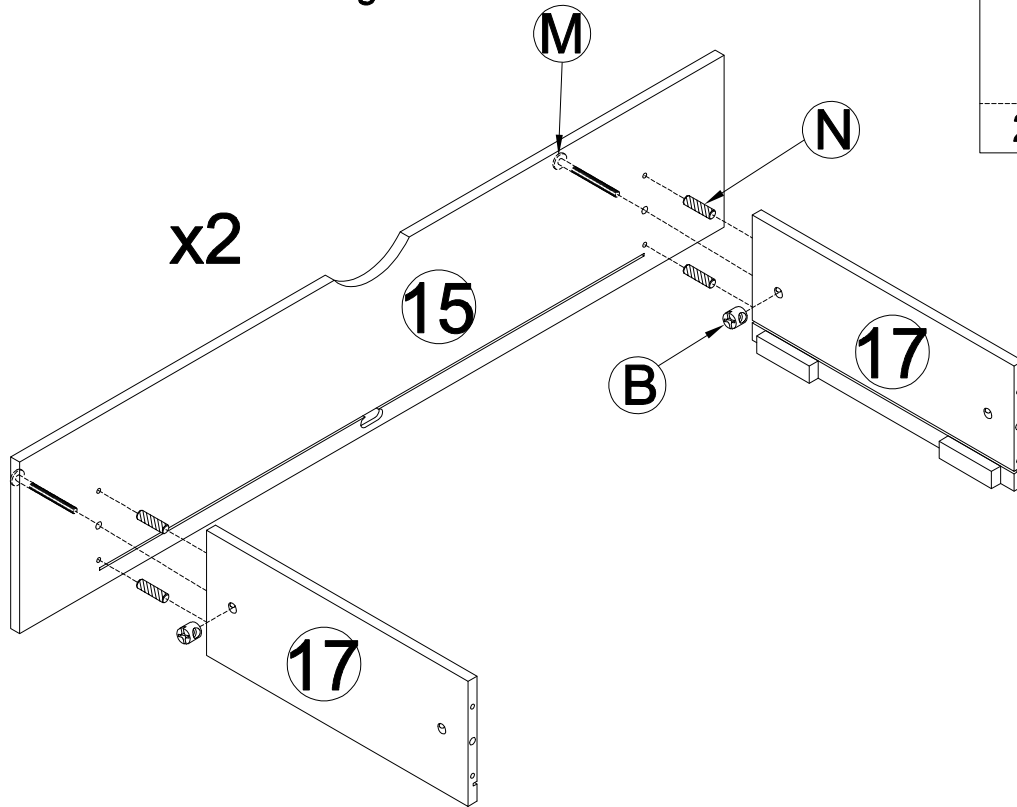

STEP 5-1: Following below illustration:

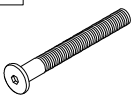
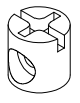

| | | | |
|--------|---|---|---|
| N |  | M |  |
| 2x4pcs | | 2x2pcs | |
| B | |  | |
| 2x2pcs | | | |

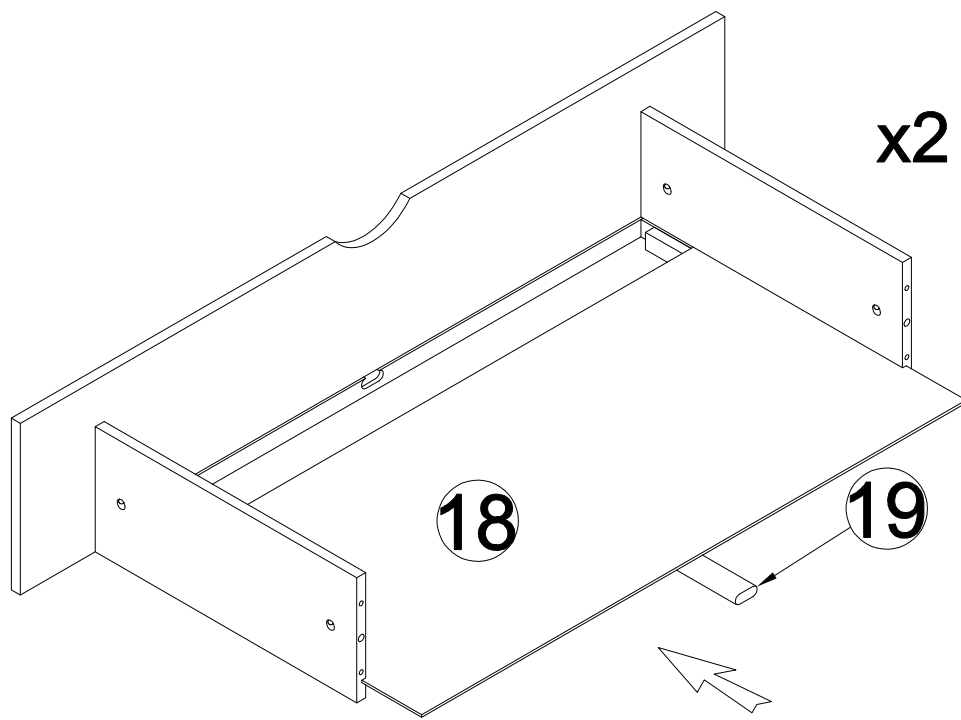

STEP 5-2: Following below illustration:

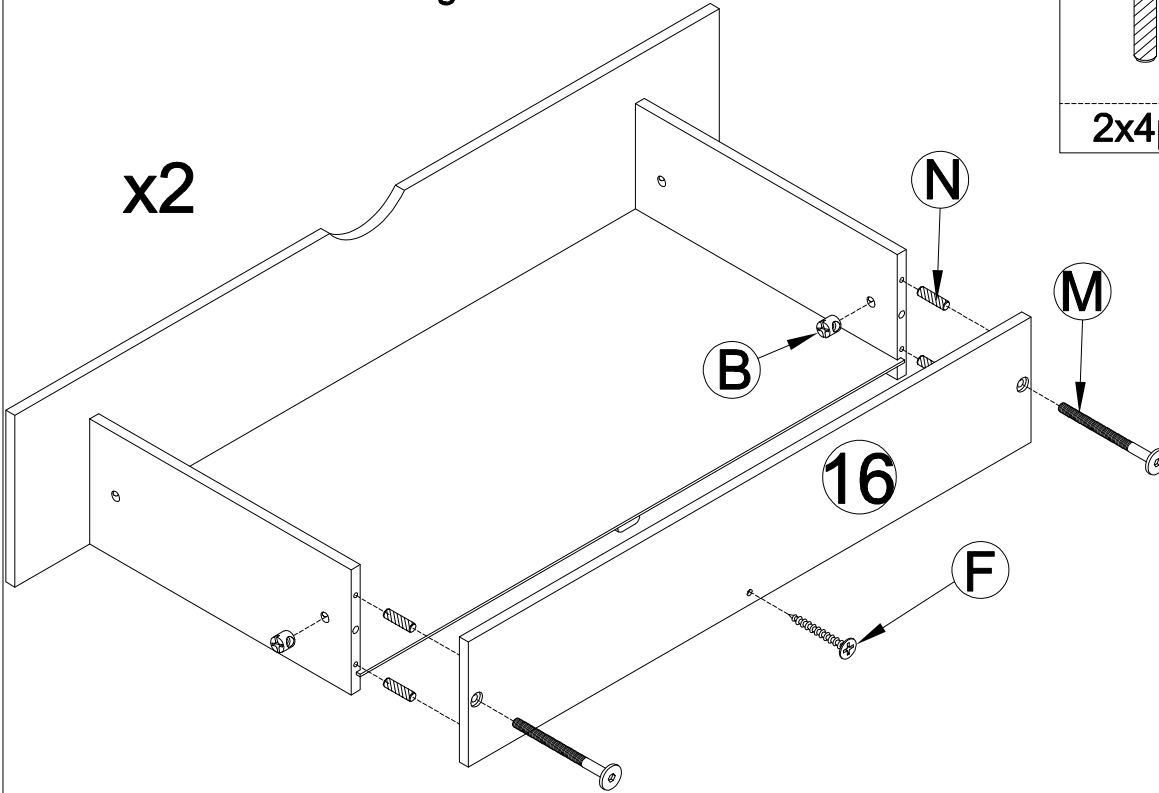

Push detail 19 in first and then
push detail 18 into position

STEP 5-3: Following below illustration:

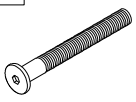

| | |
|---|---|
| N  | M  |
| 2x4pcs | 2x2pcs |
| B  | 2x2pcs |
| F  | 2x1pcs |

STEP 5-4: Following below illustration:

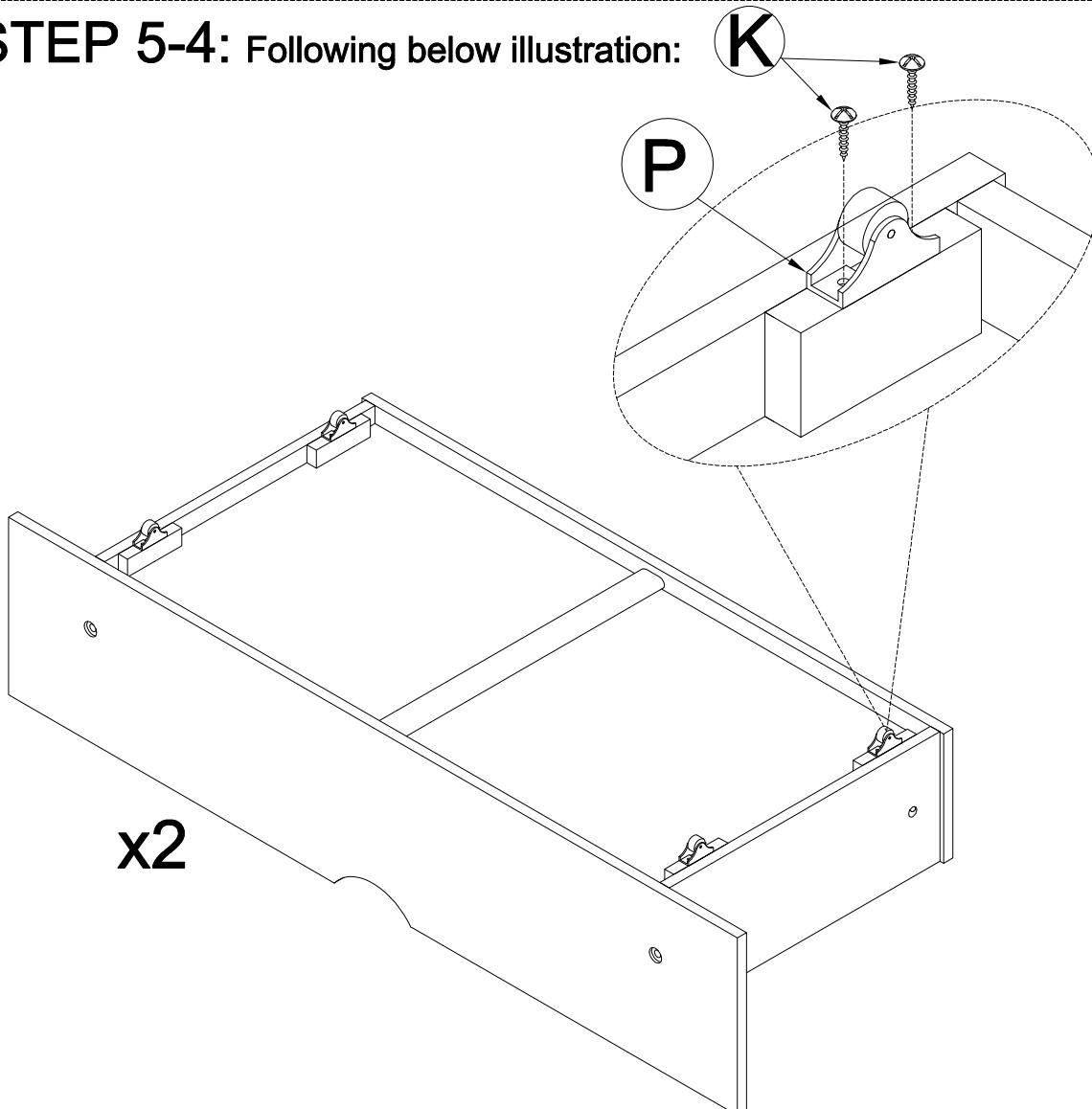

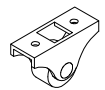
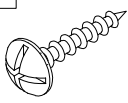
| | |
|---|---------------|
| P  | 2x4pcs |
| K  | 2x8pcs |

STEP 6: CONGRATULATION. YOU HAVE COMPLETED THE BED
Push 2 Drawers into position

