







ASSEMBLY INSTRUCTION GLIDER RECLINING LOVESEAT

NOTE: Do not use power tools for assembly. Power tools increase the risk of over tightening which lead to splitting or cracking the wood.

NO.	PART LIST	QTY	DESCRIPTION	NO.	PART LIST	QTY	DESCRIPTION
A		1	LEFT EAR	D		1	CONSOLE BACKREST
B		1	RIGHT EAR	E		1	RIGHT BACKREST
C		1	LEFT BACKREST	F		1	SEAT

STEP 1: Insert both ears to the back rest, align and insert female groove at the back onto the male brackets at the seat as shown in drawing.

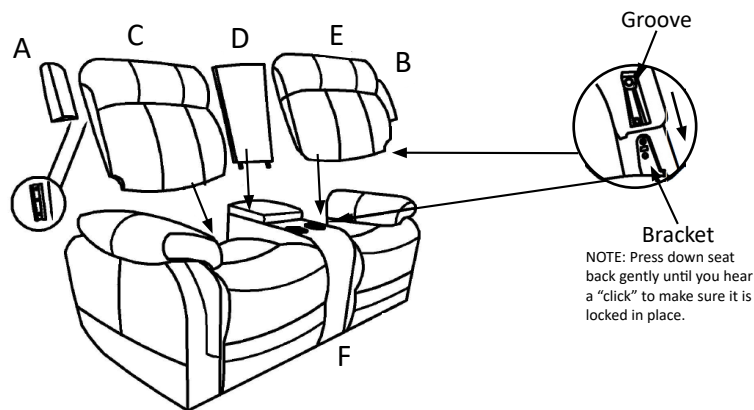

STEP 2: The loveseat is now ready. Enjoy!

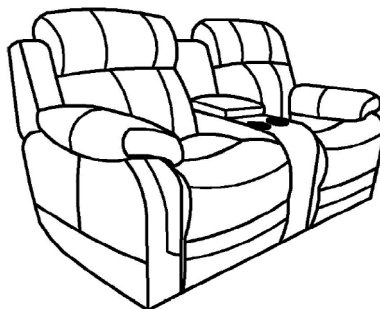







CARE INSTRUCTION FOR BONDED LEATHER FURNITURE

In order to maintain the original appearance of your upholstery furniture, please follow below simple care procedures:

- Avoid exposing furniture directly to sunlight or heating and air conditioning outlets. Exposure to sunlight or heating and air conditioning outlets will fade / damage bonded leather.
- Do not place your upholstery furniture too close to windows, radiators or vents and be sure to use windows treatments to block the sun's rays.
- Vacuum or wipe with a cloth regularly to remove dust.
- Blot (Do) all spills immediately with a clean, dry white cloth.
- Clean bonded leather with a damp cloth and mild soap and water. Do not use any abrasive or corrosive cleaners as they will damage the furniture.

ASSEMBLY INSTRUCTION RECLINING SOFA

NOTE: Do not use power tools for assembly. Power tools increase the risk of over tightening which lead to splitting or cracking the wood.

NO.	PART LIST	QTY	DESCRIPTION	NO.	PART LIST	QTY	DESCRIPTION
A		1	LEFT EAR	D		1	MIDDLE BACKREST
B		1	RIGHT EAR	E		1	RIGHT BACKREST
C		1	LEFT BACKREST	F		1	SEAT

STEP 1: Insert both ears to the back rest, align and insert female groove at the back onto the male brackets at the seat as shown in drawing.

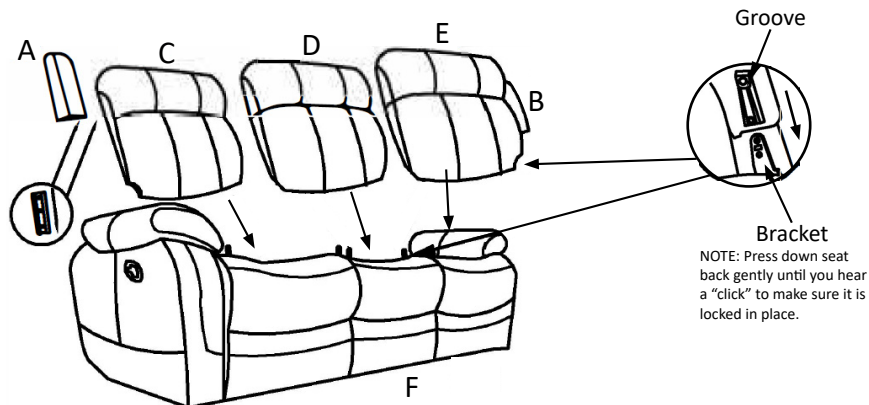

STEP 2: The sofa is now ready. Enjoy!

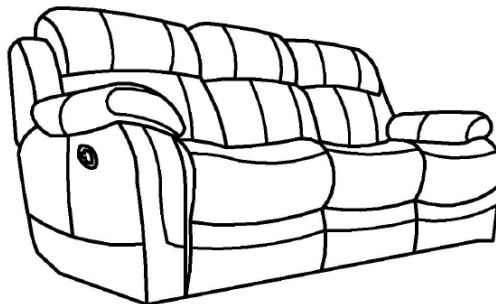

CARE INSTRUCTION FOR BONDED LEATHER FURNITURE

In order to maintain the original appearance of your upholstery furniture, please follow below simple care procedures:

- Avoid exposing furniture directly to sunlight or heating and air conditioning outlets. Exposure to sunlight or heating and air conditioning outlets will fade / damage bonded leather.
- Do not place your upholstery furniture too close to windows, radiators or vents and be sure to use windows treatments to block the sun's rays.
- Vacuum or wipe with a cloth regularly to remove dust.
- Blot (Do) all spills immediately with a clean, dry white cloth.
- Clean bonded leather with a damp cloth and mild soap and water. Do not use any abrasive or corrosive cleaners as they will damage the furniture.