

Assembly Instructions

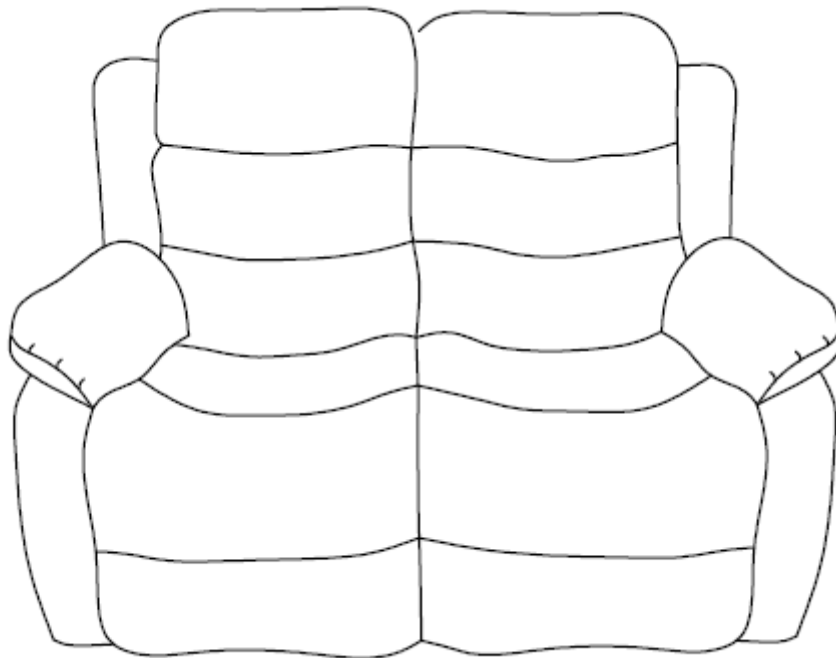

ASSEMBLY RATING

The Assembly Rating is a 5-point system that shows the degree of effort needed in assembling a specific product (with 1 being easy and 5 being difficult). For some products, two persons are recommended.

EASY  DIFFICULT

No Tools Required for Assembly



2 PERSONS RECOMMENDED

Thank you for your purchase!

We hope you will enjoy your new product for many years to come. Our commitment to providing quality products does not simply end when a purchase is made. We stand behind our products and will provide any support needed in order for you to fully enjoy your purchase. Your satisfaction is the greatest recognition we could have.

Because we value your trust in our company, we will do our best to meet your service expectations. Should you have any assembly related questions, parts replacement requests, comments or suggestions, please feel free to contact us any time. To help expedite the service, please have the assembly instructions available, along with your order receipt.



Due to the size and/or weight of this product, it is highly recommended that the assembly should be done near the area of its intended location. Make sure you have enough space to move around during the assembly. ALWAYS have at least two people to help with transporting and assembling the product to avoid any potential injury and/or damage.

MD

Parts List

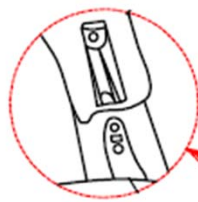
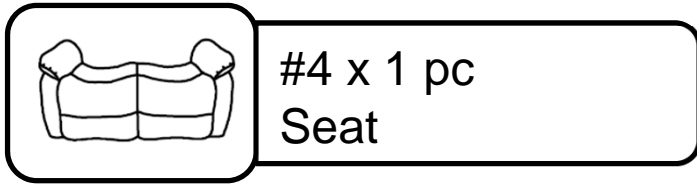
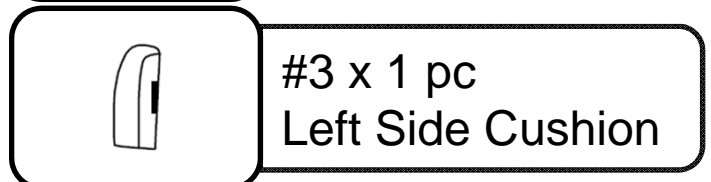
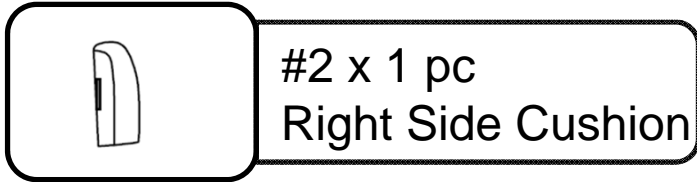
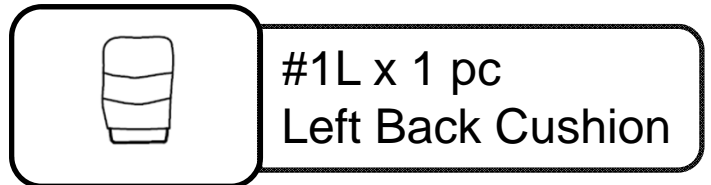
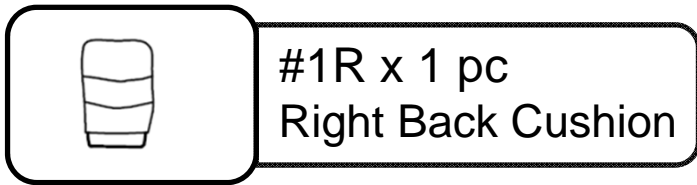

Assemble the right back cushion (#1R) and the left back cushion (#1L) onto the seat (#4) by aligning the brackets of the back cushions with the brackets of the seat (#4). Slide the brackets together until locked. Make sure all parts are firmly secured.

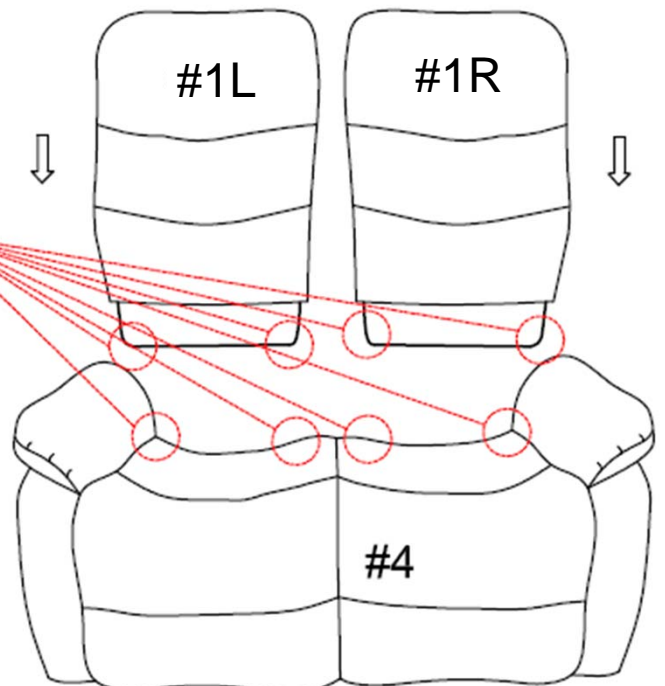

Note: Right and left are determined by facing the FRONT of the loveseat in the upright position.



Assemble the right side cushion (#2) by aligning the bracket of the right side cushion (#2) with the bracket of the right back cushion (#1R). Slide the brackets together until locked. Make sure all parts are firmly secured. Repeat the process to assemble the left side cushion (#3) onto the left back cushion (#1L).

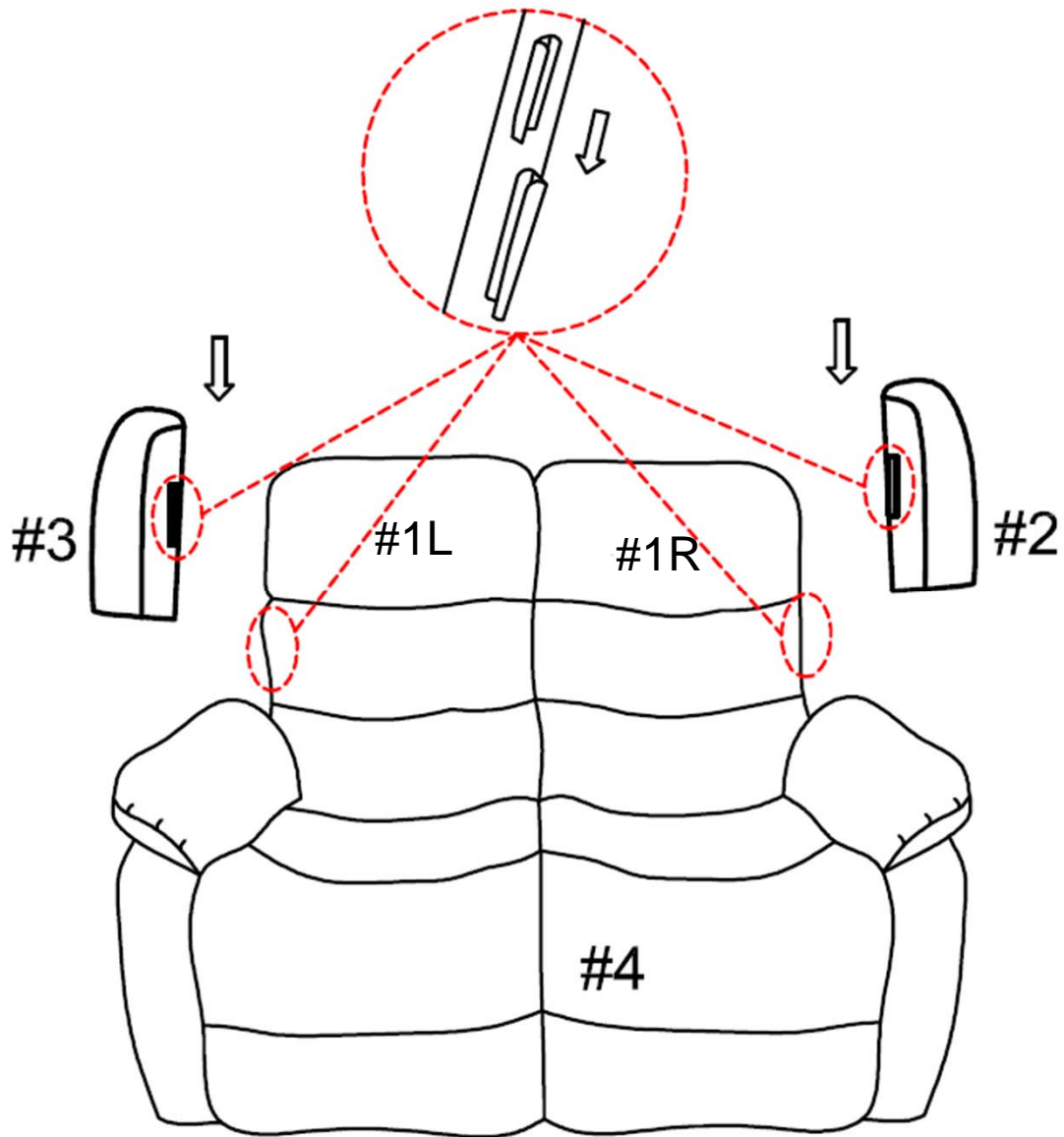

ASSEMBLY IS COMPLETED