

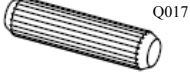

IMPORTANT

- Lire les instructions avant de commencer l'assemblage
- Identifier les pièces (chaque pièce est numérotée à une extrémité)
- S'assurer que les trous sont libres de poussière
- Vérifier que toute la quincaillerie est présente
- Tenir les pièces loin de la portée des enfants (pièces pointues)

IMPORTANT

- Read the instructions before starting assembly
- Identify parts (each piece is numbered at one end)
- Be sure holes are dust free
- Be sure that all hardware is present
- Keep away from children (sharp pieces)

A	 Q017	18X
---	--	-----

B	 Q055 1 1/8" T.R.W.	40X
---	---	-----

C		2X
---	---	----

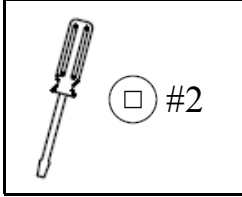

3

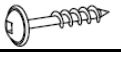
B		12X
---	---	-----

C		2X
---	---	----

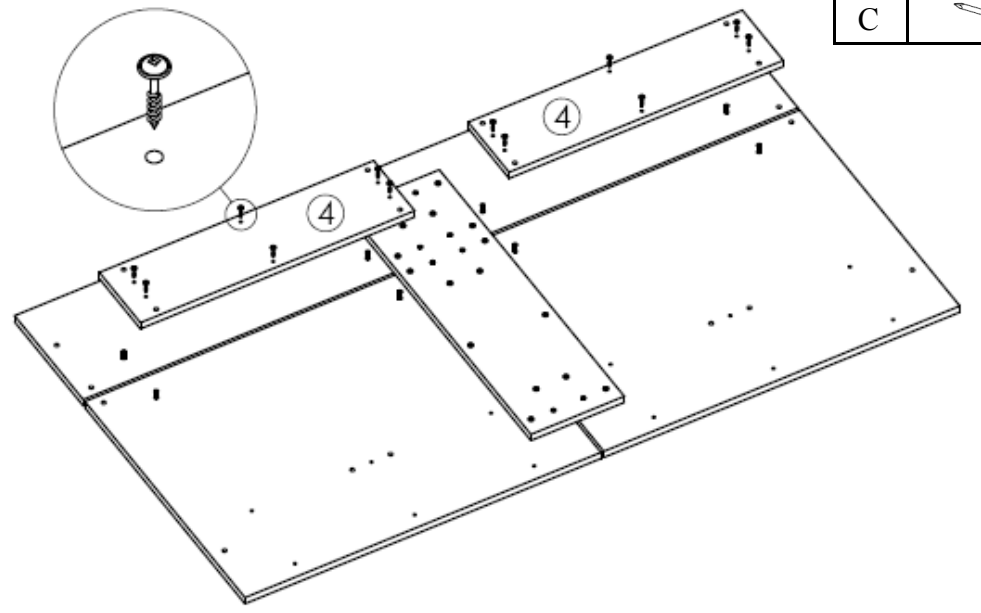

1

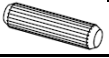
A		16X
---	---	-----

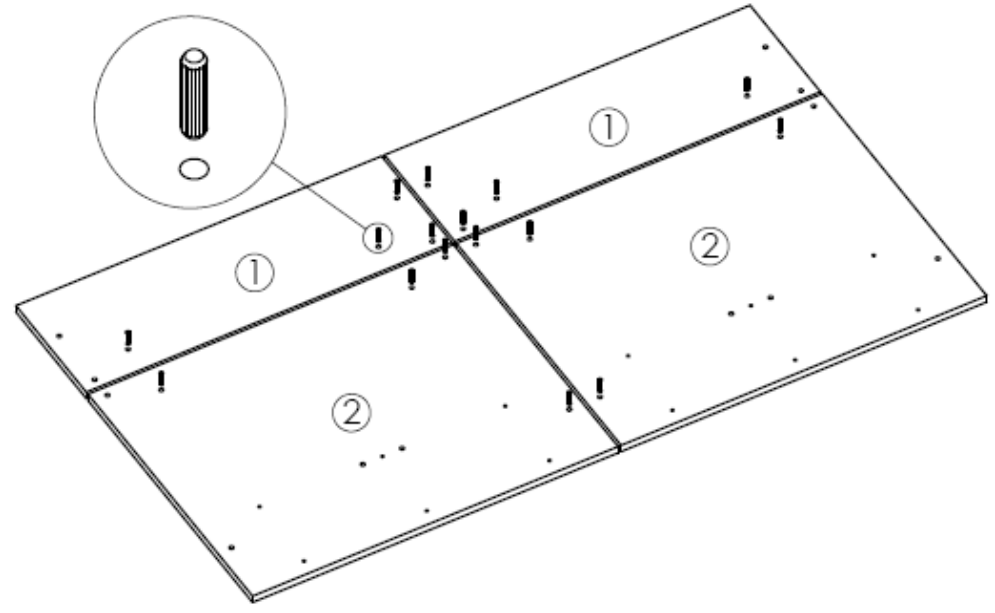

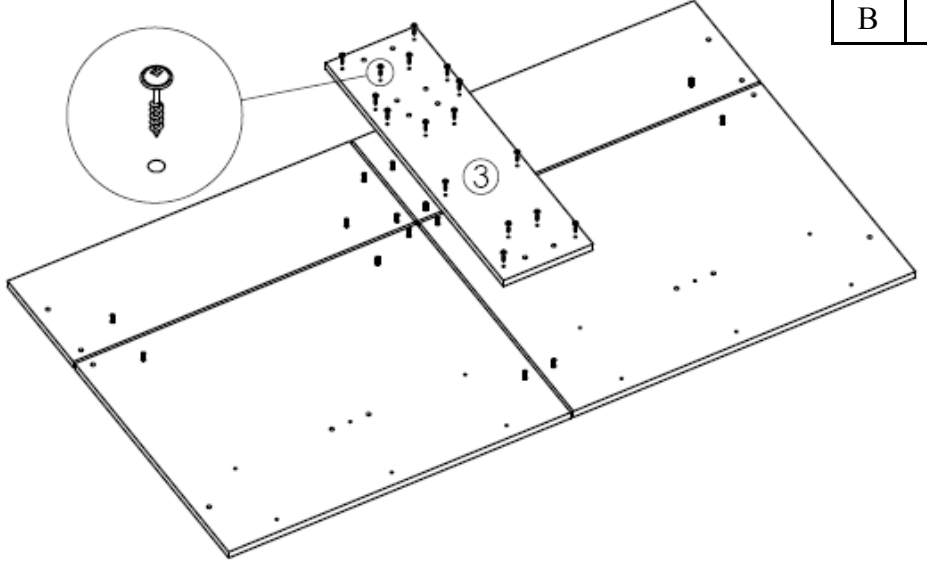

2

B		16X
---	---	-----

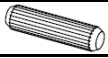

4

A		2X
---	---	----

B		12X
---	---	-----

