

Leave the dining chair in a shady outside for 1-2 days.

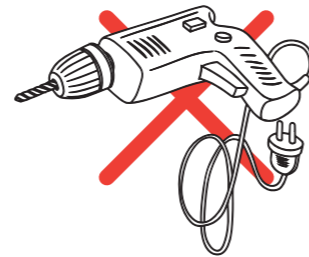

For longer use

Re-tighten bolts every 6 months by using the enclosed allen-key.
*Using an electric drill can damage the chair.
Please re-tighten bolts manually.

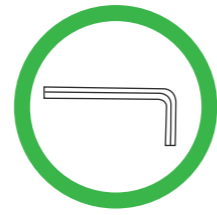

Safety Information



Sit in the center of the chair, with your back to the backrest



Do not sit at the front edge of the chair



Do not stand on the chair



Do not use the chair with more than one person



Do not push the chair around when a person is sitting in it



Do not push down on the backrest when a person is reclined



Do not place all your weight on only the backrest

INSTRUCTION MANUAL

INSTRUCTION MANUAL

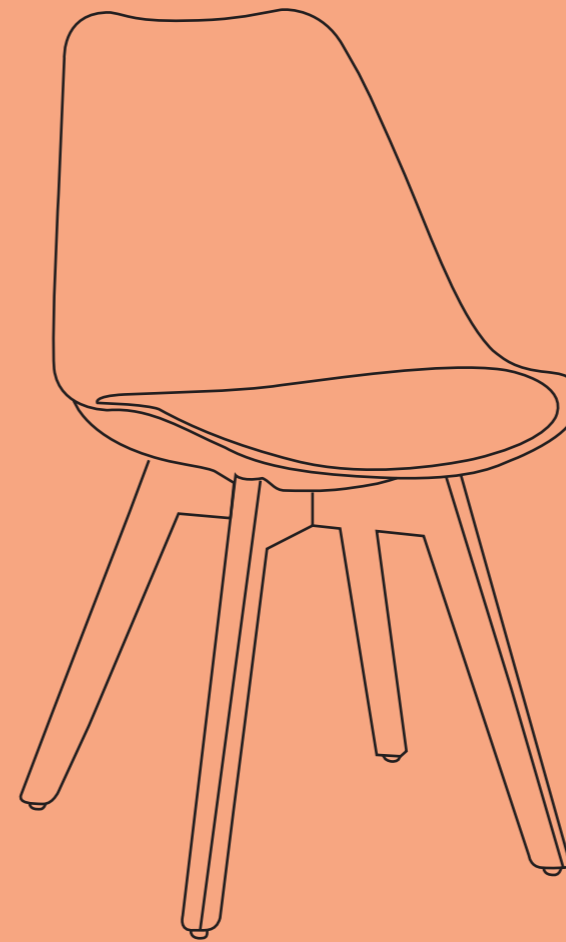

Package List

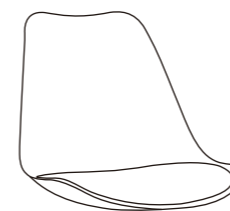

(A)*1

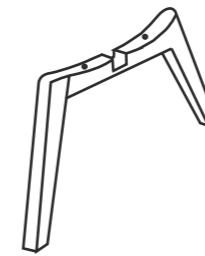

(B)*1

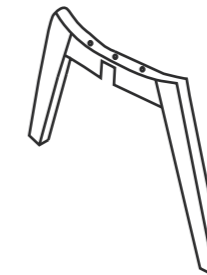

(C)*1

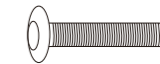

(D)*1



(E)*4



(F)*1



(G)*5

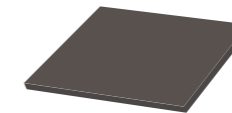

(H)*4

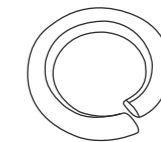

(I)*5

Assembly Instruction

1

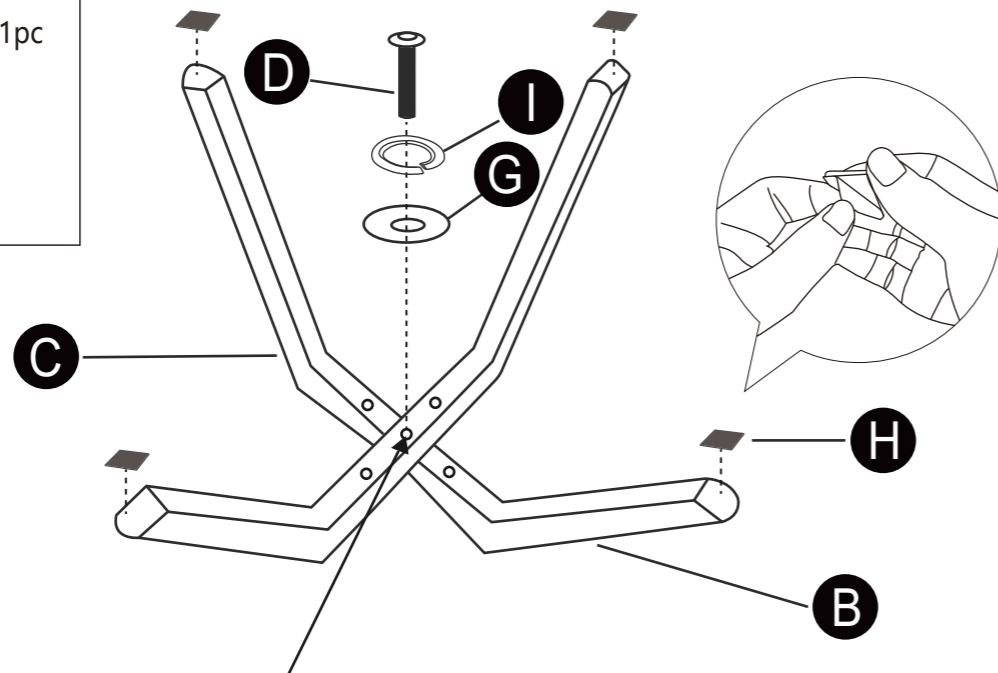
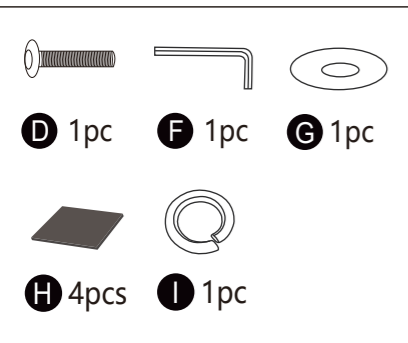
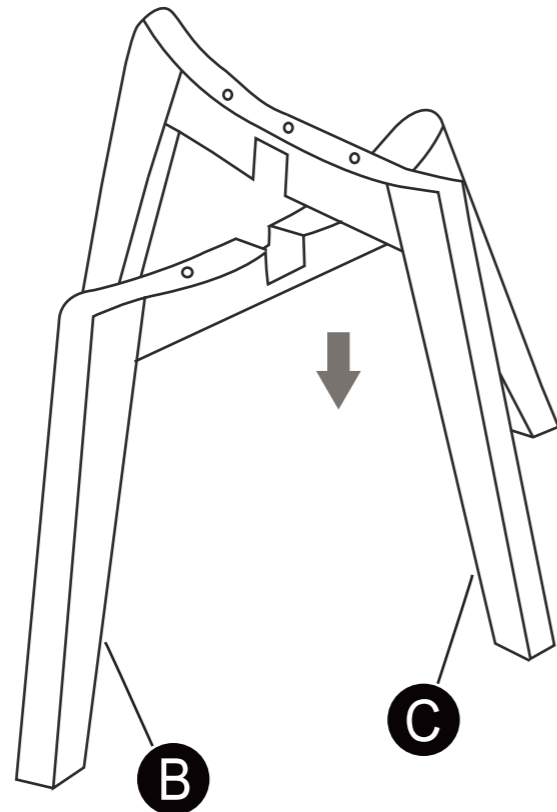

DO NOT TIGHTEN THIS SCREW TOO TIGHTLY

2

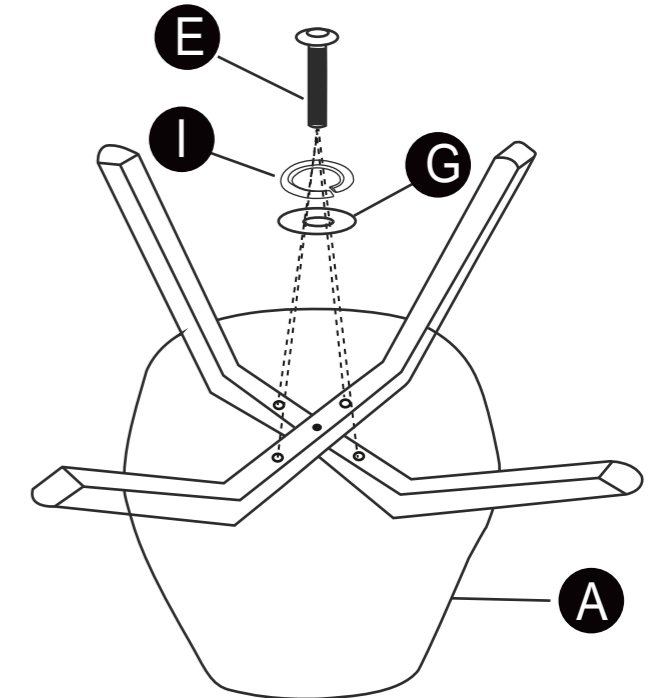
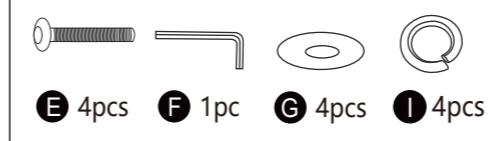

3

100% TIGHTEN ALL THE SCREWS

4

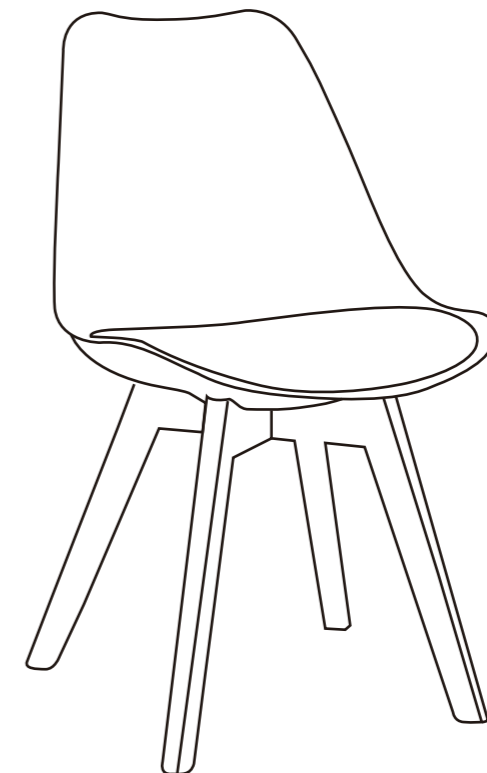

CAUTION:

* Make sure all bolts and screws are fully tightened before using chair. Lubricate all moving parts and tighten all bolts/screws every 6 months or whenever needed.