

31 LBS Outdoor Market Umbrella Base

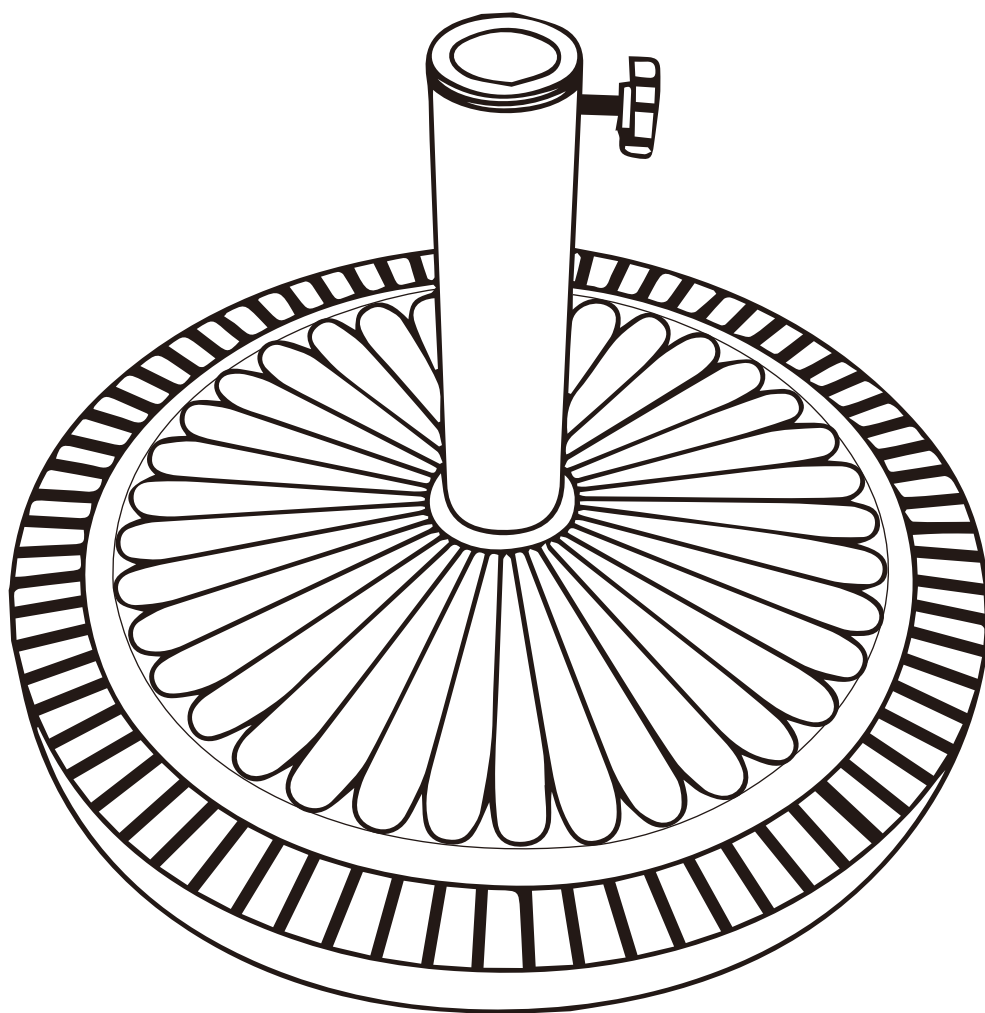

User Manual

Before you start

Warnings

IMPORTANT, RETAIN FOR FUTURE REFERENCE READ CAREFULLY

See enclosed instructions for assembly, safety and care information.

Failure to follow the warnings could result in serious injury.

Handle heavy parts with care.

Ensure that this product is fully assembled as illustrated before use.

This product should only be used on firm, level ground.

Keep small parts out of reach of children.

Do not stand or climb onto this product.

This product is intended for domestic use only.

Ensure the base is always placed on level ground.

Furniture can be dangerous if incorrectly used. No liability will be accepted for damage or injury caused by incorrect use of this product.

Please take care when handling or moving the base as careless handling may cause damage or injury.

A competent person should carry out assembly. No liability will be accepted for damage or injury caused by incorrectly installed or assembled product.

This product is HEAVY, it should be assembled as near as possible to the point of use. TAKE CARE WHEN LIFTING to avoid personal injury and (or) damage to the product.

Dos

When you are ready to start, make sure that you have the right tools, plenty of space and a clean, dry area for assembly.

Unwrap all packaging materials and place the components on suitable surface to prevent scratching your product.

Check the pack and make sure you have all of the parts listed.

Please check the pack contents before attempting to assemble this product. A full checklist of components is given in this leaflet. If any components are missing, please contact the retailer from whom you bought this product.

Check all screws and bolts are tightened and inspect regularly.

We recommend the use of furniture covers to protect your product when not in use.

To clean, wipe down with a sponge and warm soapy water and

wipe with a clean, dry cloth.

Please take care during use to avoid the possibility of pinching or trapping fingers.

To maintain the look of the base, clean periodically with a damp lint-free cloth and a little mildly soapy water. Do not use furniture polish or abrasive cleaning products or those containing silicone.

From time to time lubricate the locking bolt with a little grease or petroleum jelly.

Regularly check the stability of your parasol. Take care when lifting the base due to the heavy nature of this item.

Don'ts

Do not stand or climb onto the product.

Do not use power tools to construct this product.

Do not use this product if parts are missing, damaged or worn.

Never use scourers, abrasives or chemical cleaner.

Never drag furniture when moving it, always lift it.

This base is made of polyresin/concrete. Do not drop it at any time as it may cause it to shatter.

Do not use in high winds.

Number of people required for assembly

Two people



Time to assemble









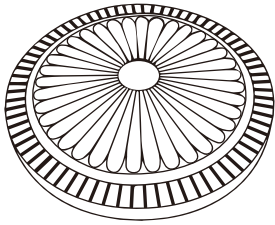

5 Minutes

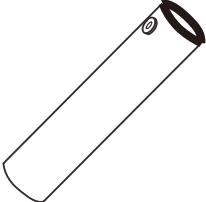
Tools required

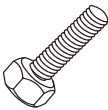
Spanner, not provided.

Parts List

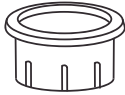
| Part No. | Diagram | Qty. | Part No. | Diagram | Qty. |
|------------|---|-------------|------------|--|-------------|
| A |  Base | 1 PC | B |  Decorative Ring | 1 PC |
| C |  Base Tube | 1 PC | D |  Adjustable Bolt | 1 PC |
| E |  Bolt | 1 PC | F |  Spring Washer | 1 PC |
| G |  Flat Washer | 1 PC | H35 |  35mm Adaptor | 1 PC |
| H38 |  38mm Adaptor | 1 PC | H48 |  48mm Adaptor | 1 PC |

Step One

Select and Insert suitable Adaptor (H35 or H38 or H48) into the top end of the Base Tube (C)

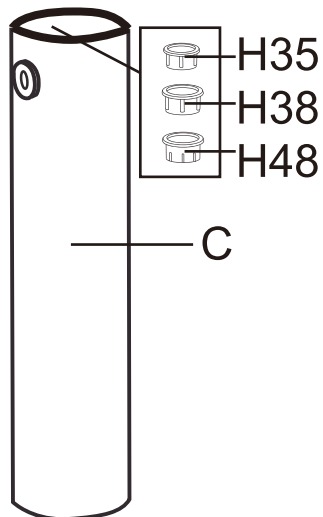

Step Two

Screw the Adjustable Bolt into the Base Tube (C).

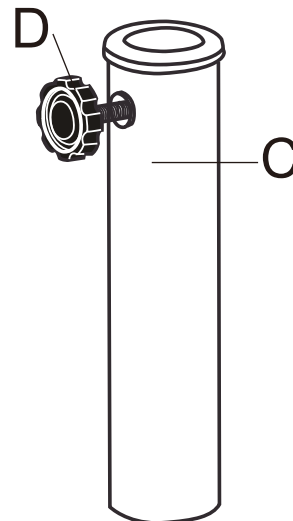

Step Three

Assemble the Base Tube (C) to the Base (A) using Decorative Ring (B), Bolt (E), Spring Washer (F) and Flat Washer (G).

Your parasol base is now ready for use.

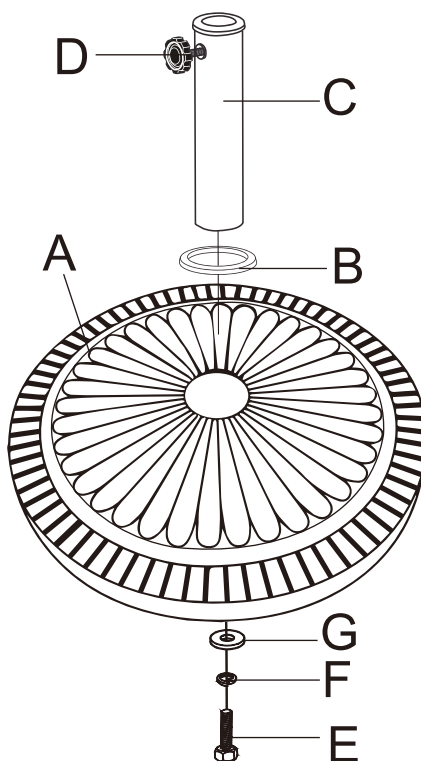

Step Four

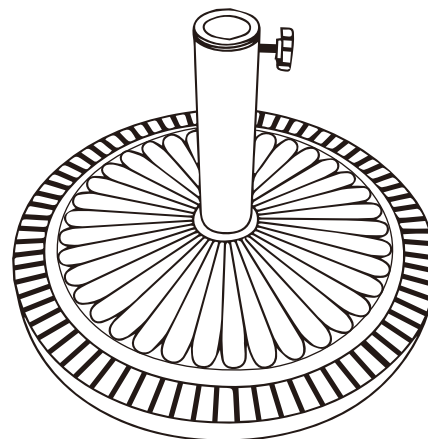

PLEASE KEEP THESE INSTRUCTIONS FOR FUTURE REFERENCE