

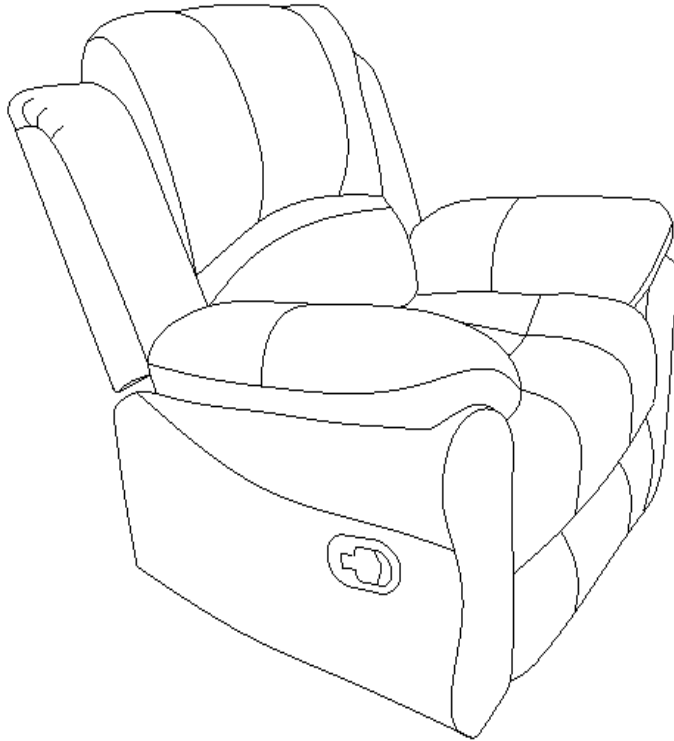

Assembly Instructions

Caution : You must read this before you proceed

RECLINING CHAIR

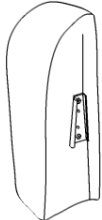

Parts List

Label	Picture	Description	QTY
A		Chair Backrest	1
B		Left Wing	1

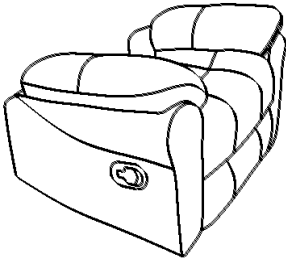
C		Right Wing	1
D		Chair Base With Footrest	1

Assembly Preparation

Before Beginning Assembly:

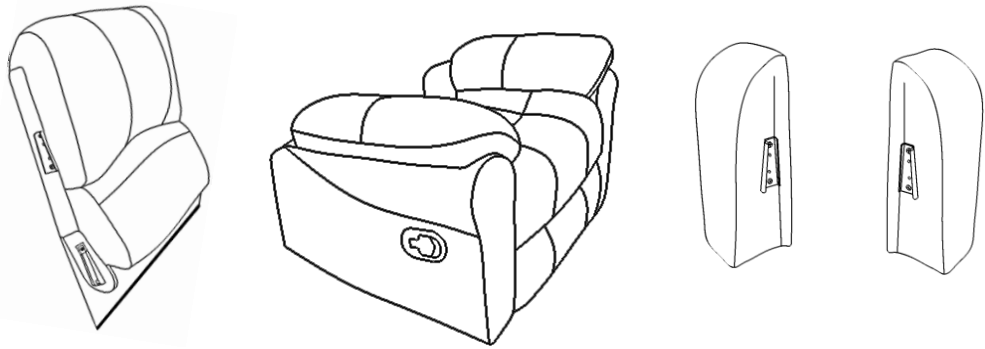

- Read instructions, cover to cover-



- Have 2 adults on hand for assembly-



- Do not assemble on flooring or carpet-



- Assemble on a clean non-marring surface (packing foam)-



- Save all packaging until finished-

Assembly Steps

Overview

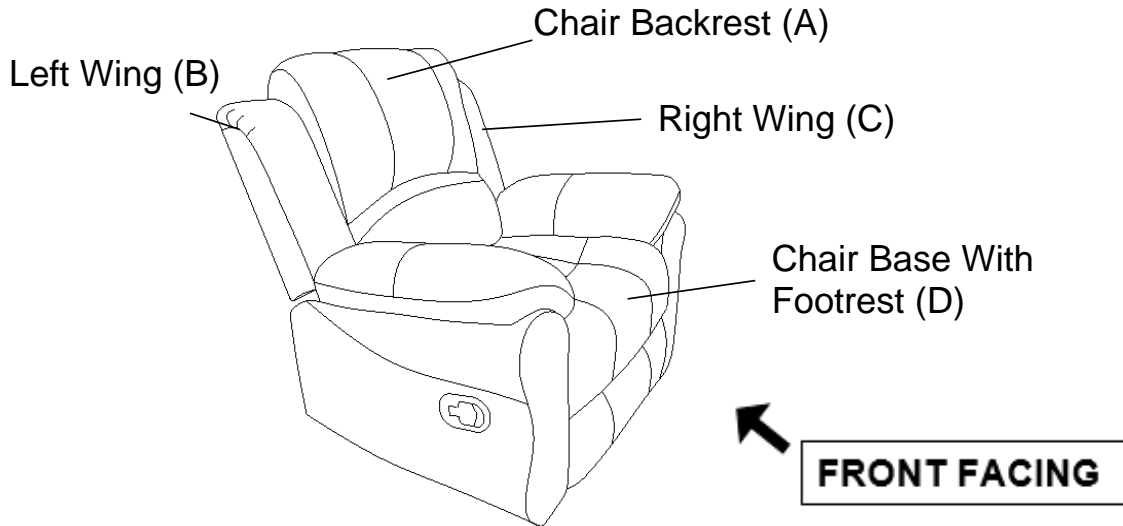

This Reclining Chair has multiple parts and may require up to 30 minutes to assemble. To give you an overview of the Reclining Chair parts, the above picture is to help you put the various parts into perspective. Please read through the instructions below to familiarise yourself with the parts and steps before assembly.

Step 1

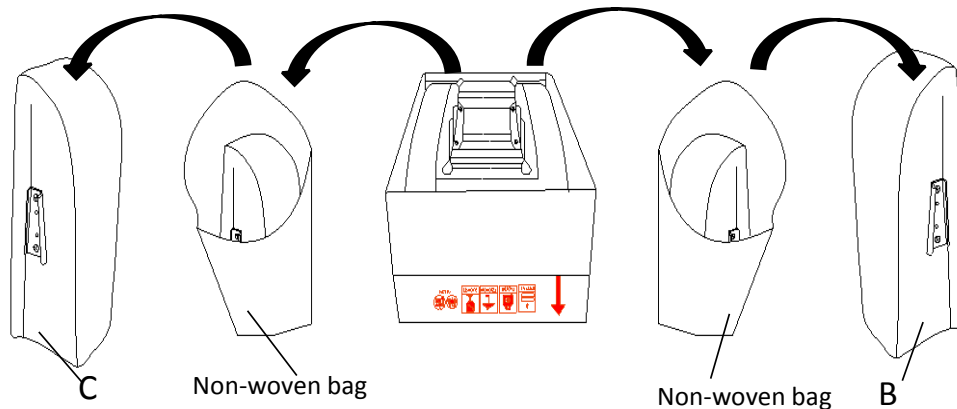

Take out the two non-woven bags with the Left Wing(B) and Right Wing(C) inside from the bottom of the armrest.
Then take out the Wings from non-woven bags.

Step 2

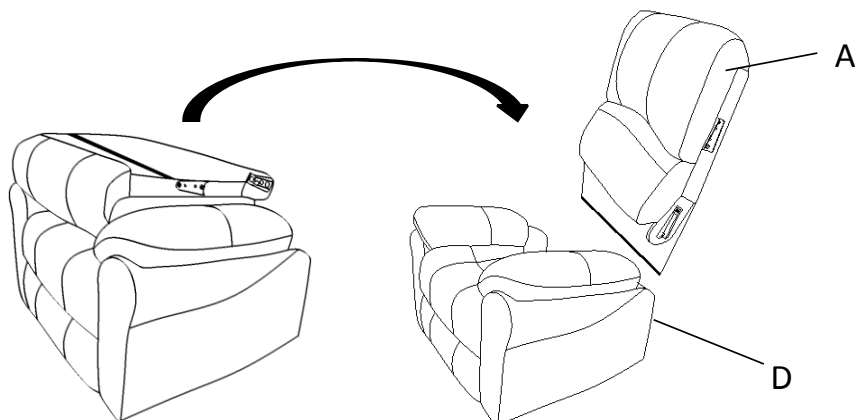

Remove the Chair Backrest(A) from the Chair Base with Footrest(D).

Step 3

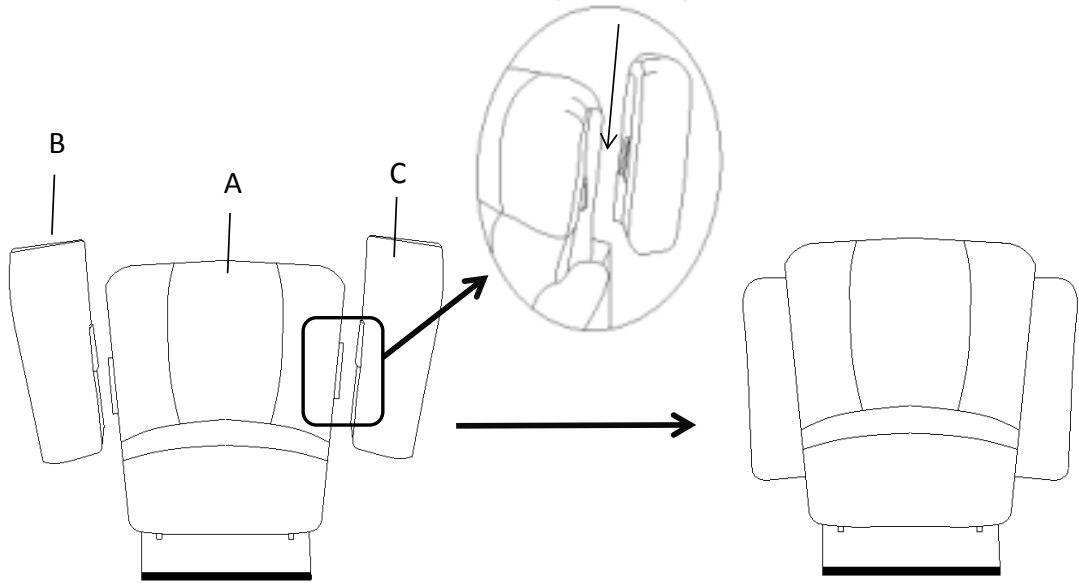

Position the Chair Backrest(A) on it's right side.
Align the mounting brackets of the Left Wing(B) with those on the left side of Chair Backrest(A).
Then slide Left Wing(B) forward by hand to make sure it locks into the position as shown in the picture.
Repeat the same process to attach Right Wing(C) to the right side of Chair Backrest(A).

Step 4

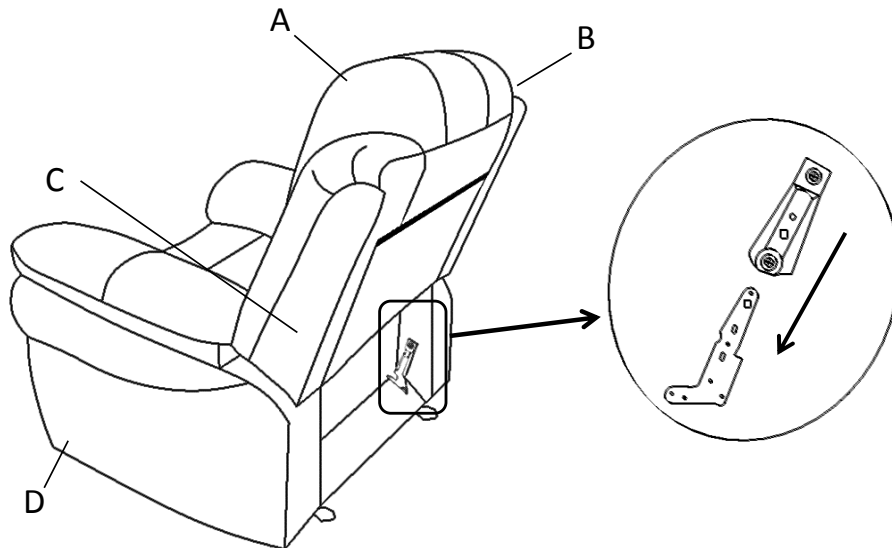

With assistance from an adult partner, hold up the fully assembled Chair Backrest(A) with Wings, and stand behind the Chair Base with Footrest(D).
Insert the small metal arms on the sides of the Chair Backrest(A) into the prefabricated slide lock gadget on the Chair Base with Footrest(D) as shown above.
Firmly but gently, push the Chair Backrest(A) downwards until it is fully slotted and locked into position.

Step 5



Smooth down the fabric flap on the Chair Backrest(A).
Run your hands down both sides of the flap, from top to bottom, allowing the velcro tape to adhere to the flap under the seat of the chair.

Step 6

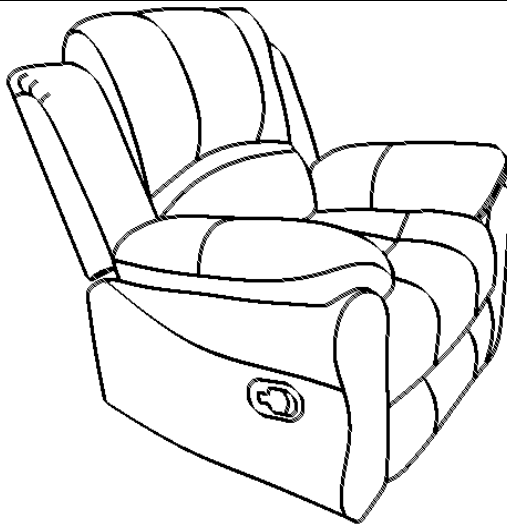

Your Reclining Chair is ready for use.
This Reclining Chair can only be used on a flat, level surfaces.

Warning

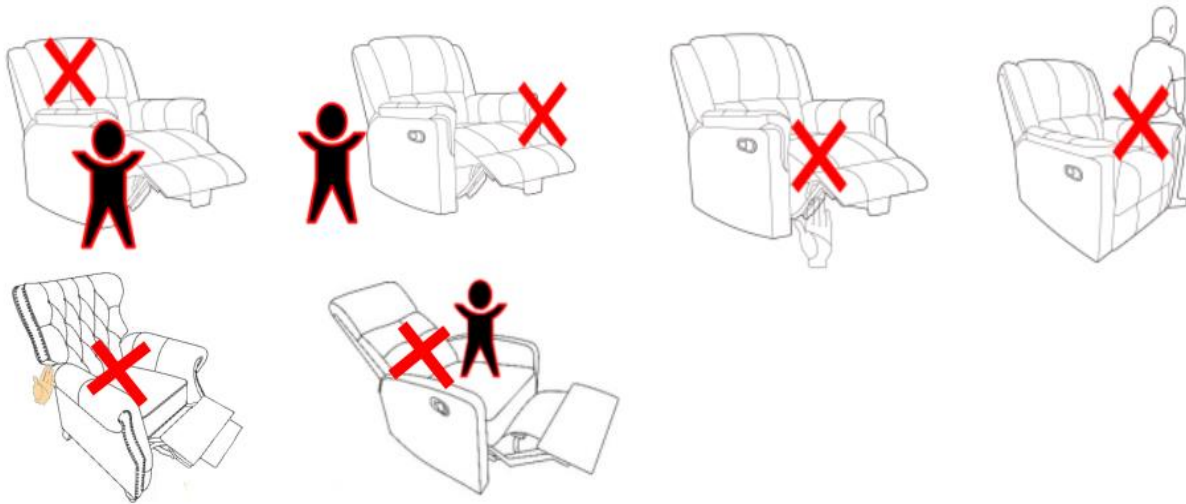

Keep hands and feet clear of the footrest mechanism and any gaps.
Do not allow children to play on the chair.
Always leave the chair in an upright and closed position after use.
Do not sit on the arms of the recliner.
Do not stand up on the recliner.
Only the occupant should operate the chair.

User Instructions

Reclining Chair

Please read the Instruction Manual below carefully before use.

This is a Reclining Chair. At anytime in a reclined seat position or in the upright position. You may enjoy the rocking motion by using your body weight in a back-front rocking motion, and also the swivel motion.

Supervise children, when in use of this Recliner.

To recline backrest:

Sit into the seat.
Open the trigger on the outside of right armrest.
Use your body weight and push backwards into the backrest, until you reach your desired, reclined position.

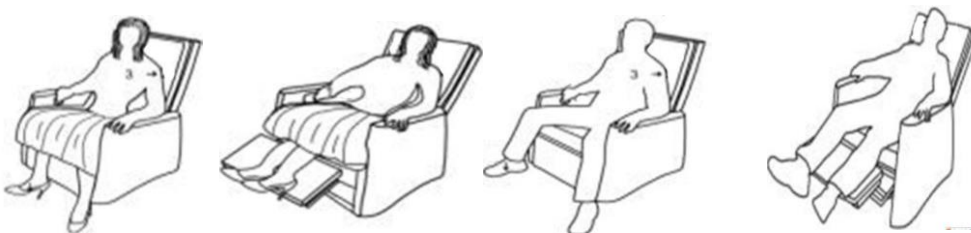

To get out of chair - move Seatback into upright position

Tilt your body weight slightly forward and upwards.
The seat back will come up to an upright position.
Use your feet to push the footrest back. You can stand up when the footrest and the mechanism click.

Where necessary, use your arms to help lift - push yourself out of the seat.

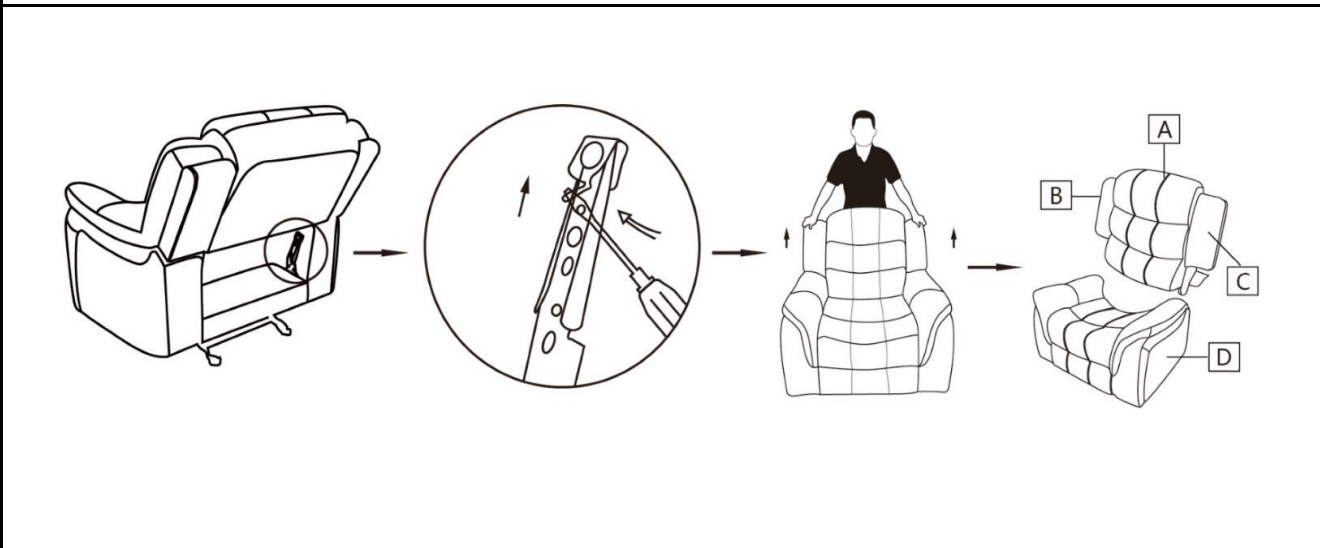
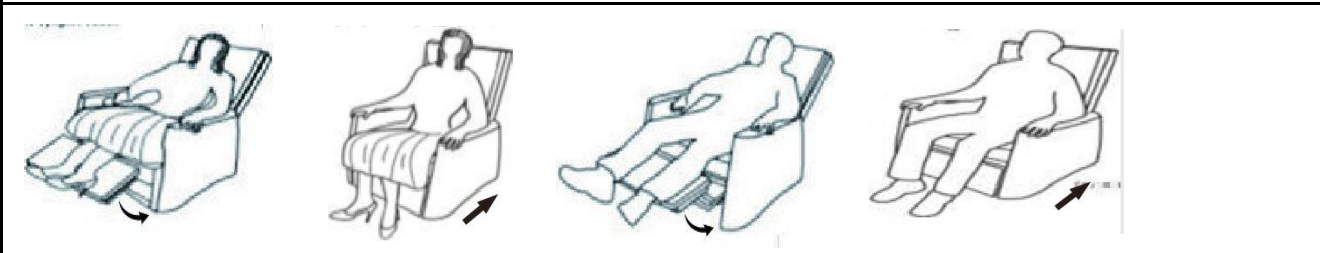

To Disassemble:

Open the flap on the Chair Backrest(A).





















Use a screwdriver (Don't use fingers) to press the metal ear on the preattached Metal Bracket outward;

At the same time pull the Chair Backrest(A) upward while your adult partner steadies the Chair Base(D).

Repeat the same step for another side.

Then the Chair Backrest(A) can be taken out.

Care & Maintenance

-   ● Do not put hot items directly on furniture surface
 -   ● Do not clean furniture with harsh cleansers or polish.
 -   ● Do not place furniture under direct sunlight.
 -   ● Do not place furniture near heating or cooling vents.
 -   ● Do not write on furniture without a padded barrier to protect the surface.
 -   ● Do not place furniture outside . For indoor use only .
 -   ● Not for commercial use. For residential use only .
 -   ● Stains may be removed with mild soap solution and damp cloth.
 -   ● Children should not climb or jump on the furniture.
-
-   ● Dust and pick-up spills using a clean, non-colored, lint-free cloth .

Questions & Answers about Proposition 65

• What is Proposition 65?

Proposition 65 requires businesses to provide warnings to Californians about significant exposures to chemicals that cause cancer, birth defects or other reproductive harm. These chemicals can be in the products that Californians purchase, in their homes or workplaces, or that are released into the environment. By requiring that this information be provided, Proposition 65 enables Californians to make informed decisions about their exposures to these chemicals.

Proposition 65 also prohibits California businesses from knowingly discharging significant amounts of listed chemicals into sources of drinking water.

Proposition 65 requires California to publish a list of chemicals known to cause cancer, birth defects or other reproductive harm. This list, which must be updated at least once a year, has grown to include approximately 900 chemicals since it was first published in 1987.

• What types of chemicals are on the Proposition 65 list?

The list contains a wide range of naturally occurring and synthetic chemicals that include additives or ingredients in pesticides, common household products, food, drugs, dyes, or solvents. Listed chemicals may also be used in manufacturing and construction, or they may be byproducts of chemical processes, such as motor vehicle

• What does a warning mean?

If a warning is placed on a product label or posted or distributed at a workplace, a business, or in rental housing, the business issuing the warning is aware or believes that it is exposing individuals to one or more listed chemicals.

By law, a warning must be given for listed chemicals unless the exposure is low enough to pose no significant risk of cancer or is significantly below levels observed to cause birth defects or other reproductive harm.

• Where can I get more information on Proposition 65?

If you have specific questions on the administration or implementation of Proposition 65, you can contact OEHHA's Proposition 65 program at P65.Questions@oehha.ca.gov, or by phone at (916) 445-6900.