

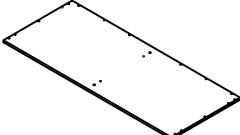

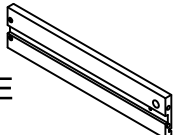

ASSEMBLY INSTRUCTION

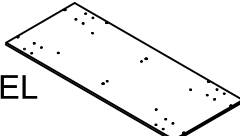

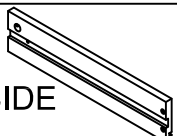
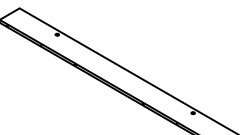
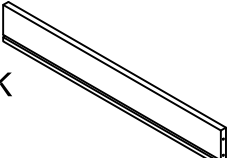
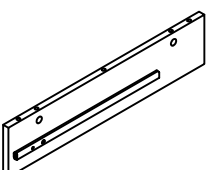
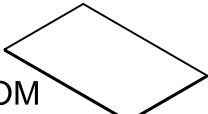
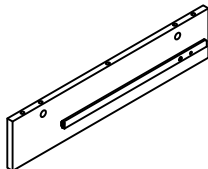
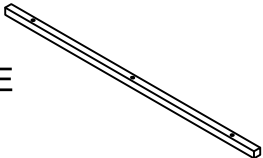
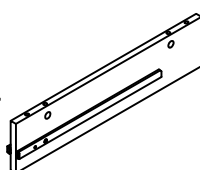
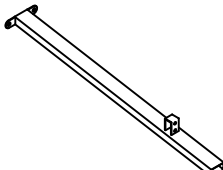

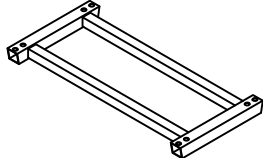

Thank you for purchasing the quality product. Be sure to check all packing material carefully for small parts which may have come loose inside the cation during shipment. Separate, identify and count all parts and metal hardware. Compare with all parts list to be sure all parts are present. If any part(s) are missing or damaged, please contact your local furniture dealer. For efficient and speedy service, please indicate the model number and code letter of part(s) needed.

*** Do not fully tighten screws until fully assembled ***

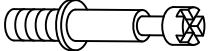
COMPONENT PARTS

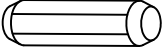
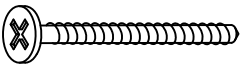
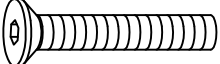
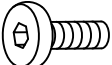
DESCRIPTION	PART NAME	QTY (PCS)	DESCRIPTION	PART NAME	QTY (PCS)
①	TOP PANEL 	1	⑨	LEFT DRAWER SIDE 	2
②	BOTTOM PANEL 	1	⑩	RIGHT DRAWER SIDE 	2
③	BACK PANEL 	1	⑪	DRAWER BACK 	2
④	LEFT PANEL 	1	⑫	DRAWER BOTTOM 	2
⑤	RIGHT PANEL 	1	⑬	CROSS TUBE 	2
⑥	CENTER PANEL 	1	⑭	LEG FRAME 	8
⑦	LEFT DRAWER FACE 	1	⑮	II -FRAME 	2
⑧	RIGHT DRAWER FACE 	1			

HARDWARE REQUIRED

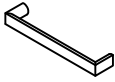
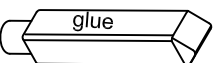
(A)		ALLEN KEY		1 PC
(B)		CAM BOLT	34.8mm	12 PCS
(C)		CAM LOCK		12 PCS
(D)		WOODEN DOWEL	φ8mm*30mm	28 PCS
(E)		SCREW	8#*38mm	16 PCS
(F)		BOLT	φ1/4"*38mm	6 PCS
(G)		BOLT	φ1/4"*19mm	32 PCS
(H)		BOLT	φ5/32"*12mm	4 PCS
(I)		BOLT	8#*32mm	4 PCS
(J)		WASHER	φ16mm	16 PCS
(K)		PLUG	20mm*40mm	8 PCS
(L)		KNOB		2 PCS
(M)		GLUE		1 PC

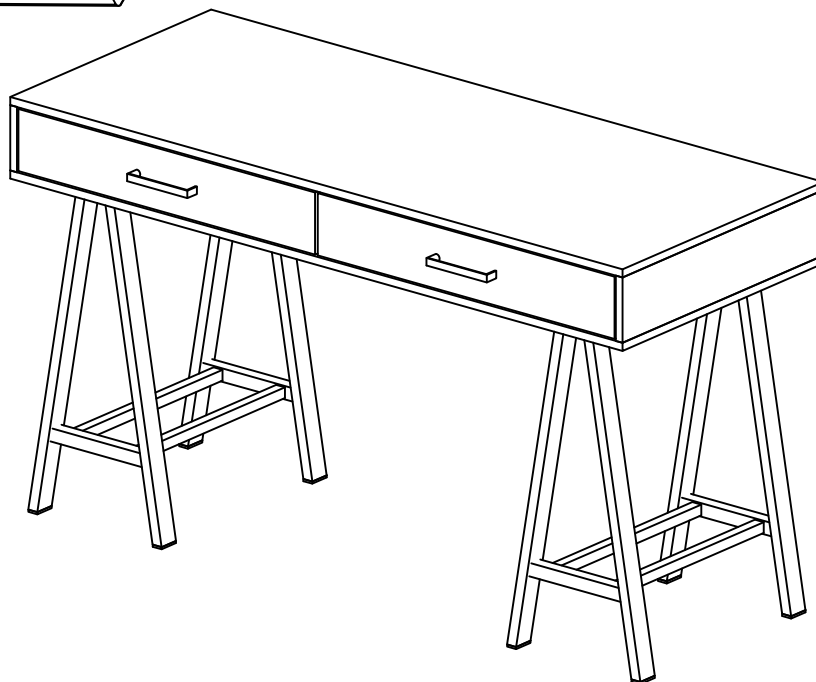

Attention

*** Assembly required: 2-people recommended.



*** Some number parts listed on the instruction sheet may not be in parts bag as they may already be assembled. Carefully check parts and packing materials prior to ordering replacements.

STEP 3

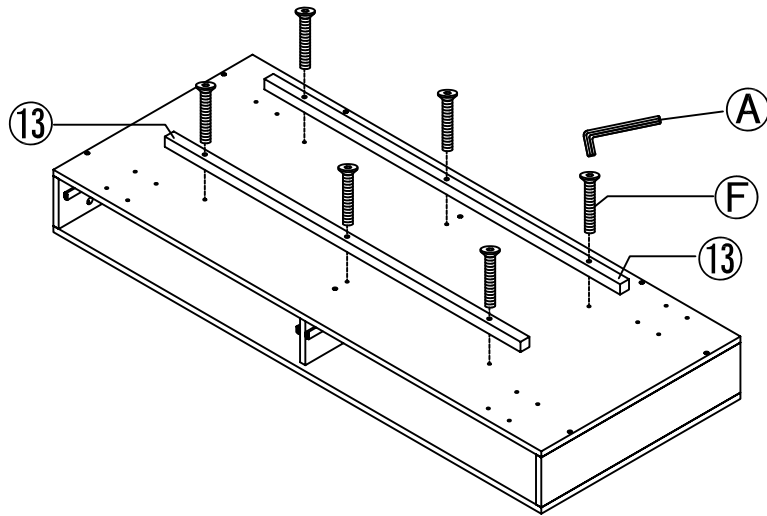

STEP 4

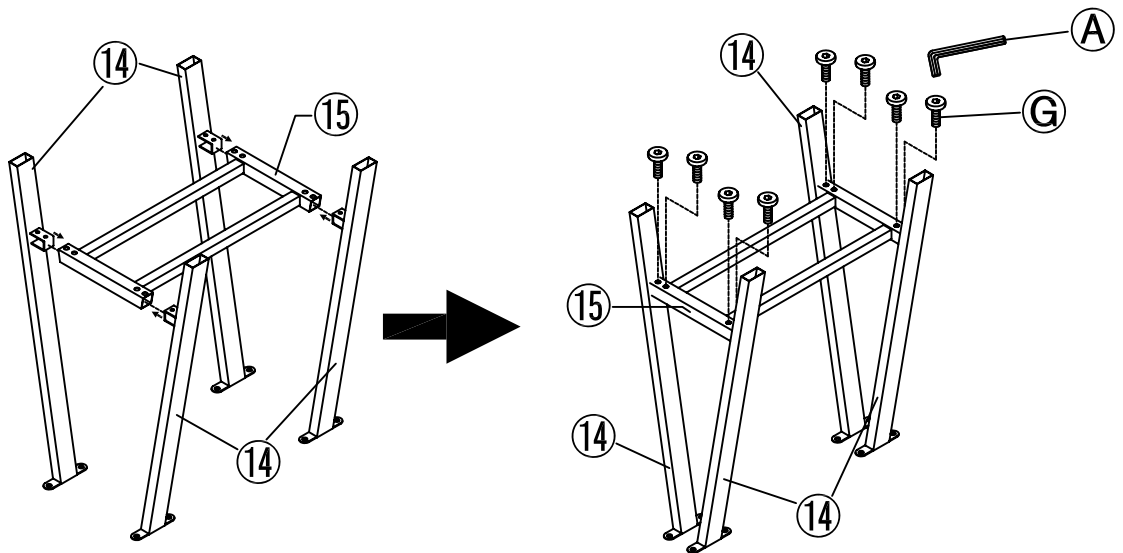

STEP 5

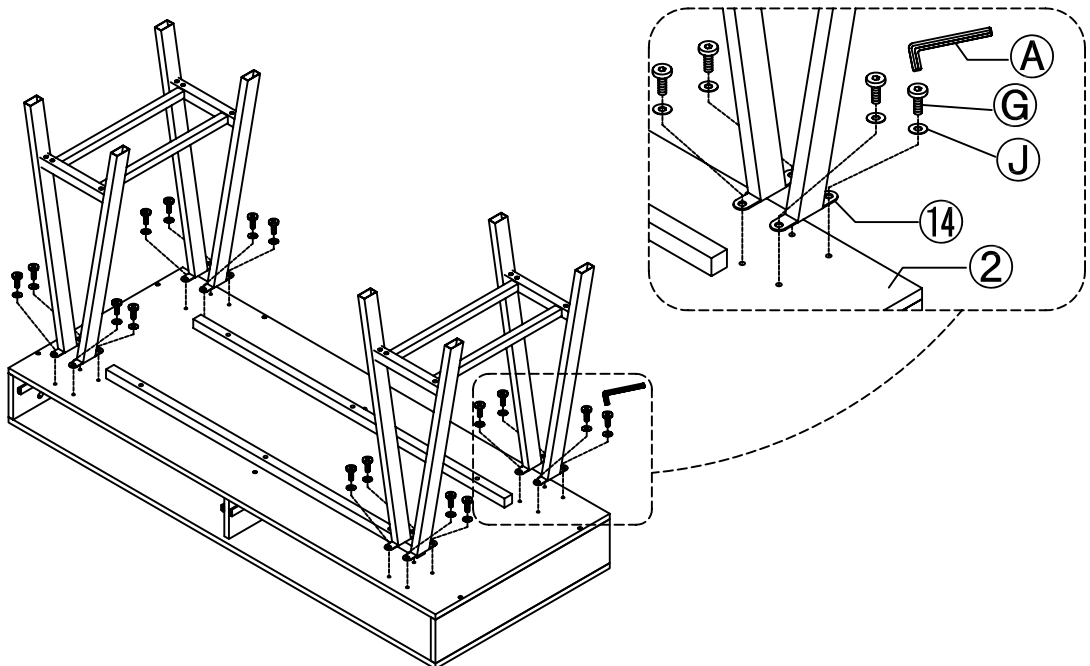

STEP 6

****Attention: Align the angularity of the plug (K) to the leg frame (14)!**

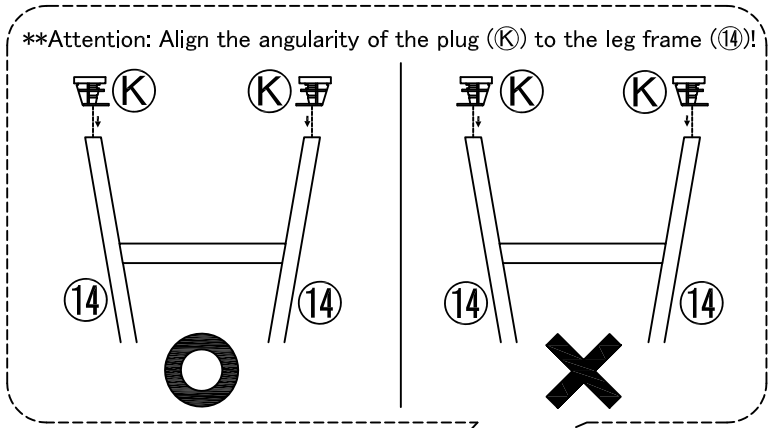
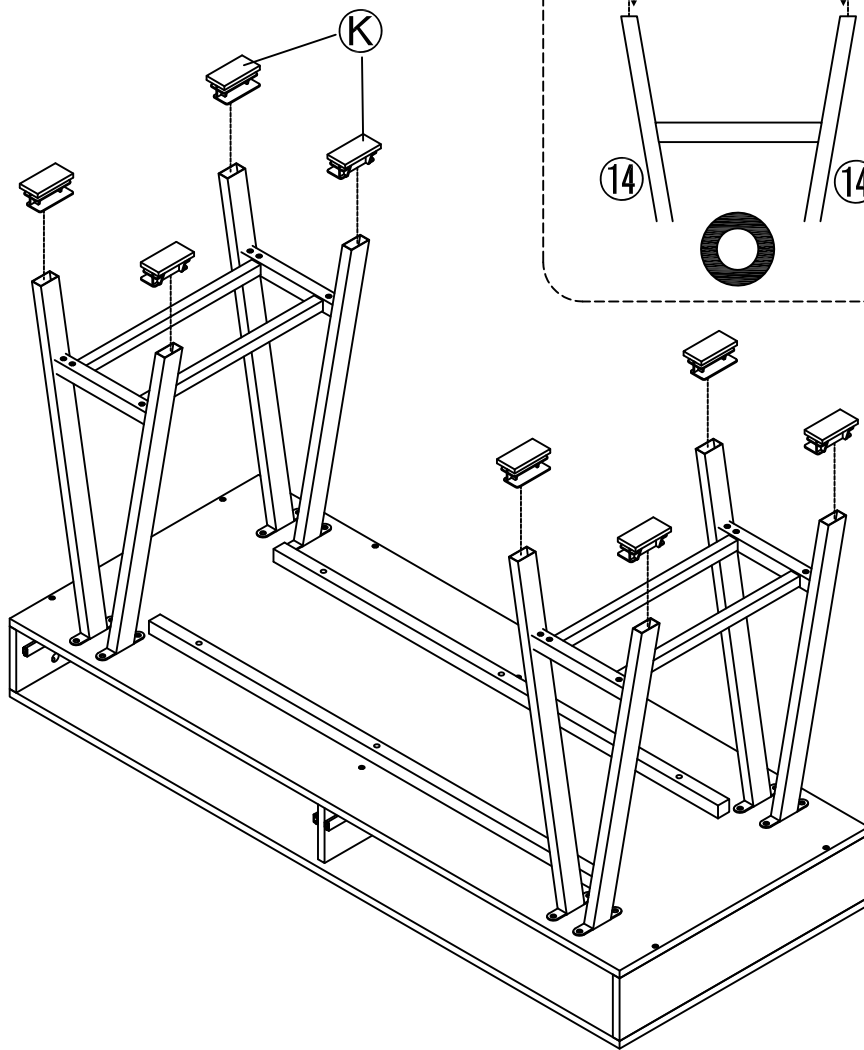

STEP 7

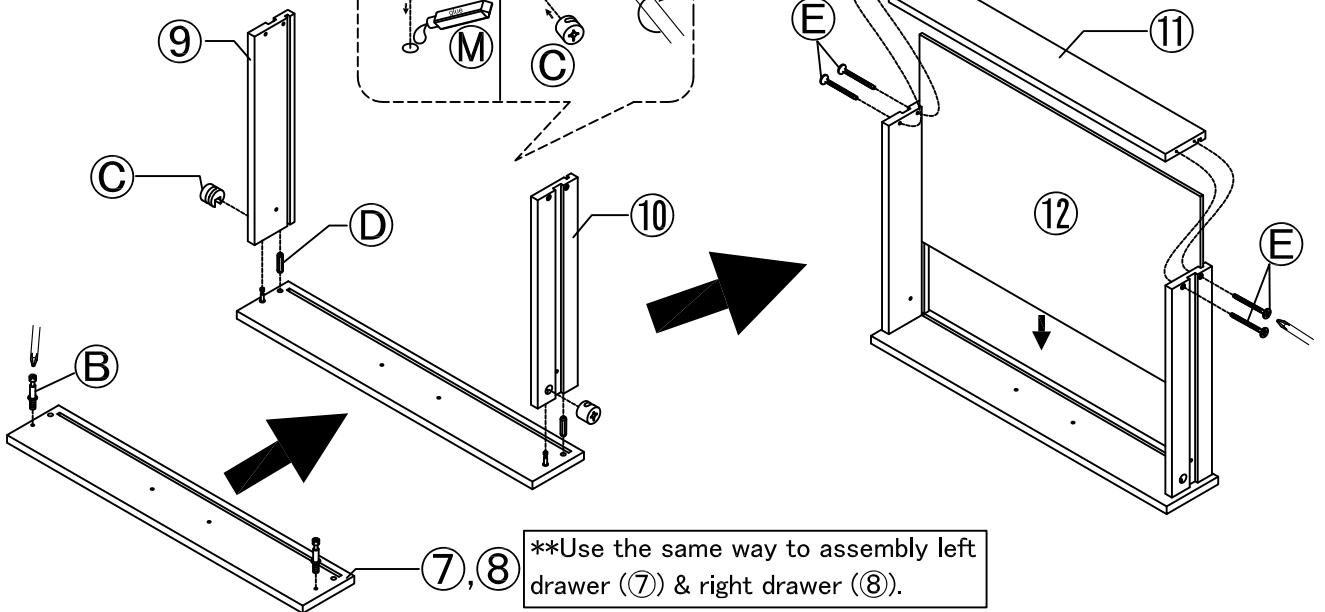
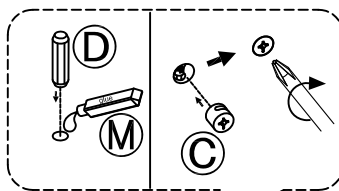

****Use the same way to assembly left drawer (7) & right drawer (8).**

STEP 8

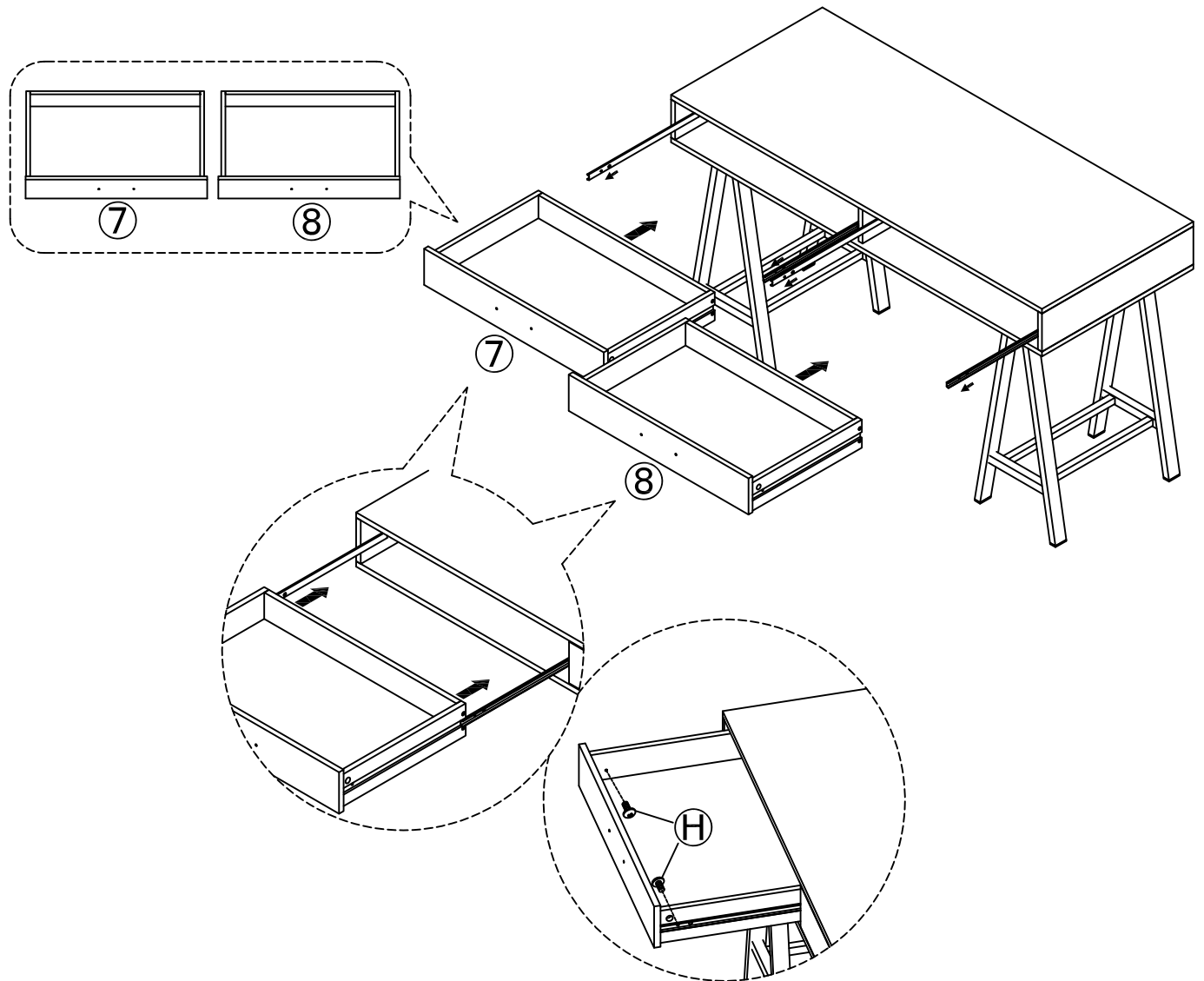

STEP 9

