

# Assembly Instruction

**CAUTION:** Read instruction carefully and turn electricity off at main circuit breaker panel before beginning installation.

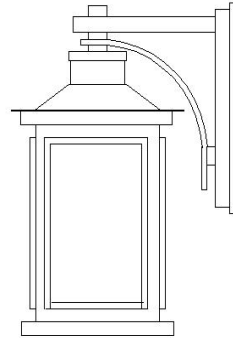

## Care and Cleaning











To clean the outside of the fixture, use a dry or slightly dampened clean cloth (use clean water, never a solvent) to wipe the surface of the fixture.

To clear the inside of the fixture, first disconnect power to the fixture by turning off the circuit breaker or by removing the fuse at the fuse box. Next, use a dry or slightly dampened clean cloth (use clean water, never a solvent) to wipe the interior surface of the fixture.

Do not use any cleaners with chemical, solvents or harsh abrasives. Use Only a dry soft cloth to dust or wipe carefully.

Estimated Assembly Time: 20 minutes

## Part List and Hardware List

PIECE	DESCRIPTION	PICTURE	QUANTITY	PIECE	DESCRIPTION	PICTURE	QUANTITY
A	mounting bracket		1X	F	wire connector		3X
B	machine screw		2X	G	mounting screw		2X
C	backplate		1X	H	ground screw		1X
D	washer		4X	J	Frame		1X
E	Cap Nut		2X	k	Studs		2X

# Installation

## Step 1

Loose the Screws(K) to remove the polyfoam from the Frame(J)

## Step 2

Install the mounting bracket(A) to the junction box with machine screw (B)

## Step 3 Wire connection

Make wire connections, with wire connectors(F), following the reference chart listed below.

Connect,Hot,Black or Red outlet Supply Wire to:	Connect,Neutral,White Outlet Supply Wire to:
Black	White
*Parallel Cord(round&smooth)	*Parallel Cord(square&ridged)
Clear,Brown,Gold or Black without Tracer(colored stripe)	Clear,Brwn,Gold or Black without Tracer(colored stripes)
Insulated Wire(not green)with copper metal conductor	Insulated Wire(not green)with Silver metal conductor

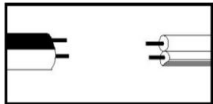

\*Note: When parallel wire(SPTI&SPTII)is used. The neutral wire is square shaped and ridged and the hot wire will be round in shape and smooth.(See illustration on left)



### Grounding Instructions:

a) For installation in the United States: Wrap ground wire from outlet box around green ground screw on mounting bracket, no less than 2" from wire end. Tighten ground screw. If fixture is supplied with a ground wire, connect to outlet ground wire with a wire connector.

b) For installation in Canada: If fixture is supplied with ground wire, wrap ground wire around green grounding screw on mounting bracket. Tighten ground screw.

## Step 4

Attach the backplate(C) to the junction box and fix it by turning the washer(D) and Cap Nut (E) clockwise

## Step 5

connect Frame(J) to the Top Hood(I)by using 2pcs Studs(K) and washer(D) .

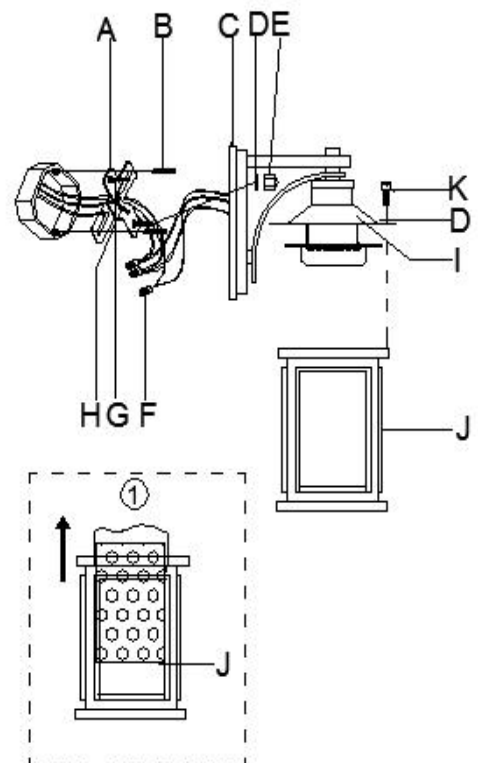

**There is 7 Watt LED On Lighting Fixture**

ENJOY YOUR LAMP