

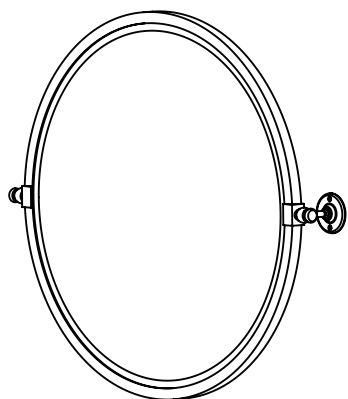



MOUNTING INSTRUCTIONS

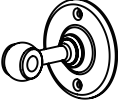
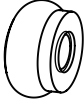

Contents:

				
Mirror X1	Bracket X2	Ball Finial X2	Screw X4	Anchor X4

Questions, problems, missing parts?

The hardware included with this item is meant for dry wall mounting only. If other wall types, please consult your local hardware store for assistance

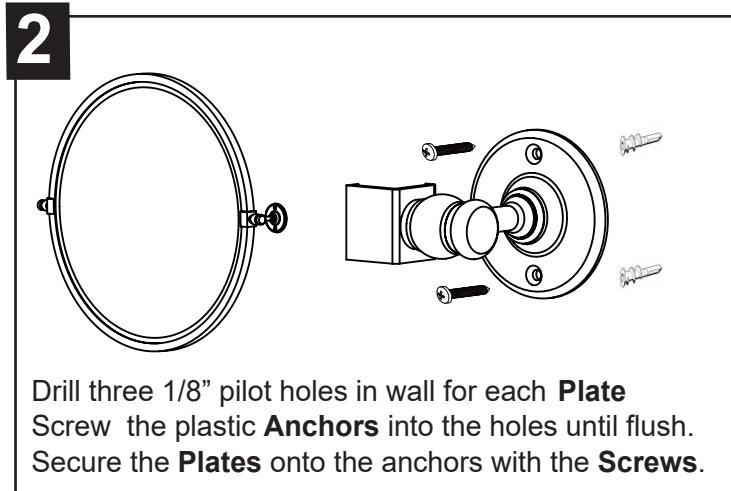
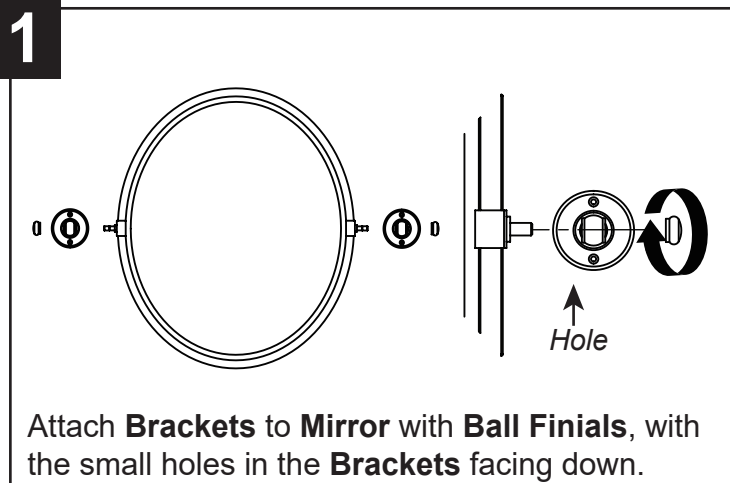

Cleaning

Avoid using commercial or abrasive cleaners. Using only a soft damp cloth will preserve the finish.