

## Parts and Damage Replacement Procedure

1. Please inspect your purchase immediately.
2. This procedure covers product purchased from an authorized and was received in its originally sealed carton.
3. If you find a part missing or damaged, you have a 30-day window in which to order a replacement part from the date on your purchase receipt.
4. You have 3 ways to do this. You will need a copy of your purchase receipt.
  - a. By Fax: Fax the parts order from below and along with your receipt to:
  - b. By Email: Email the order from and along with your receipt to:
  - c. By Mail: Fill out the parts order from below and along with a copy of your receipt send it to
5. Once this order is sent in, you will be notified if the part(s) you are requesting can or cannot be shipped

within 7-10 business days.

**A COPY OF YOUR PURCHASE RECEIPT OR INVOICE MUST BE ATTACHED TO THIS ORDER FORM.  
NO ORDERS WILL BE PROCESSED WITHOUT PROOF OF PURCHASE.**

NAME: \_\_\_\_\_

ADDRESS: \_\_\_\_\_ (No Post Office Boxes)

CITY: \_\_\_\_\_ STATE: \_\_\_\_\_ ZIP: \_\_\_\_\_

PHONE: \_\_\_\_\_ FAX: \_\_\_\_\_

EMAIL: \_\_\_\_\_

**REASON FOR REPLACEMENT/PLEASE CHECK APPROPRIATE BOX.**

- ( ) Damaged /scratched, cracked, broken, crushed, etc.
- ( ) Mechanical malfunction/ drawer glides, swivel mechanisms, lid stays, etc.
- ( ) Missing pieces
- ( ) Unfinished surface
- ( ) Wrong color
- ( ) Other



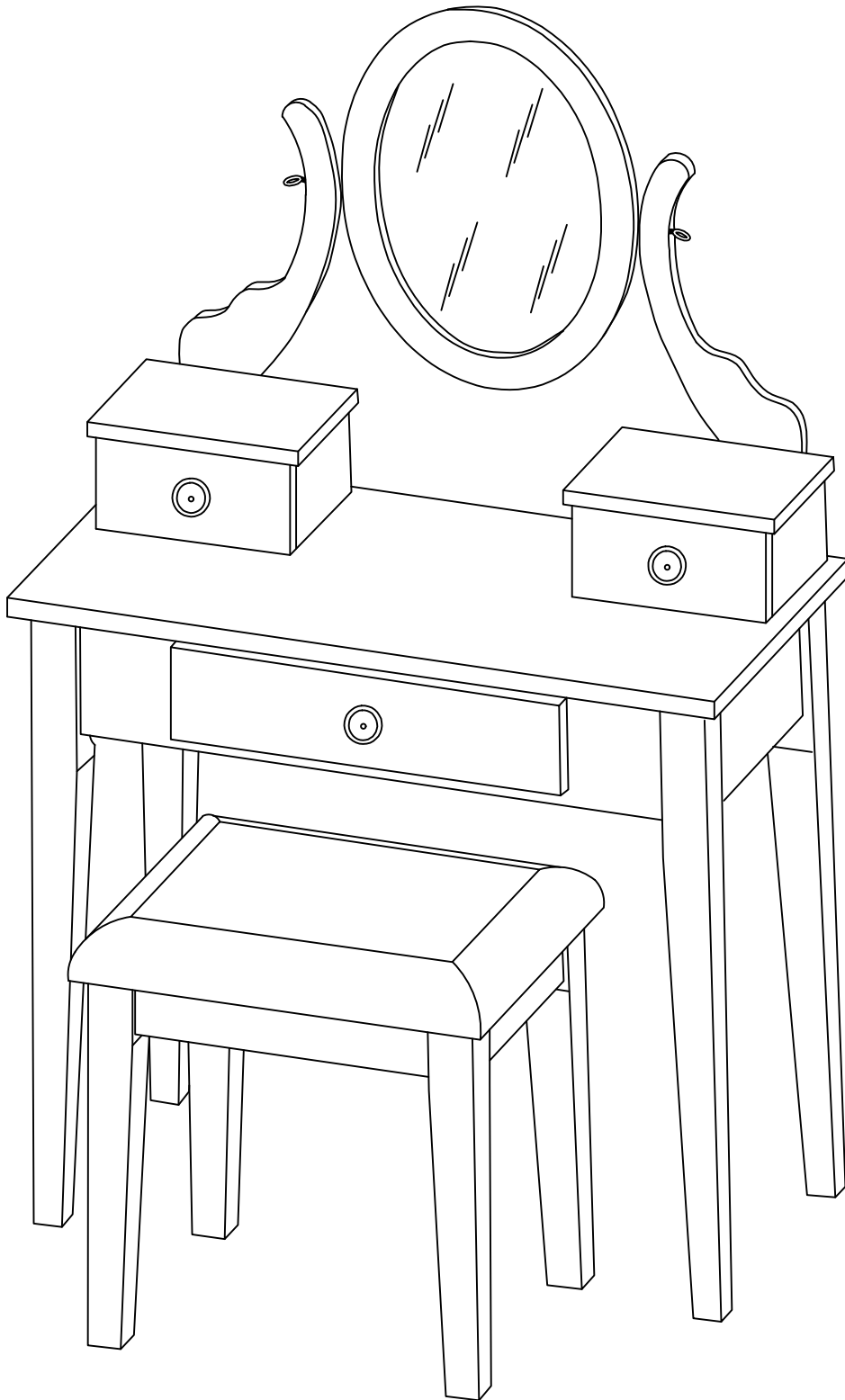

IF MORE THAN ONE MODEL NUMBER IS LISTED ABOVE, PLEASE SPECIFY THE EXACT MODEL NUMBER OF YOUR ITEM IN THE SPACE PROVIDED BELOW.

Model Number	Part Letter Code	Quantity

# ASSEMBLY INSTRUCTIONS

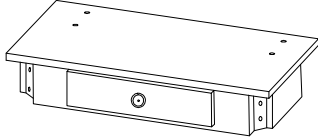
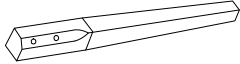
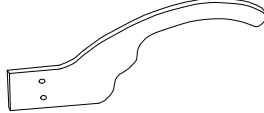
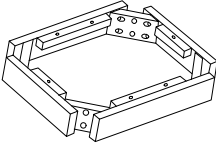
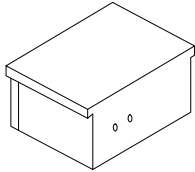

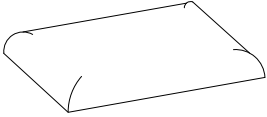
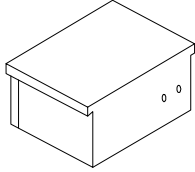
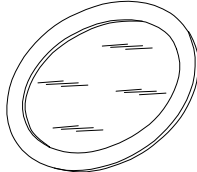
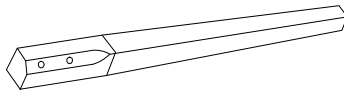
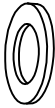
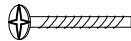
# ASSEMBLY INSTRUCTIONS

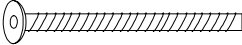
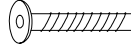
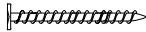
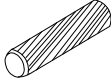
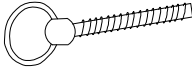
<b>Parts List</b>		
<p>Ax1</p> 	<p>Dx4</p> 	<p>Gx1</p> 
<p>Bx1</p> 	<p>Ex1</p> 	<p>Hx1</p> 
<p>Bx2</p> 	<p>Fx1</p> 	<p>Ix1</p> 
<p>Cx1</p> 		
<b>Hardware List</b>		
<p>Jx16</p> 	<p>Mx4</p> 	<p>Px1</p> 
<p>Kx16</p> 	<p>Nx4</p> 	<p>Qx6</p> 
<p>Lx2</p> 	<p>Ox2</p> 	
<b>2 / 4</b>		

# ASSEMBLY INSTRUCTIONS

STEP 1

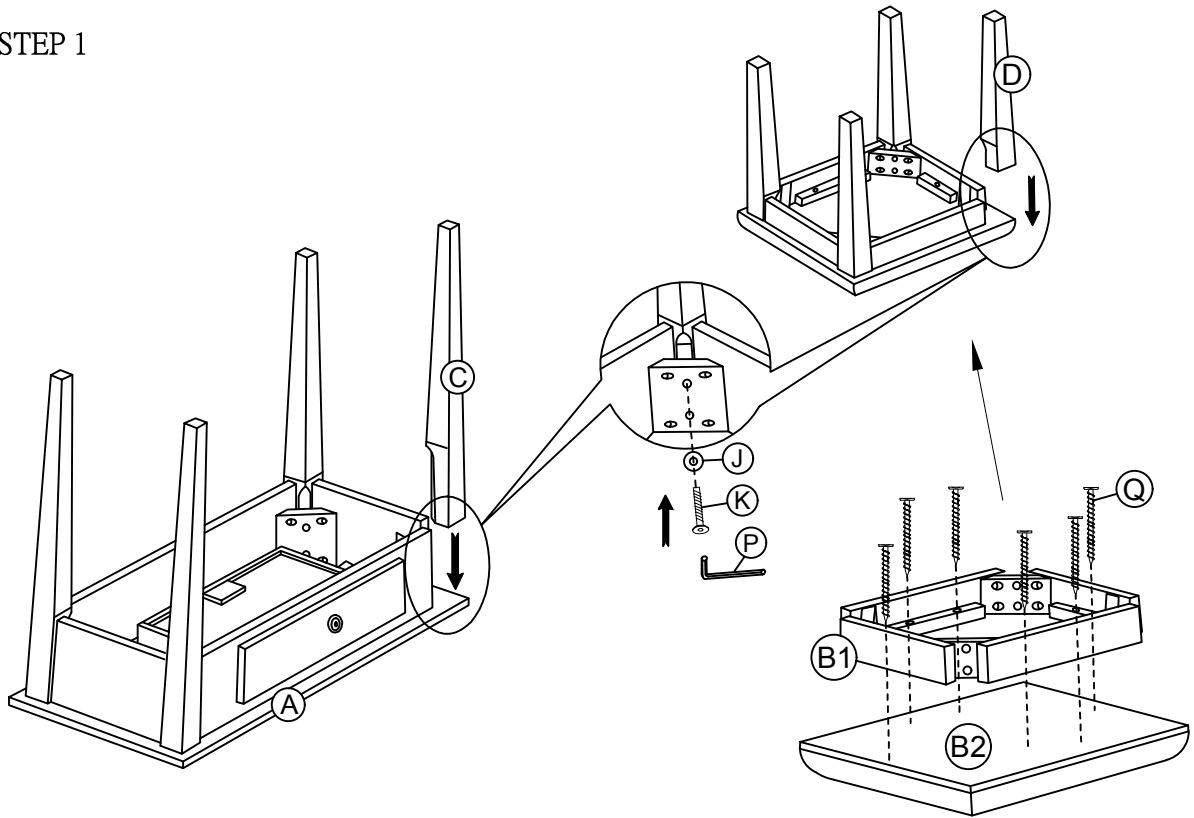

STEP 2

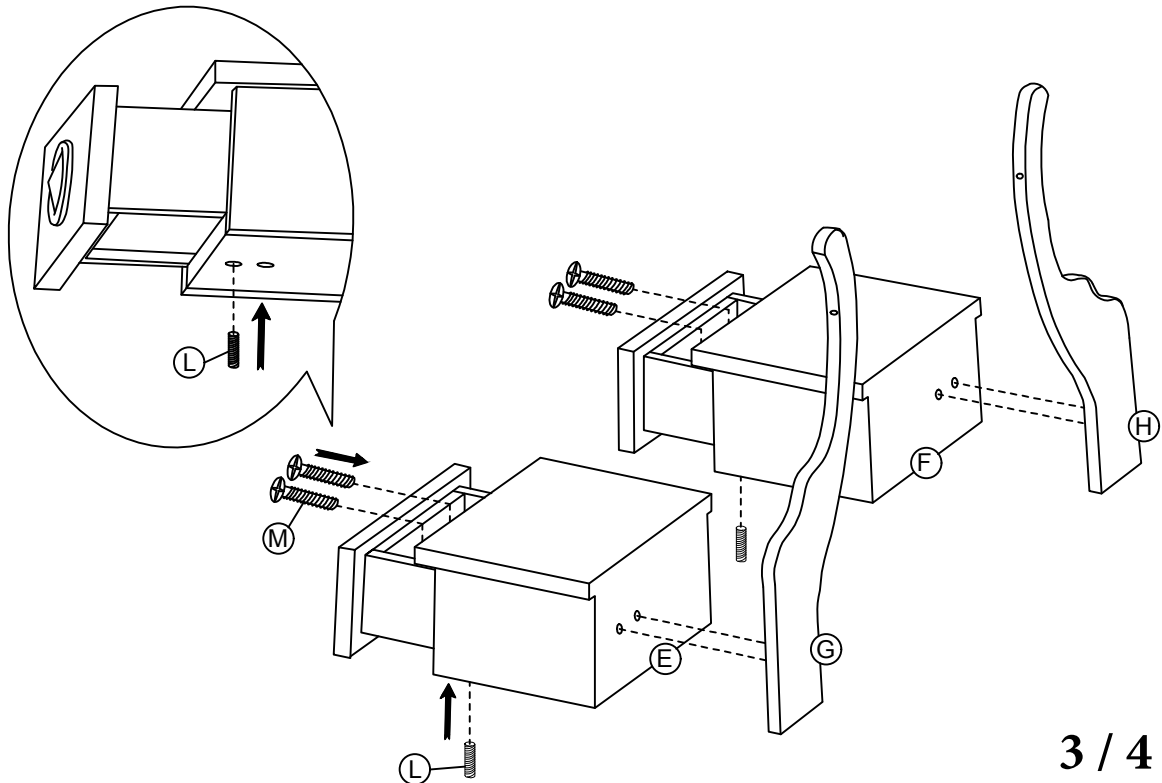

# ASSEMBLY INSTRUCTIONS

STEP 3

