







Product Assembly Instructions I

Swivel Barstool

Helpers needed to assemble: 2

Estimate time frame to assemble: 20 minutes

- Step 1:** Aligen the frame(2) onto the bottom of seat (1).
- Step 2:** Put the bolts(A) through holes of frame and swivel.
- Step 3:** Put the washer (C) and nut (B) on the bottom of bolt as picture

#	Picture	Description	Quantity
1		Seat	1
2		Frame	1
A		Bolts(M6x25)	4
B		Nut	4
C		Washer	4
D		Allen Key	1

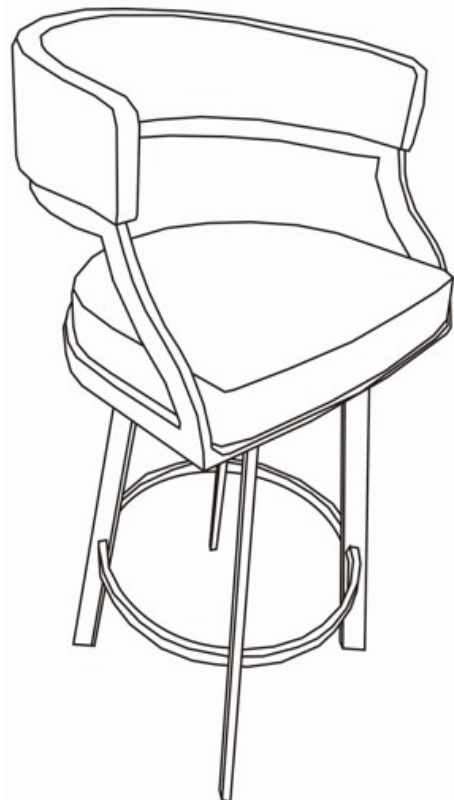
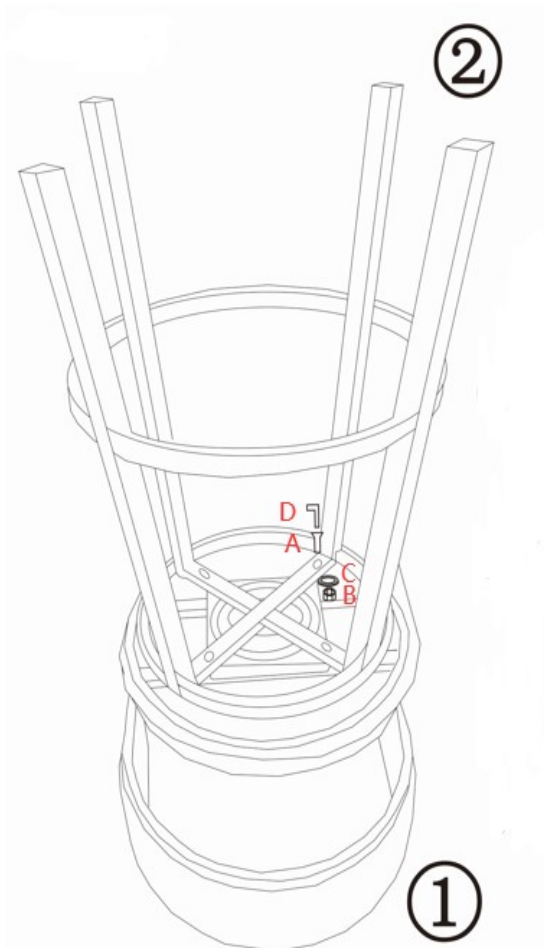

- Step 4:** Hold the nut not moving, and use allen key (D) to afix the bolt into nut until tighten.
- Step 5:** Test the barstool is firmly on the ground and the seat does not wiggle.
- Step 6:** Sit and enjoy your new barstool.

* Keep the Allen Key and Tighten all screws each 3 months for safety concern!