

# Bookshelf

## Instruction Manual

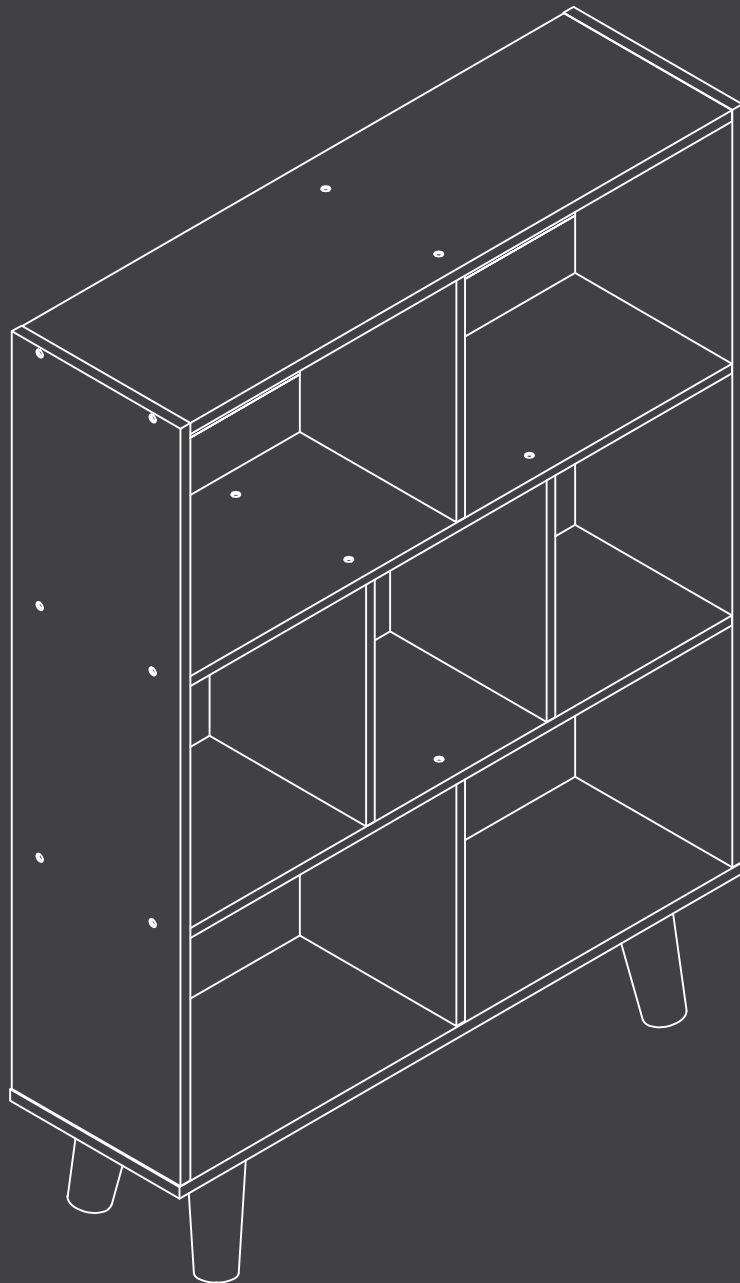

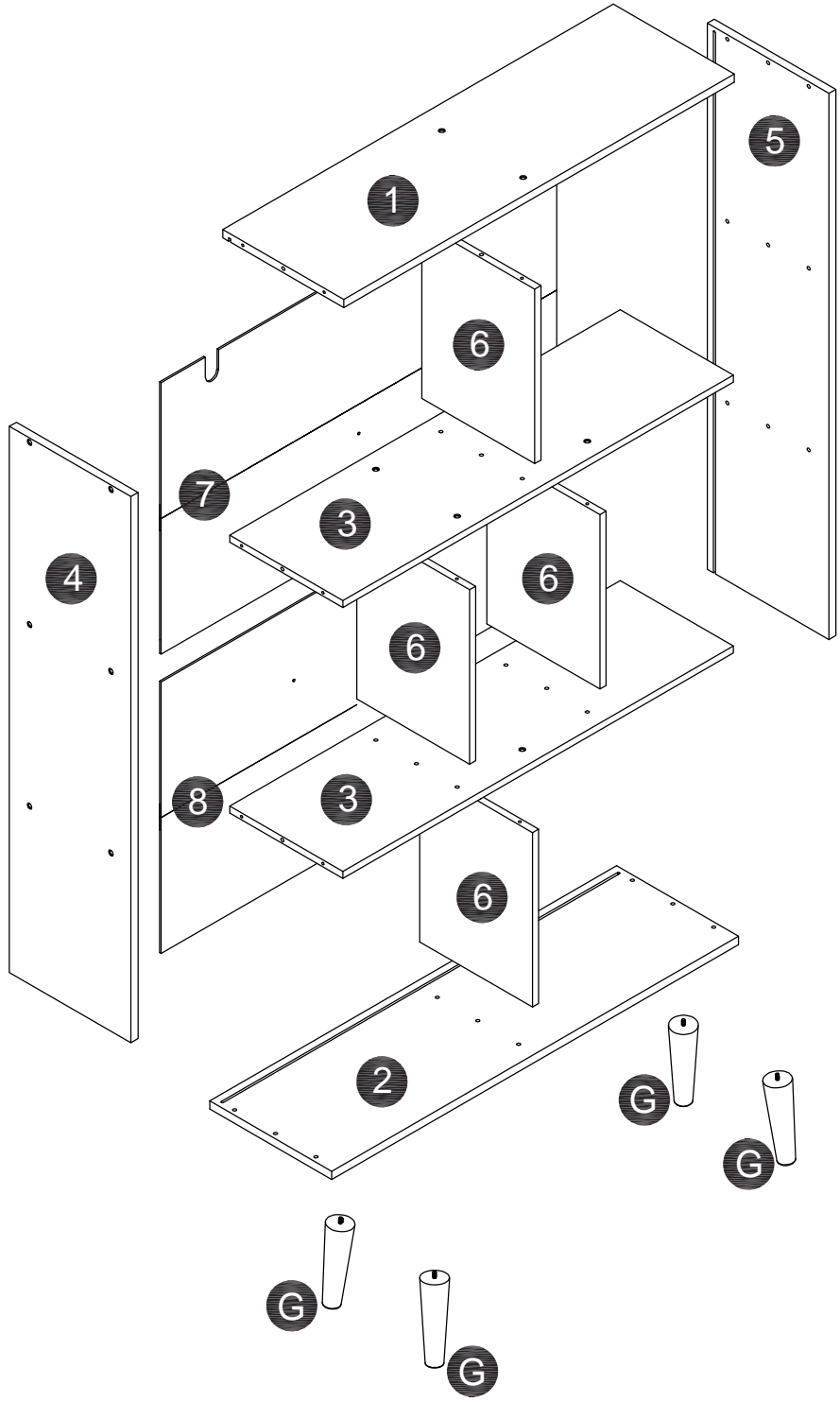

# 1 Component List

---

1 X1

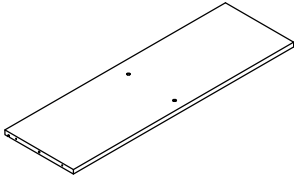

2 X1

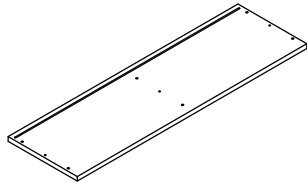

3 X2

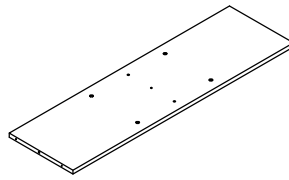

4 X1

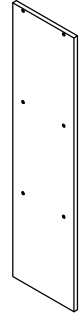

5 X1

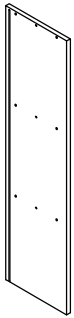

6 X4

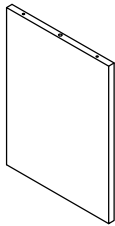

7 X1

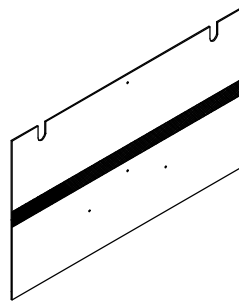

8 X1

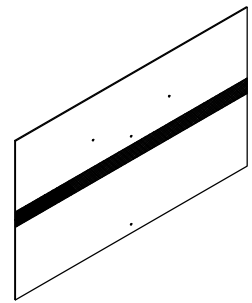

## 2 Supplied Parts and Hardware

**A** X32+2

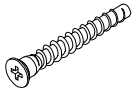

Ø9.5\*Ø6.2\*40mm

**B** X16+1

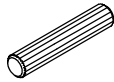

Ø6x30mm

**C** X4



Solid Wood Foot Connector

**D** X28+2



Ø3.5x15mm

**E** X1

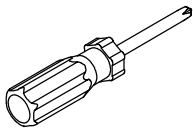

**F** X2SETS

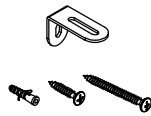

**G** X4



**H** X20

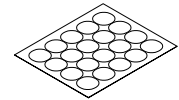

**I** X12



Ø3.5x12mm

**J** X12

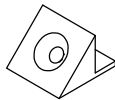

Please have the following auxiliary tools ready:  
Bitte halten Sie folgende Hilfswerkzeuge bereit:  
Veuillez préparer les outils auxiliaires suivants :  
Si prega di avere pronti i seguenti strumenti ausiliari:  
Por favor, tenga listas las siguientes herramientas auxiliares:

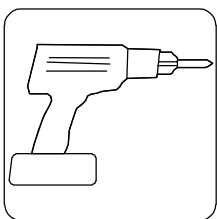

Electric Drill

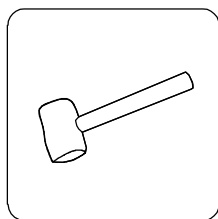

Hammer

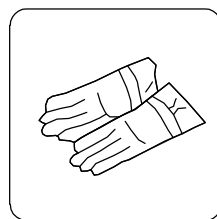

Gloves

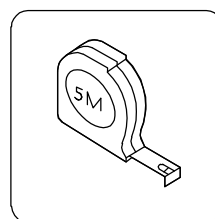

Tape Measure 5M

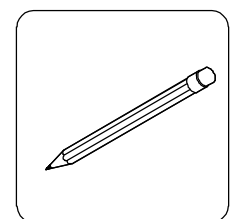

Pencil

**NOTE:** This product requires at least two people for installation.

# Step 1

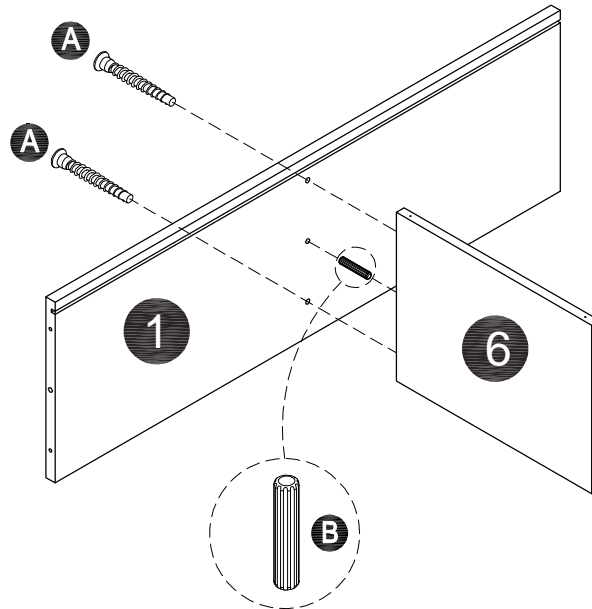
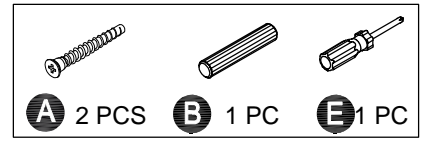

# Step 2

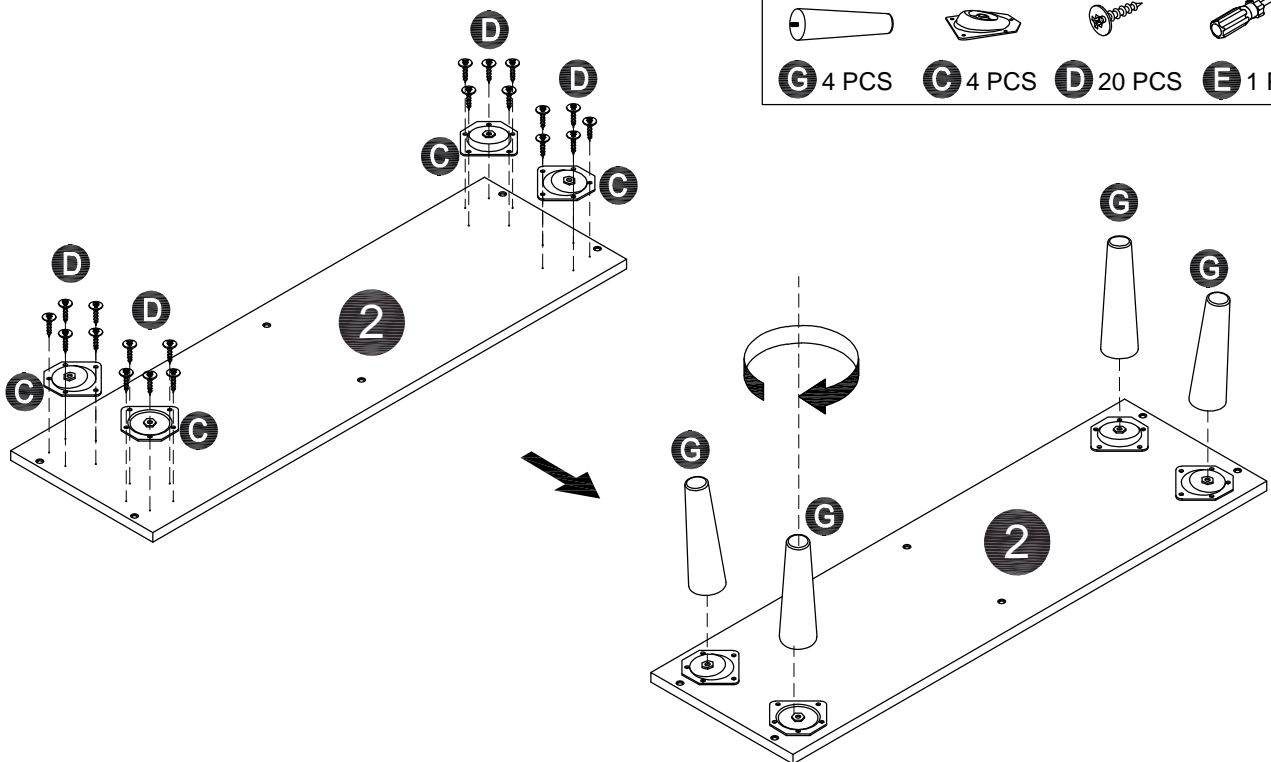

# Step 3

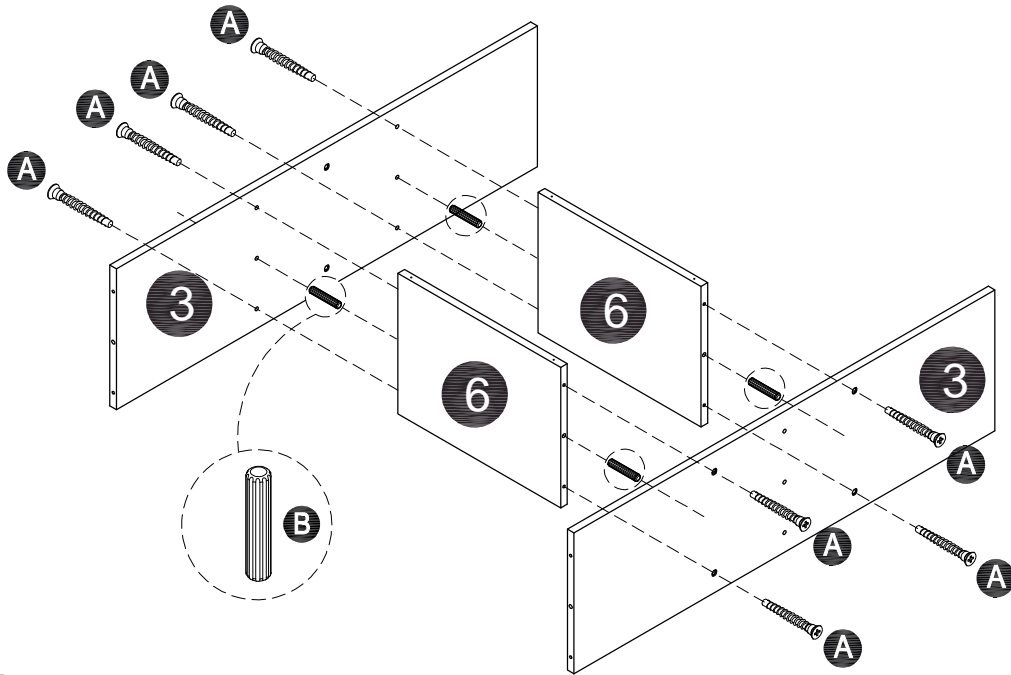
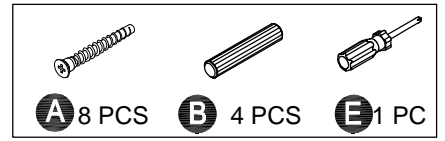

# Step 4

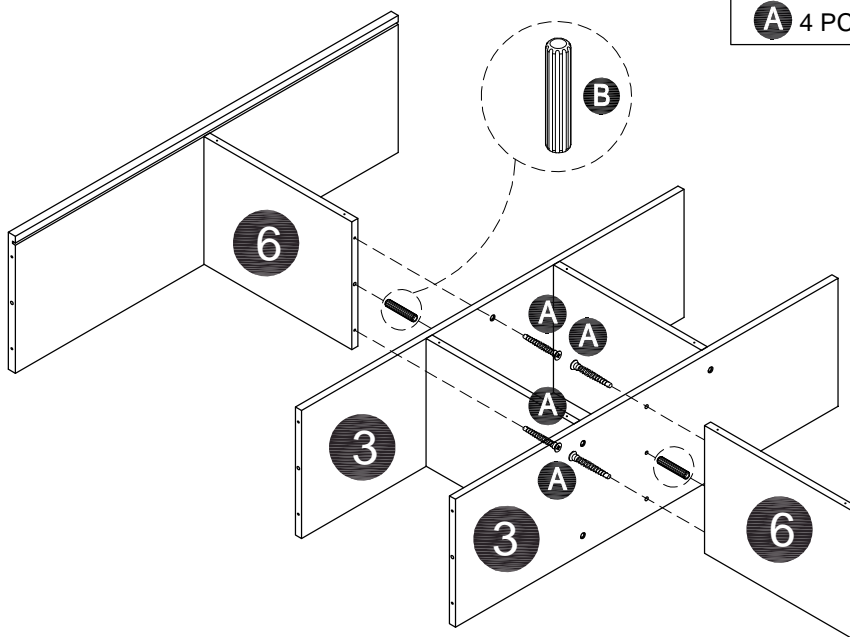
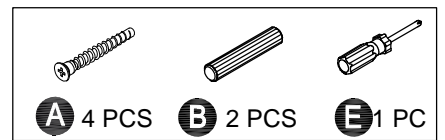

# Step 5

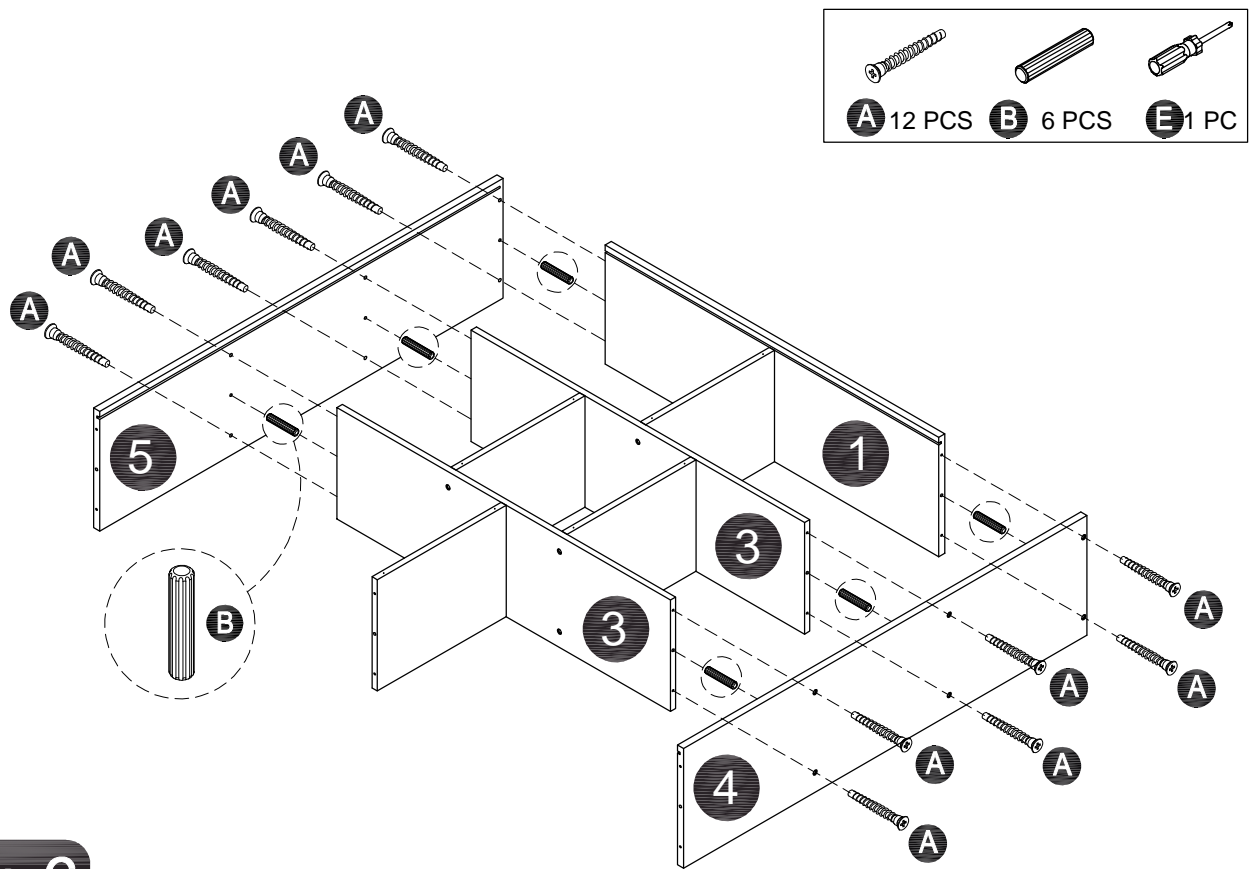

# Step 6

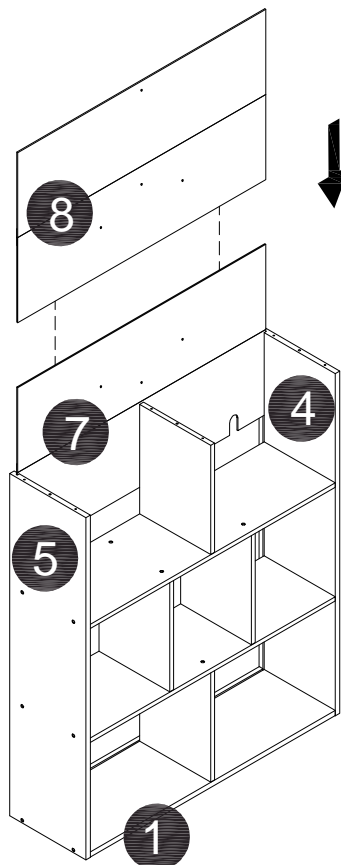

# Step 7

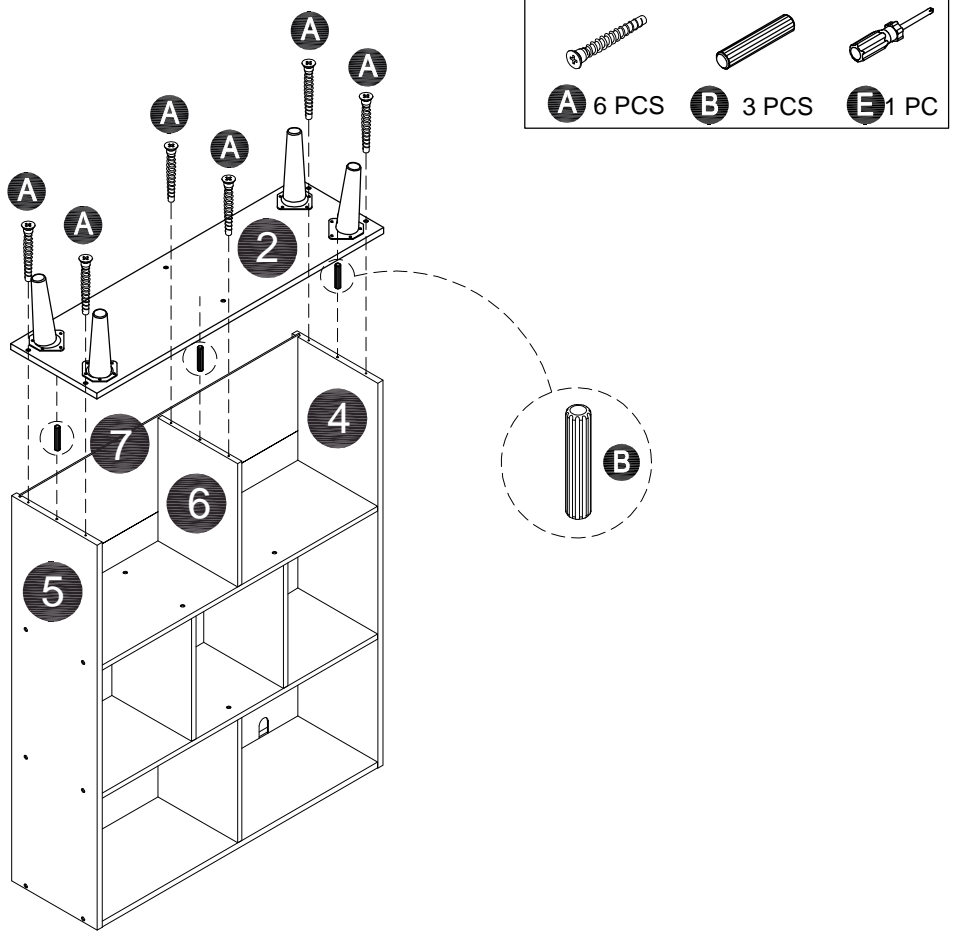

# Step 8

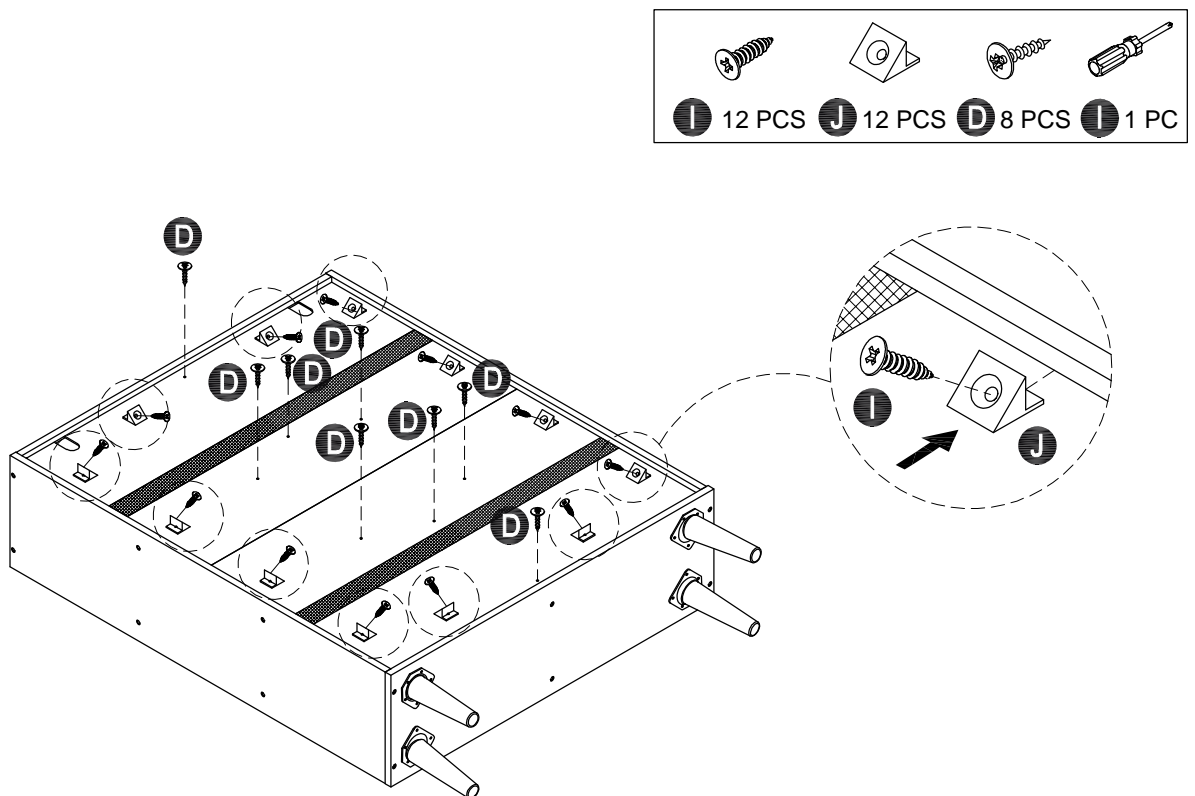

# Step 9

## Install the anti-tip kit

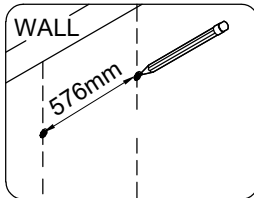

1. Make mark on the wall

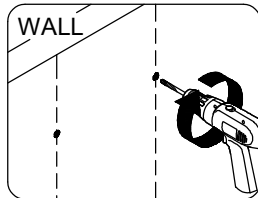

2. Drill two 6 holes on the wall

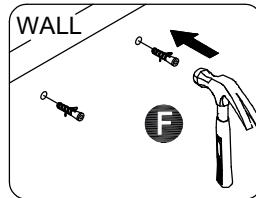

3. Put two anchors in the holes

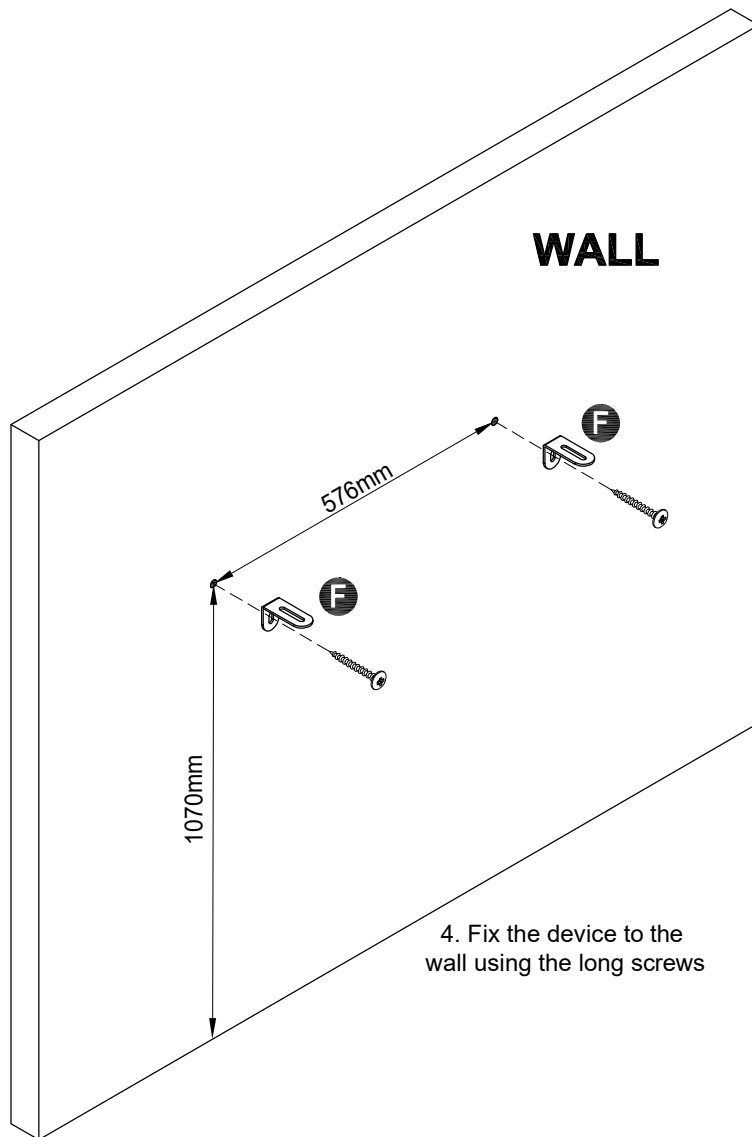

4. Fix the device to the wall using the long screws

# Step10

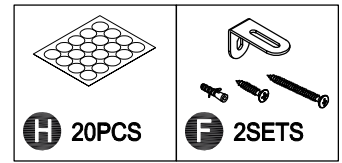

NOTE:  
Move the cabinet into position **F**, Pencil, electric drill,  
and hammer not included.

