

MASSAGE RECLINER

ASSEMBLY INSTRUCTIONS

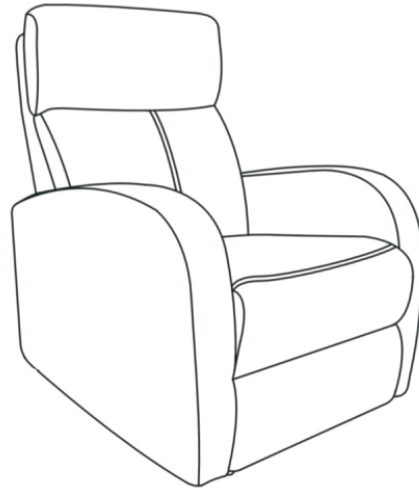

THANK YOU FOR PURCHASING RECLINER SOFA

PART LIST

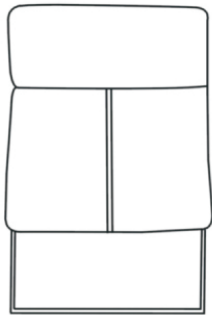

①

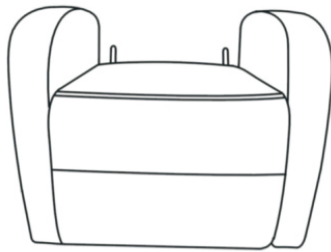

②

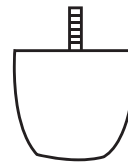

③



④

WARNING

- This sofa is designed for one person weighing up to 275lbs(125kgs).
- Avoid exposing furniture directly to sunlight or heating and air conditioning outlets. Do not place your upholstery furniture too close to windows, radiators, or vents,, and be sure to use window treatments to block the sun's rays.
- Do not use rough cleaning tool or corrosive detergent to clean the sofa.
- Some of the parts are heavy and/or has shape edge ,please install it carefully to avoid hurt you and people around you.

- If any parts are missing, broken, damaged or worn, stop using the sofa until repairs are made and factory replacement parts are installed.

STEP:

MATCH BOTH SIDE HOOK-LOOP BRACKET AND PUSH DOWN BACKREST TO ASSEMBLY

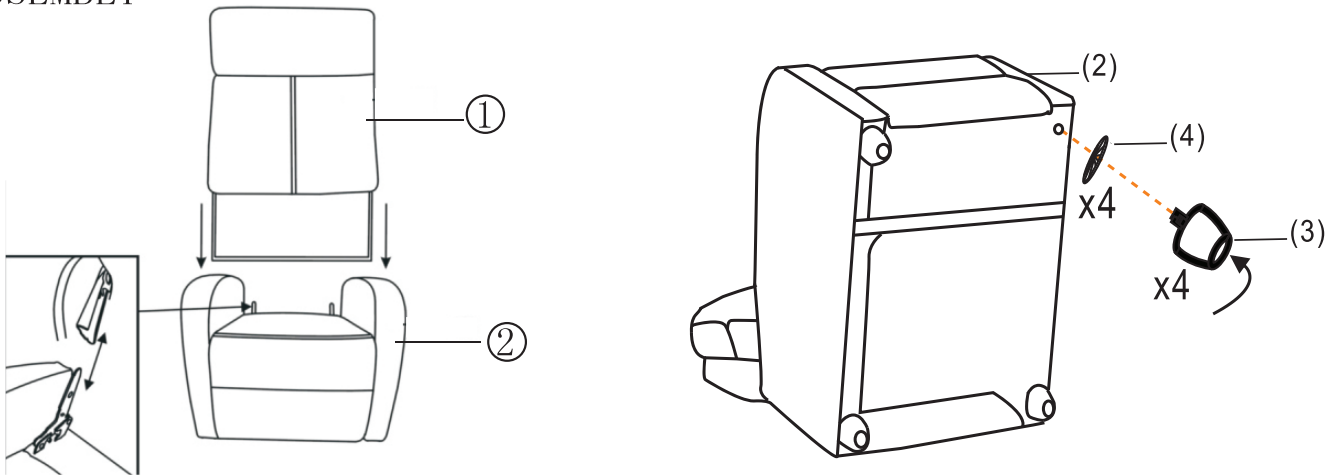

STEP: ASSEMBLE FOUR PLASTIC LEGS

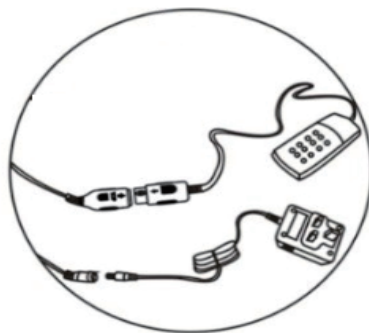

STEP:

IF YOU WANT TO REMOVE THE BACKREST FROM THE BASE YOU HAVE TO PUSH THE BACK BY THE BODY WEIGHT

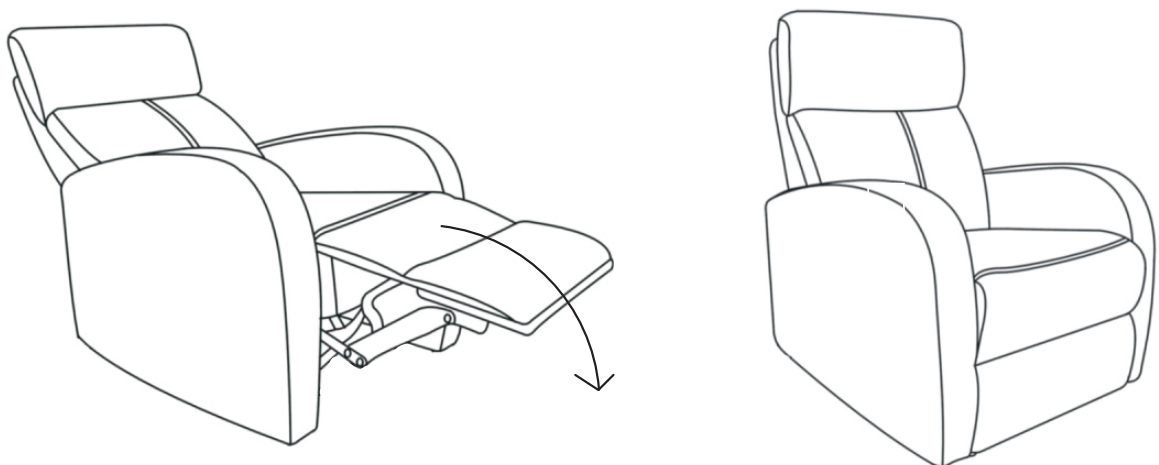

STEP:

CLOSE THE FOOTREST WITH LEGS THEN YOU CAN STAND UP.

MASSAGE CHAIR

READ ALL INSTRUCTIONS
BEFORE USING THE ITEM



PRODUCT FEATURE

- 2 Vibration Motors
- 8 Massaging modes
- Adjustable intensity
- One massage zones
- The default timing is 15-30 min

HOW TO USE

- 1、 Turn the unit ON by pressing the POWER button once, The LED will illuminate when power is on.
- 2、 Turn on the massage in each zone by pressing the Massage zone. LEDs will illuminate when each zone is activated. To turn off a zone, press the button again.

- 3、 To choose a desired massage mode, press the MODE button. To change modes, press MODE button until LED for desired mode illuminates
- 4、 To change the massage intensity press the INTENSITY button. The LED for HIGH or LOW intensities will illuminate when chosen.
NOTE: Discontinue use immediately if you feel any discomfort or pain.
- 5、 NOTE: for your benefit, the massage chair is equipped with an auto shut-off feature that will turn the chair unit off after 30 minutes of continuous use.
- 6、 DO NOT use for more than 30 minutes of continuous use.

IMPORTANT SAFETY INSTRUCTIONS

When using an electrical appliance, basic precautions should always be followed, including the following:

- 1、 This product is for use on a 12V circuit Make sure that the product is connected to an outlet having the same configuration as the plug.
- 2、 Always unplug the massager from the power source after use, and before cleaning.
- 3、 Do not reach for massager if it has fallen into water. Unplug immediately.
- 4、 An appliance should never be left unattended when plugged in. Unplug from outlet when not in use, before putting on or taking off parts or attachments.
- 5、 Do not use outdoors.
- 6、 Do not carry this appliance by supplied cord as a handle.
- 7、 Keep the cord away from heated surfaces.
- 8、 Close supervision is necessary when this appliance is used by on or near children, invalids or disabled persons.
- 9、 This unit is not a toy. Children should not use it or play with it.
- 10、 Do not operate where aerosol (spray) products are being used or where oxygen is being administered.
- 11、 Do not use near eyes or other highly sensitive areas.
- 12、 To disconnect, push "POWER" key to "OFF" place, make sure all

functions stopped, then remove plug from outlet.

- 13、 Keep cord away from heated surfaces.
- 14、 Use this appliance only for its intended use as described in this manual. Do not use attachments not provided with the unit.

HEALTH CAUTION

- If you have any concerns regarding your health, consult your doctor before using this product.
- Individuals with pacemakers should not use this product.
- If you experience pain in a muscle or joint for a prolonged period of time. Discontinue use and consult your doctor. Persistent pain could be a symptom of a more serious condition.

MAINTENANCE INSTRUCTIONS

TO STORE:

Place unit in its box or safe, dry, cool place. Avoid contact with sharp edges or pointed objects which might cut or puncture the fabric. Do not wrap power cord around the unit. Do not hang the unit by power cord.

TO CLEAN:

- Insure the unit is unplugged from the power source, and allow to cool before cleaning.
- Do not place in any liquid to clean. Clean fabric cover by wiping with a damp sponge, using a mild detergent or suds. Pat dry with clean, dry cloth.
- Do not use abrasive cleaners, brushes, gasoline, kerosene, glass /furniture polish, paint thinner or water hotter than 120*to clean the unit.
- To clean the unit, make sure the massager is unplugged. Allow the unit to cool and the wipe down with a damp clean cloth. Do not use any strong chemical cleaners.

.....END.....