

ASSEMBLY INSTRUCTIONS

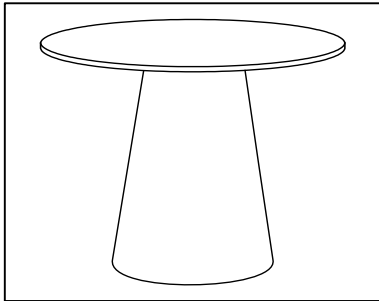

**+Do Not Use
Power Tools**



**+ Suggested
Adults**



NOTE:

1. Read instructions cover to cover.
2. Save all packaging until assembly is completed.

1. IMPORTANT SAFETY INFORMATION
Do not assemble the product if any of the following parts arrived damaged
Part # 1 - Top
Part # 2 - Base

2. IMPORTANT ASSEMBLY INFORMATION
Assembly step : use bolt A to connect Part 1 to Part 2 .

***Warning :** Do not over tighten screws, or it could damage the Table Top.

+Parts Included

① Top
(1 Pc)



② Base
(1 Pc)

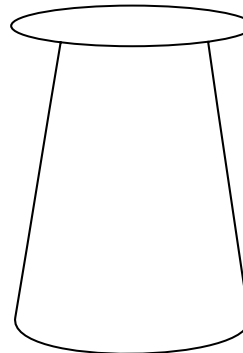

+ Hardware Included

A. Allen bolt 6 (Pcs)



B . Allen KEY (1Pc)

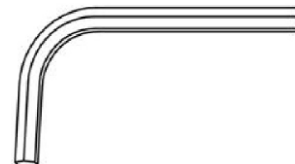

ASSEMBLY INSTRUCTIONS

1

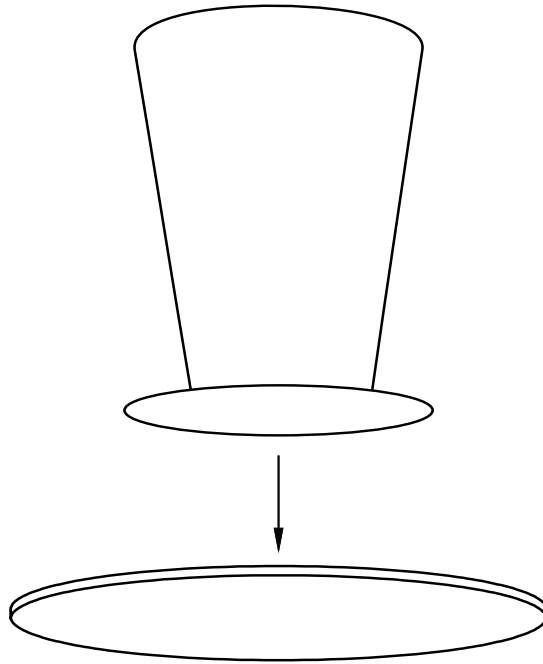

2

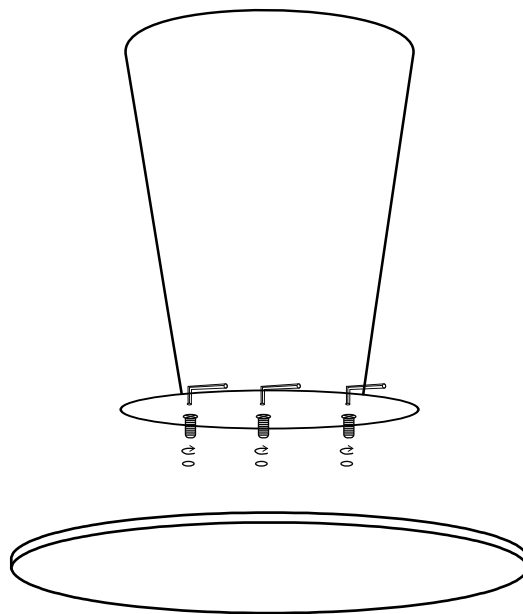

Note: Do not over tighten screws