

ASSEMBLY INSTRUCTIONS

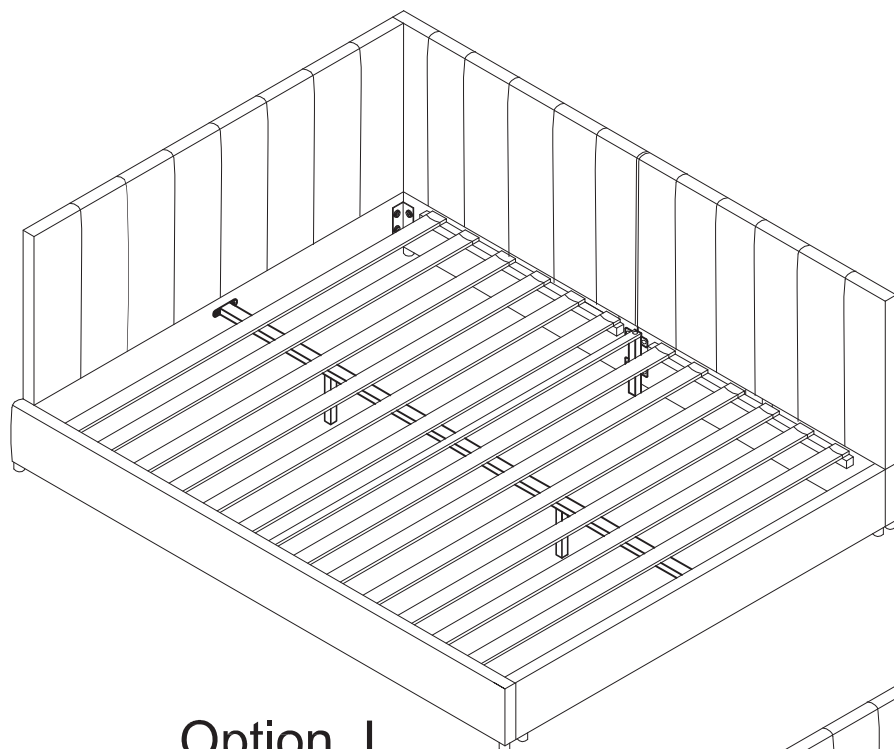

Option L

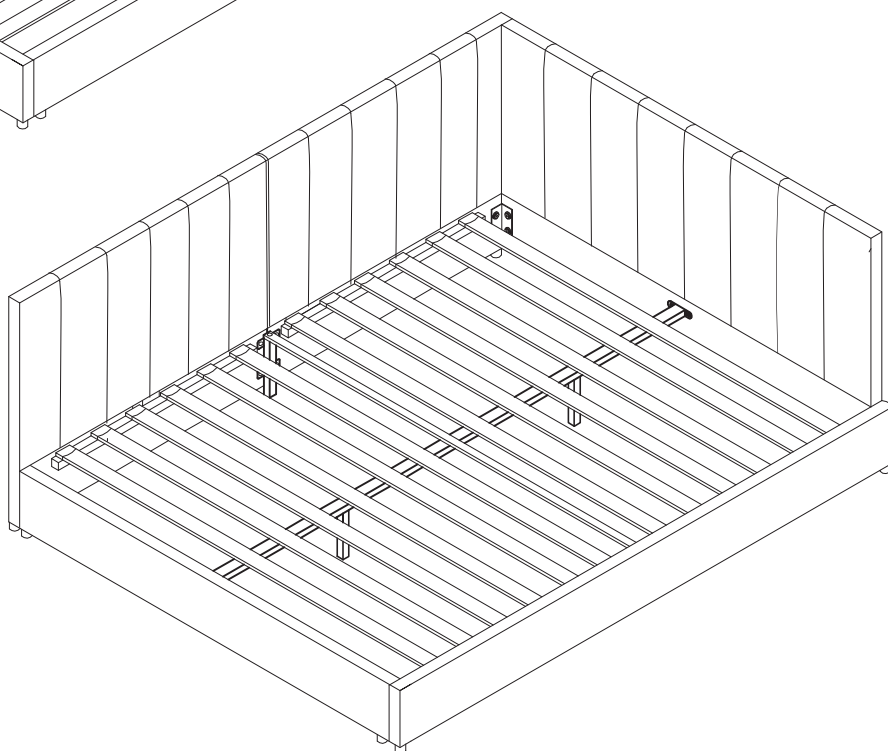







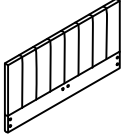
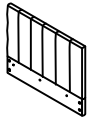
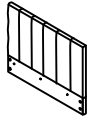

Option R

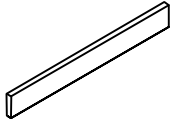
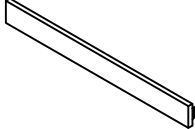
Set up the bed according to the needs of the room to choose the direction. Option L & Option R



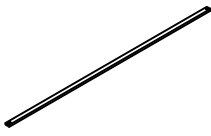
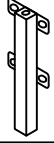



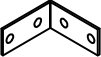

Install all screws according to the instructions, and then tighten them completely.

PACKING DETAILS:TOTAL 2 BOXES

BOX- 1/2	
PART	
	① Headboard 1PC
	③ Side rail -1 1PC
	④ Side rail -2 1PC

BOX-2/2	
PART	
	② Footboard 1PC
	⑤ Side rail- 3 1PC
	⑥ SR Support Rail 2PCS
	⑦ Center support rail 1PC
	⑧ Support Leg 2PCS
	⑨ Center cross bar 1PC
	⑩ Side Rail Feet 1PC
	⑪ Leg 8PCS
	⑫ Slat 12PCS
	⑬ Single Sided Plastic cap 24PCS

PACKING DETAILS:TOTAL 2 BOXES

BOX-2/2	
PART	
	⑭ 4PCS
	⑮ 1PC
	⑯ 2PCS
	A m8*30mm 37PCS
	B m6*50mm 10PCS
	C m6 4PCS
	D m6*19mm 14PCS
	E m8 37PCS
	F m8*19mm 37PCS
	G m8 1PC

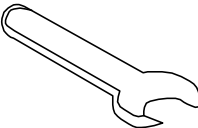
	H m6 1PC
	I m6 1PC

STEP 1

Side Rail -1&-2

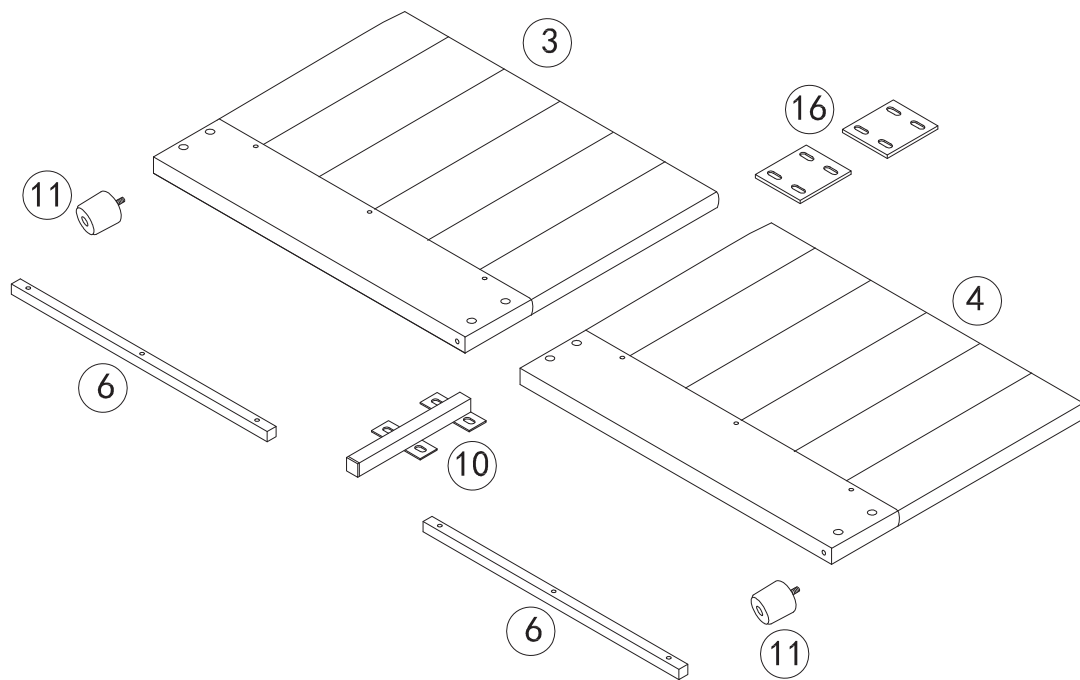



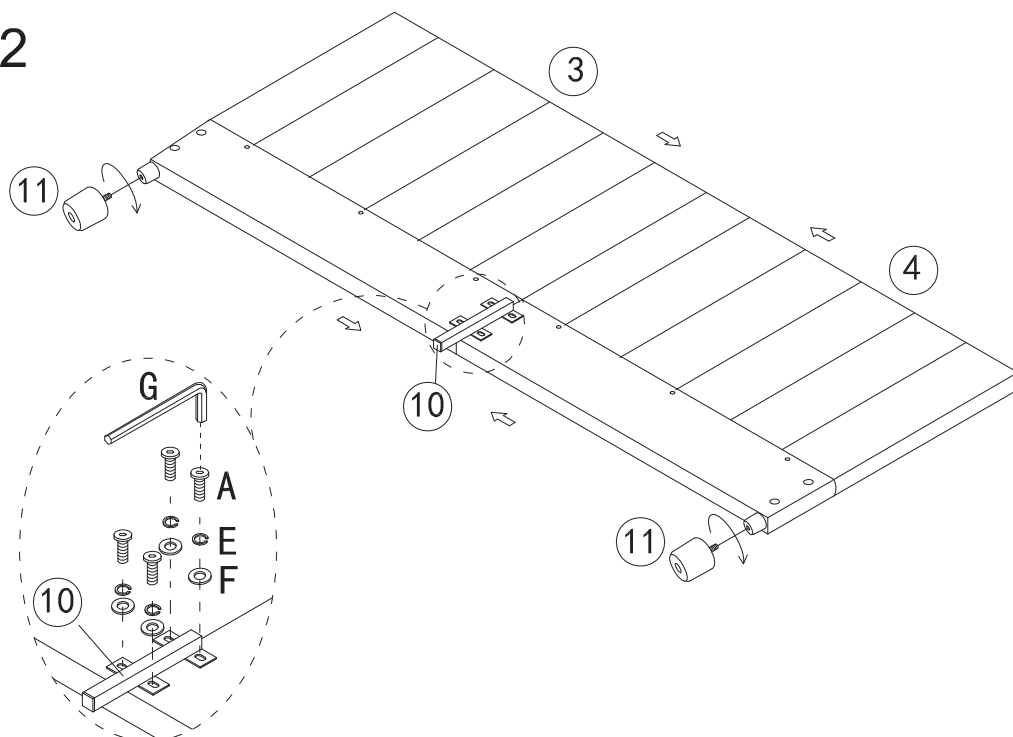

STEP 2

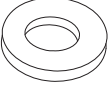
Side Rail -1&-2





m8*19mm

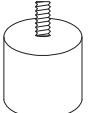

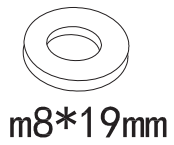
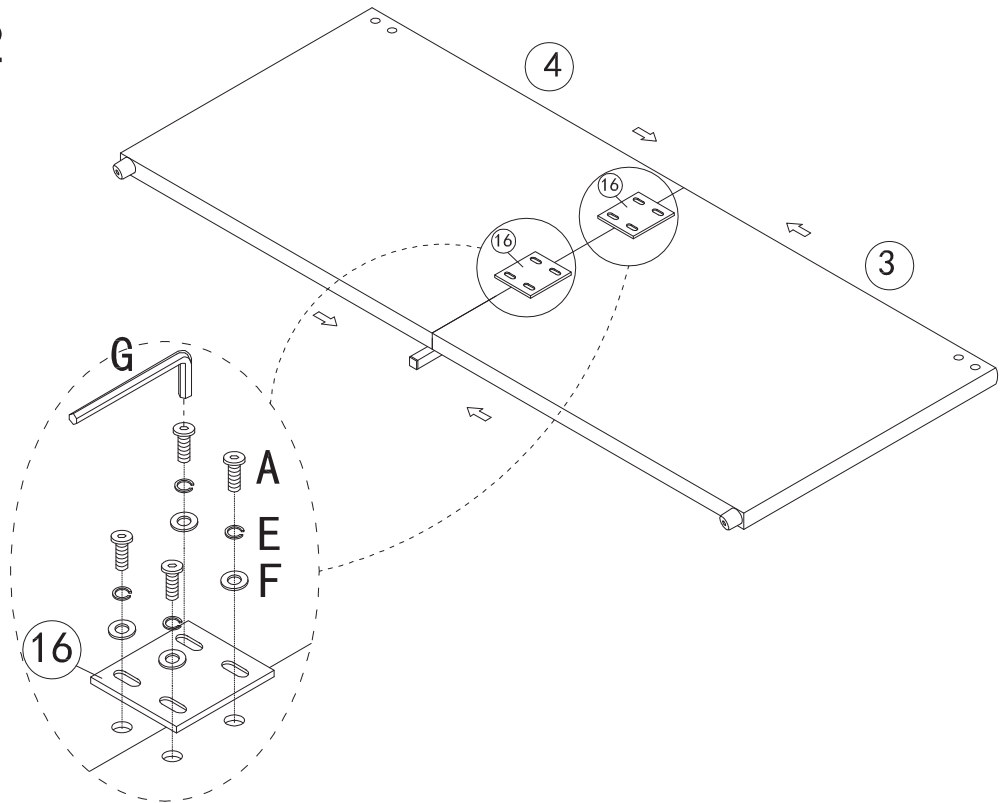

	A x4PCS
	F x4PCS
	E x4PCS
	G x1PC

 11 x2PCS

STEP 3

Side Rail -1&-2



	A x8PCS
	F x8PCS
	E x8PCS
	G x1PC

STEP 4

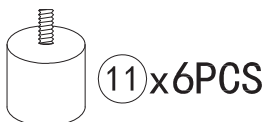
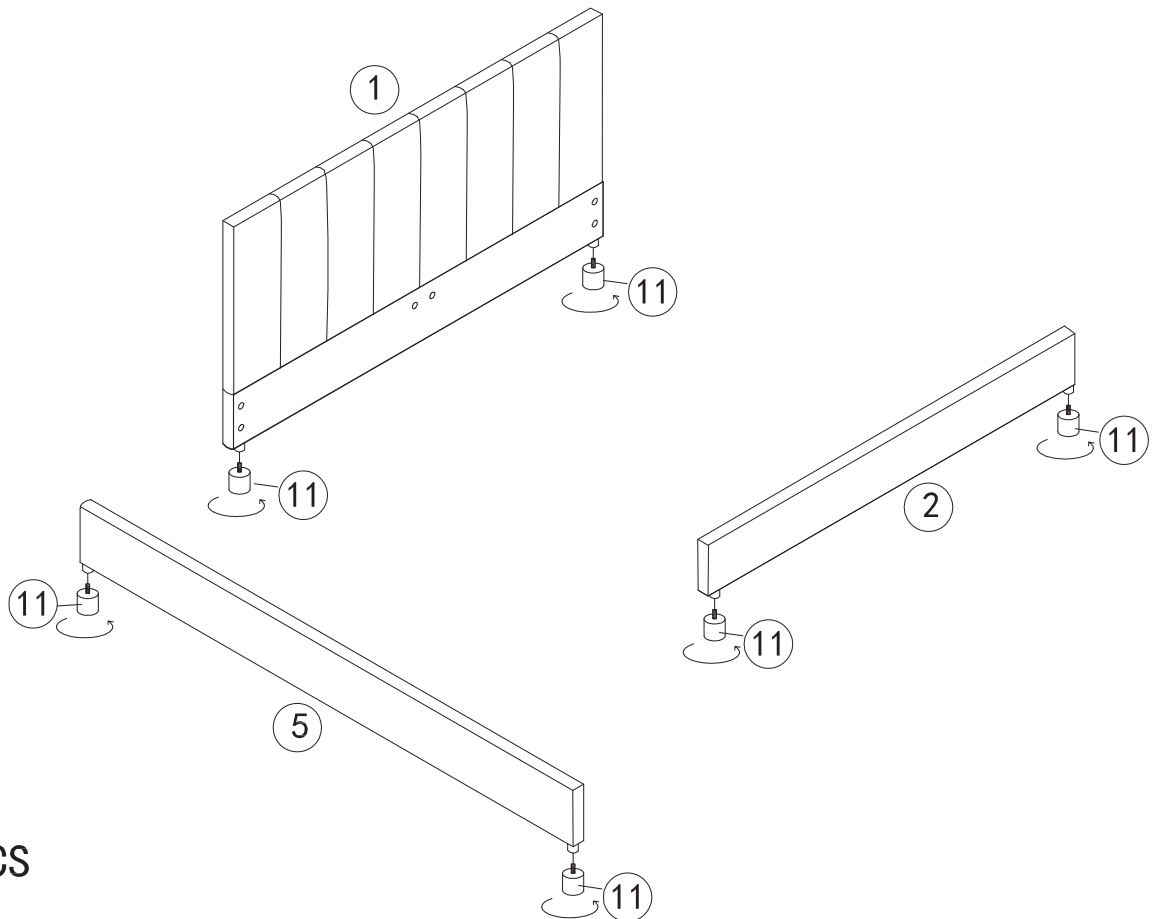

STEP 5



Install all screws according to the instructions, and then tighten them completely.

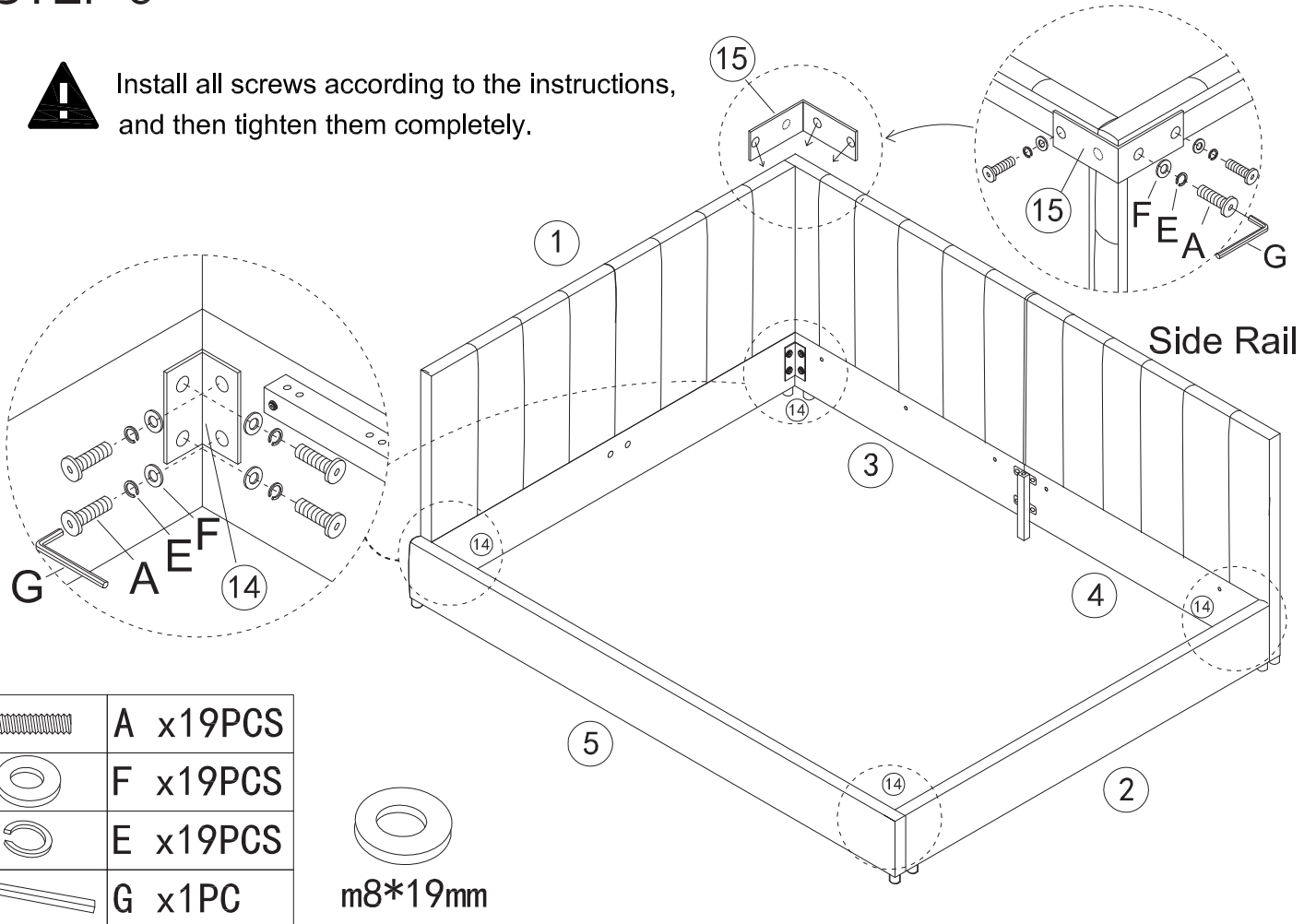

	A x19PCS
	F x19PCS
	E x19PCS
	G x1PC

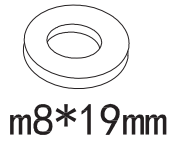



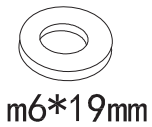
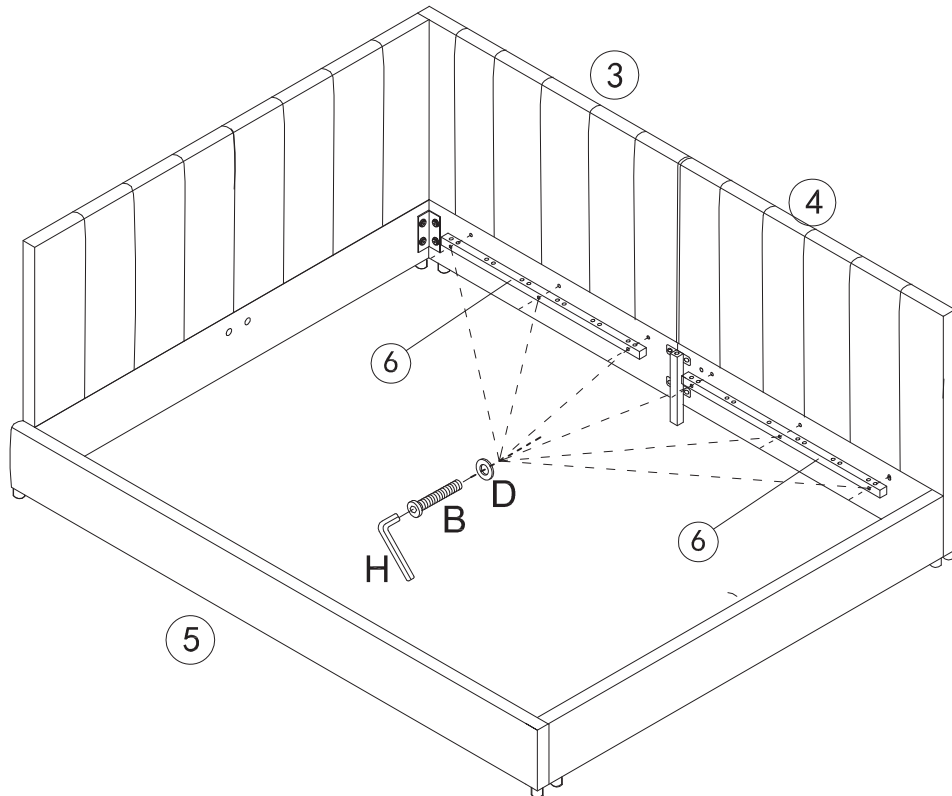



STEP 6

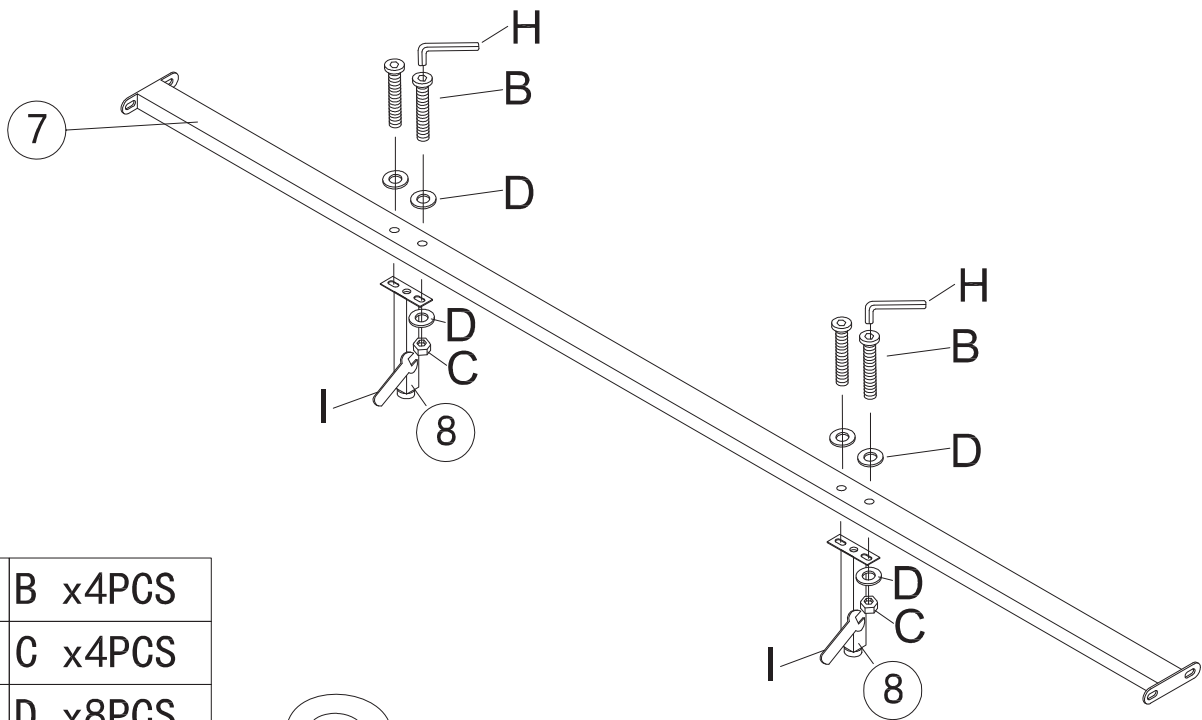

	B x 6PCS
	D x 6PCS
	H x 1PC

STEP 7





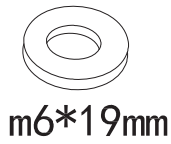

	B x4PCS
	C x4PCS
	D x8PCS
	H x1PC
	I x1PC

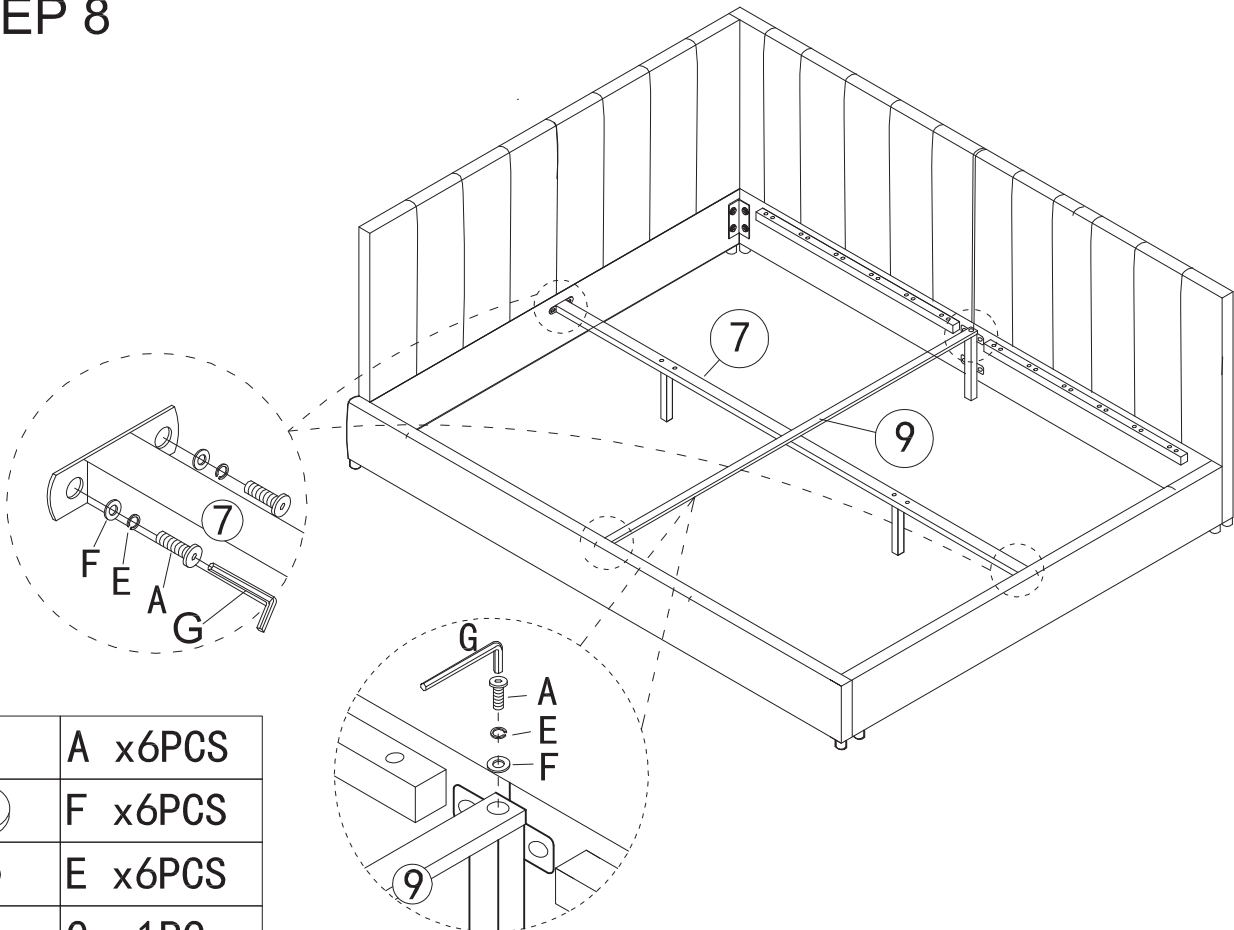



STEP 8

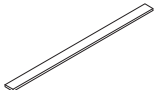

	A x6PCS
	F x6PCS
	E x6PCS
	G x1PC

STEP 9

<p>⑫ Slat</p>  <p>12PCS</p>	<p>⑬ Single Sided Plastic cap</p>  <p>24PCS</p>
--	--

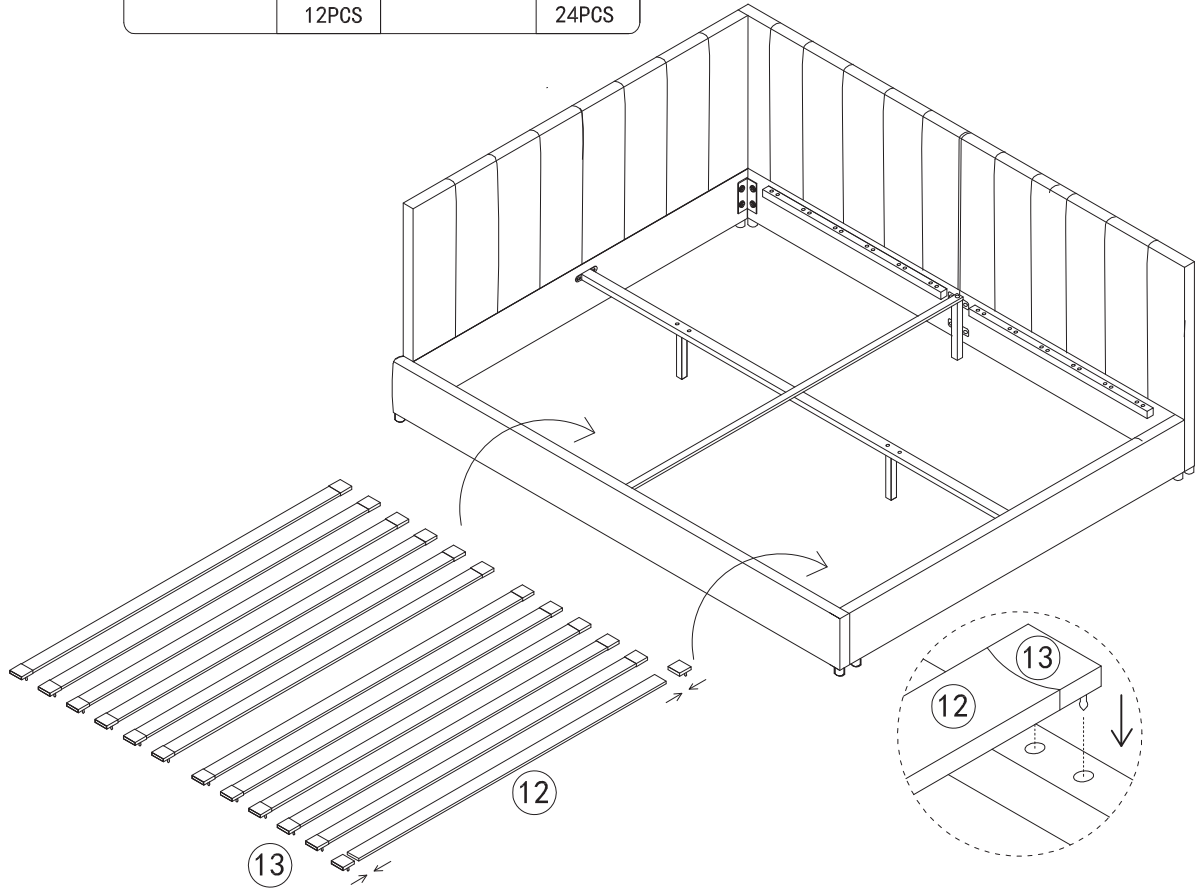

STEP 10

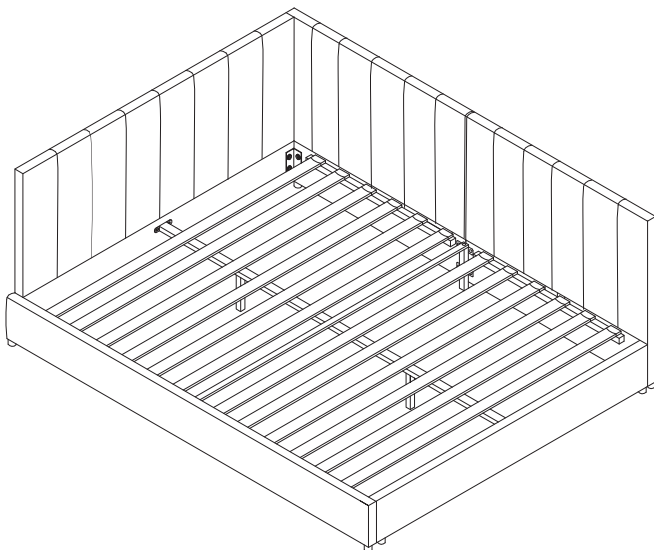

Option L

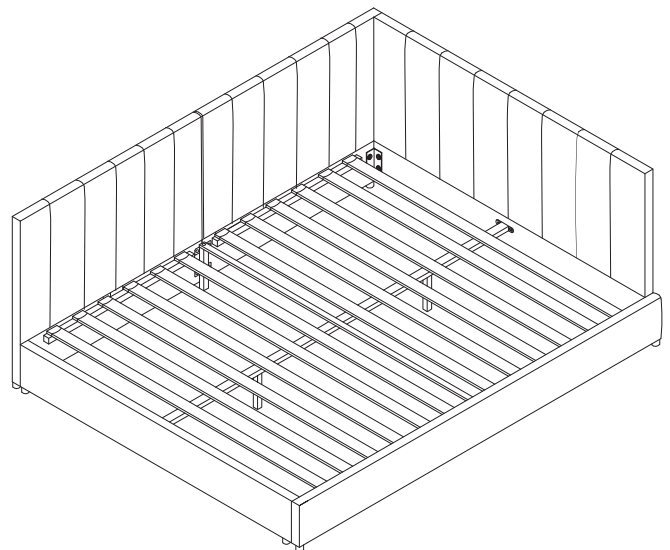

Option R