

CS1901-24

Specifications & Dimension

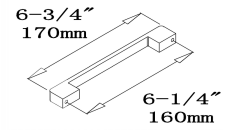

Handle's Dimension

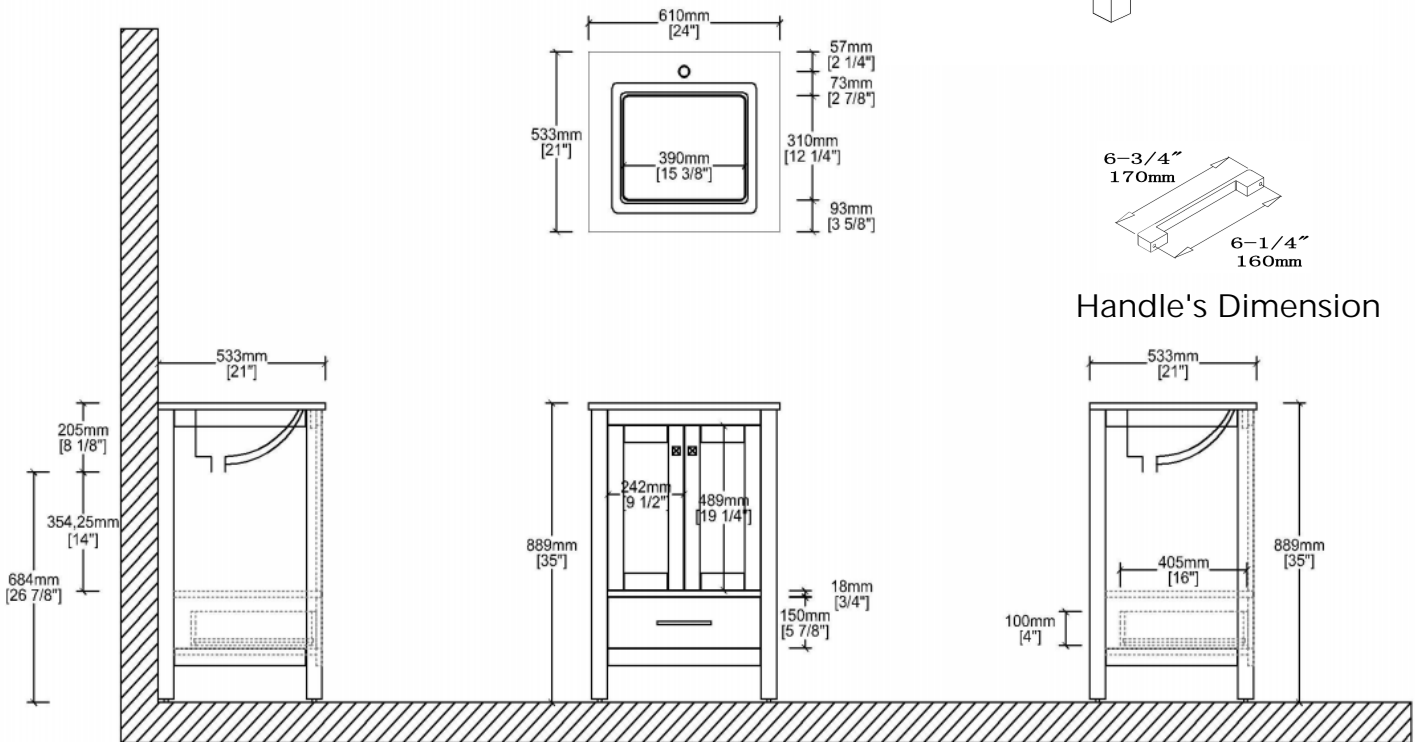
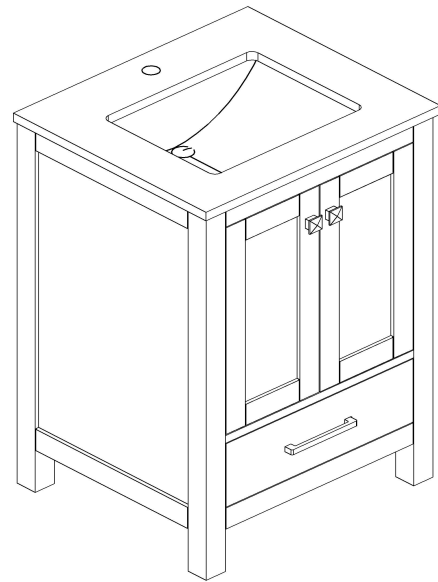