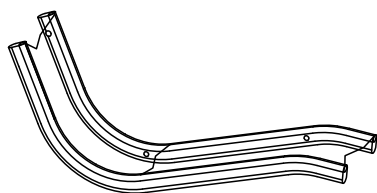
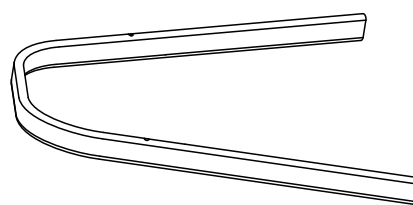
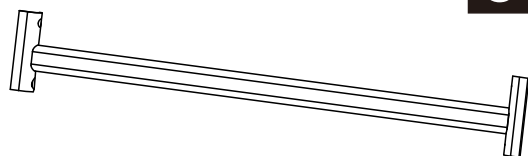
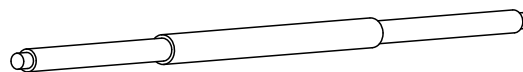
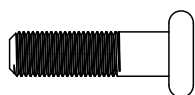
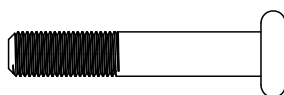
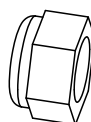
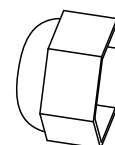
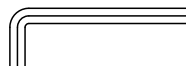
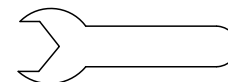

PARTS

**A** x 4**B** x 8**C** x 8**D** x 4

HARDWARE

**E** x16
M6*53**F** x16
M6*72**G** x64**H** x16**I** x32**N** x32**W** x32**X** x 1**Y** x 1

EN Do not tighten bolts fully until all parts are connected!

FR Ne serrez pas les boulons à fond tant que toutes les pièces ne sont pas connectées!

ES No apriete los tornillos completamente hasta que todas las partes están conectadas!

PT Não apertar completamente os parafusos até que todas as peças estejam encaixadas!

DE Ziehen Sie die Schrauben erst fest an, wenn alle Teile verbunden sind!

IT non serrare completamente i bulloni fino a tutte le parti non sono ancora collegate!

NOTE

E x 4
M6*53

G x 8

I x 4

N x 4

W x 4

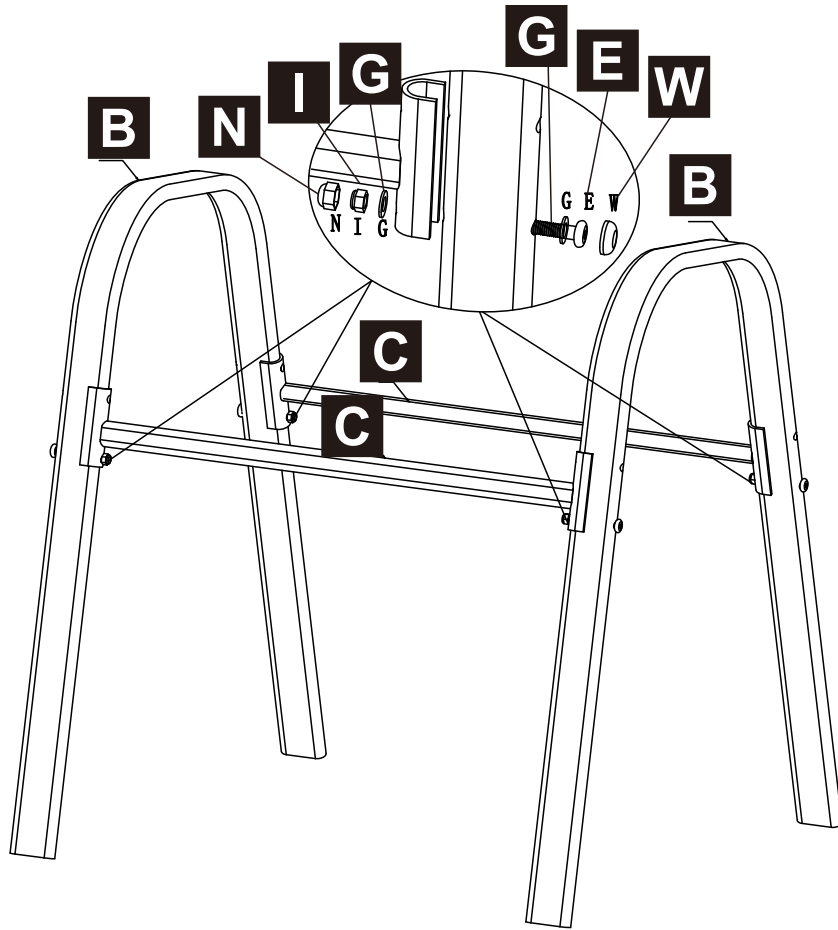

x4

F x 4
M6*72

G x 8

H x 2

I x 4

N x 4

W x 4

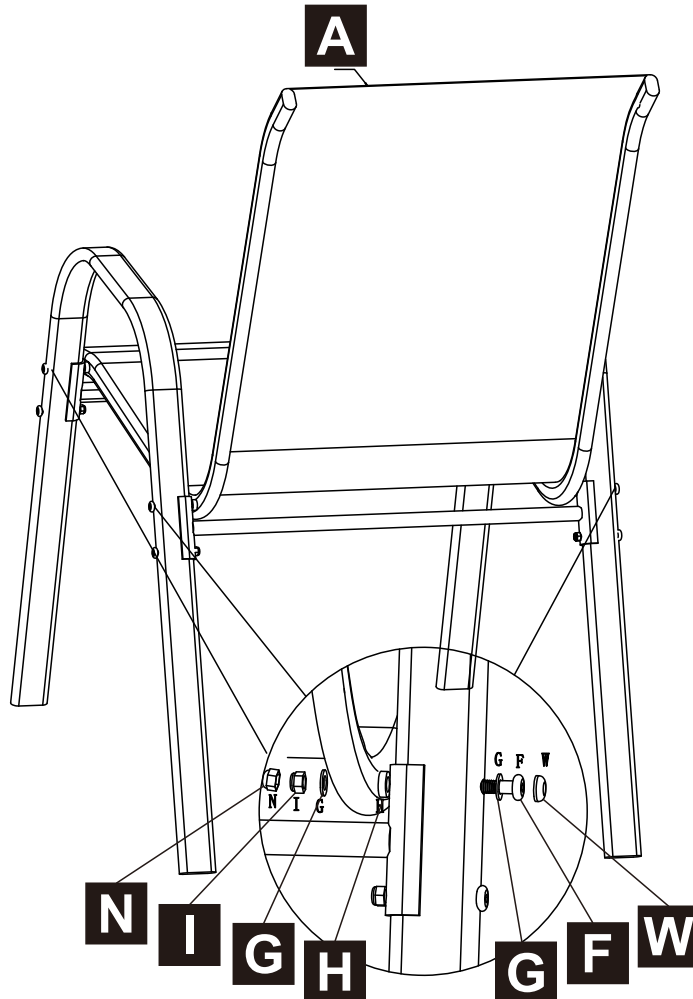

x4

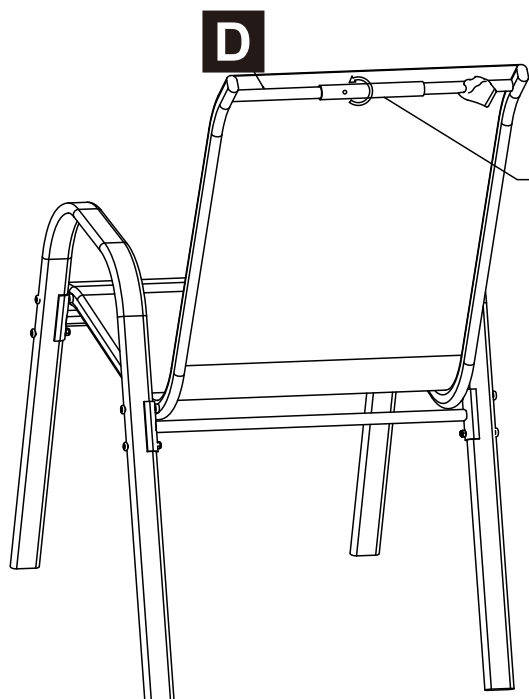

EN One hand to hold the tube, and the other hand to follow the direction to rotate the tube

FR Une main pour tenir le tube, l'autre pour suivre le sens de rotation du tube.

ES Una mano para sujetar el tubo y la otra para seguir la dirección de rotación del tubo

PT Uma mão para segurar o tubo e a outra mão para seguir a direção de rotação do tubo

DE Eine Hand hält das Rohr und die andere Hand folgt der Richtung, in die das Rohr gedreht wird.

IT Una mano per tenere il tubo e l'altra per seguire la direzione di rotazione del tubo.

x4

Done

