

# ASSEMBLY INSTRUCTIONS

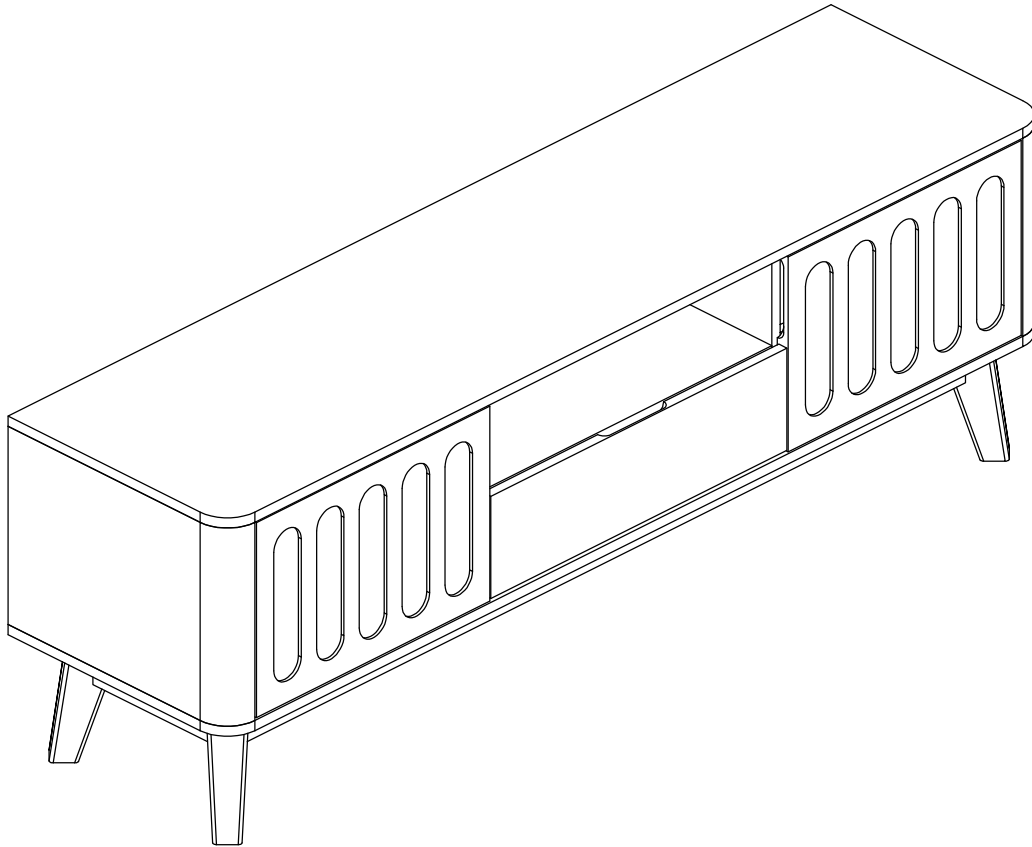

## Notice:

1. Follow the installation instructions. Please confirm all accessories are preset before installation.
2. Do not fully tighten the screws during initial assembly. Fully tighten screws only once all pieces which are correctly assembled.
3. If you encounter any problems during installation, please contact our customer service.
4. Please unbox the item from the side with an open-label and put a carpet on the floor to avoid scratching it.

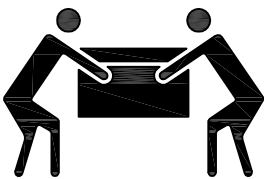

**Recommended installers:2**

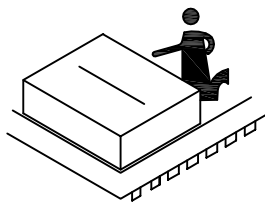



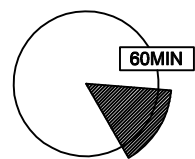





**Put a carpet on the floor  
before unpacking**

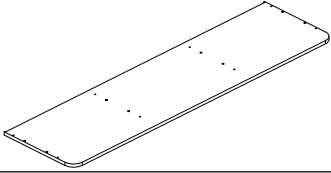

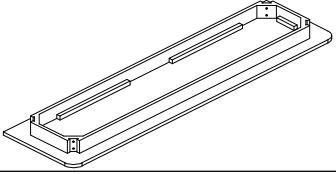
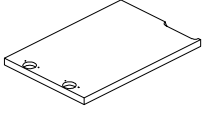
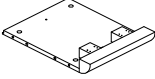
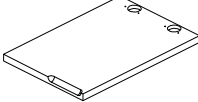
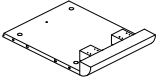
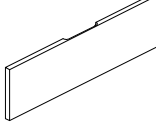
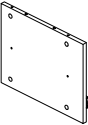
**Estimate installation time:  
60minutes**

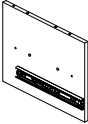

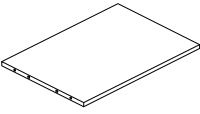

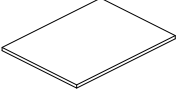
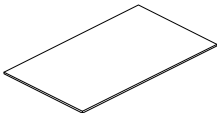
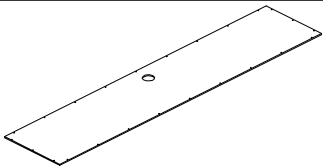
# ASSEMBLY INSTRUCTIONS

## PART LIST

Item no.	Reference Image	Qty	Item no.	Reference Image	Qty
(A)		X1	(J)		X4
(B)		X1	(K)		X1
(C)		X1	(L)		X1
(D)		X1	(M)		X1
(E)		X1	(N)		X1
(F)		X1	(O)		X1
(G)		X1	(P)		X1
(H)		X2	(Q)		X1
(I)		X1			

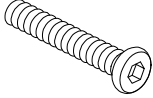
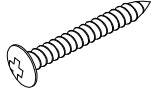
# ASSEMBLY INSTRUCTIONS

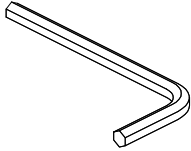
## HARDWARE LIST

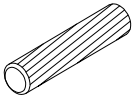
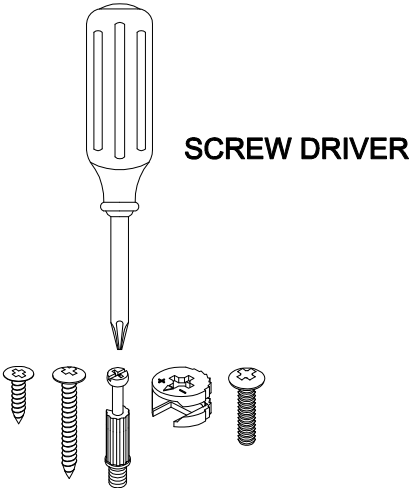
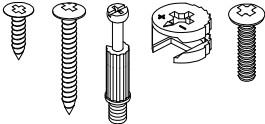
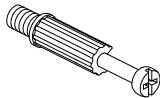
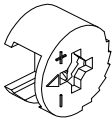
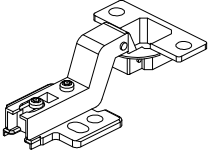
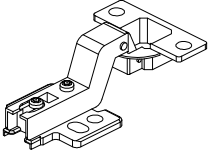
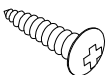
Item no.	Reference Image	Qty	Item no.	Reference Image	Qty
1	 Ø1/4"x2"	X8	11	 Ø7xØ3.5x30 mm	X8
2		X8	12		X1
3		X8			
4		X20+2	<p><b>The following tools are needed. But not included.</b></p>  <p>SCREW DRIVER</p>		
5		X20+2			
6		X20+2			
7		X8			
8		X4			
9	 Ø6.5xØ3x14 mm	X24+2			
10	 Ø6.5xØ3x15 mm	X24+2			

# ASSEMBLY INSTRUCTIONS

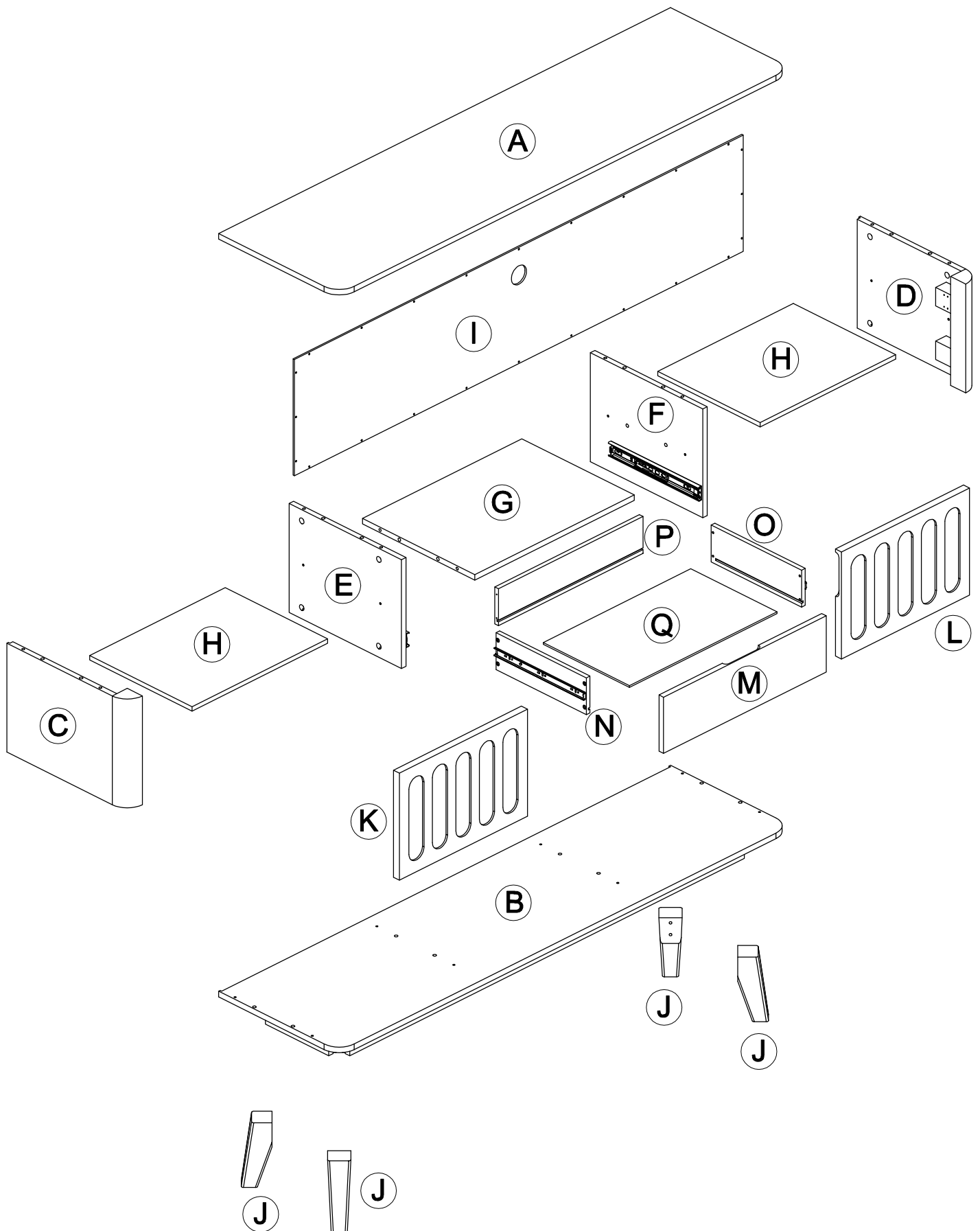

# ASSEMBLY INSTRUCTIONS

1

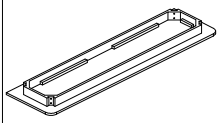

B 1pc



J 4pc

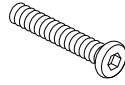

1 8pc



2 8pc



3 8pc

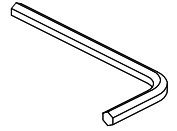

12 1pc

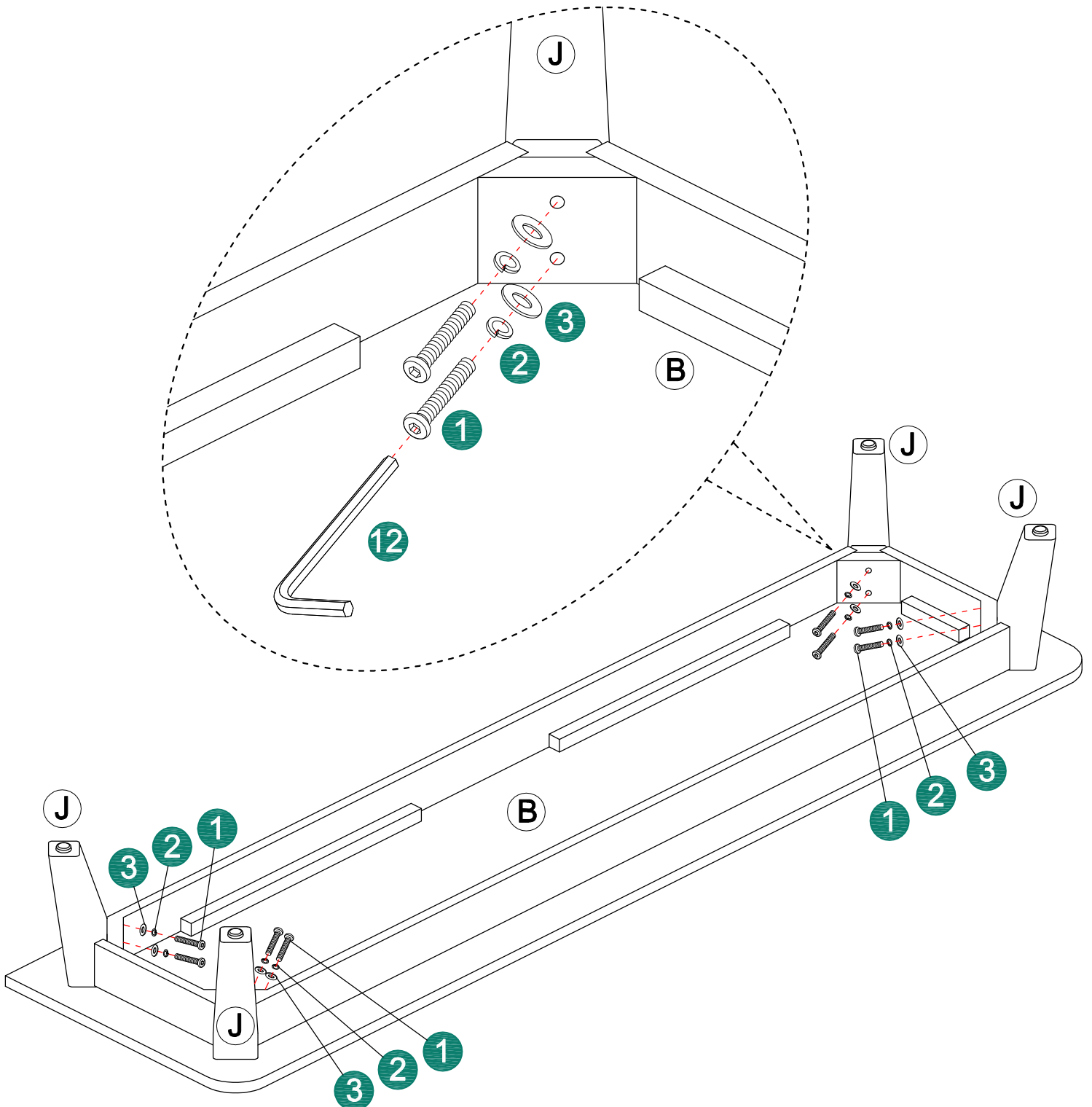

# ASSEMBLY INSTRUCTIONS

2

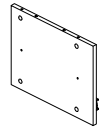

E 1pc

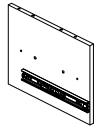

F 1pc

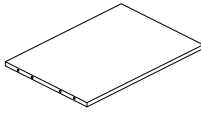

G 1pc

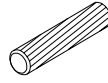

4 4pc

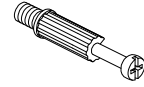

5 4pc



6 4pc

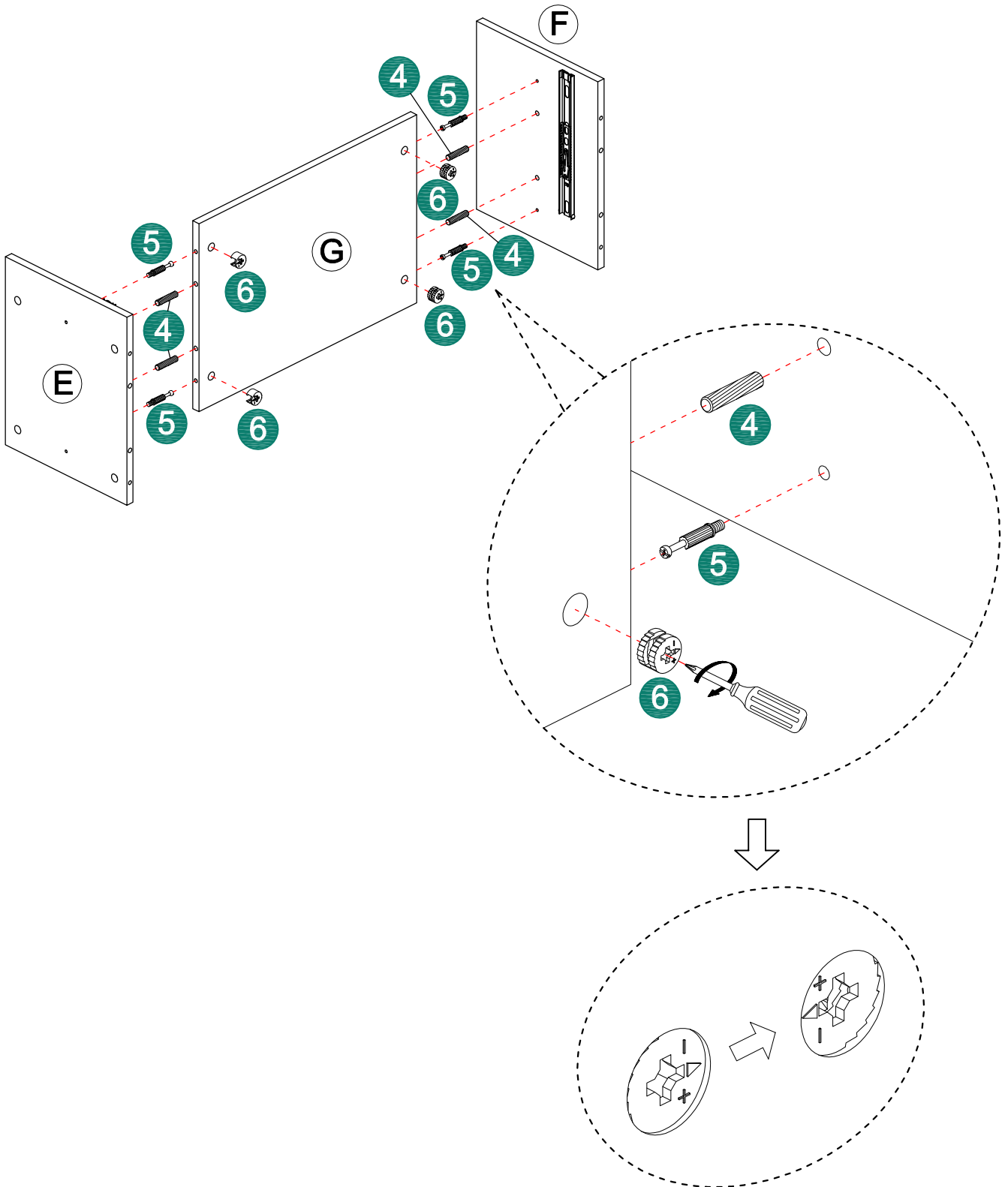

# ASSEMBLY INSTRUCTIONS

3

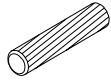

4 4pc

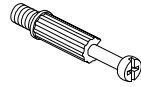

5 4pc



6 4pc

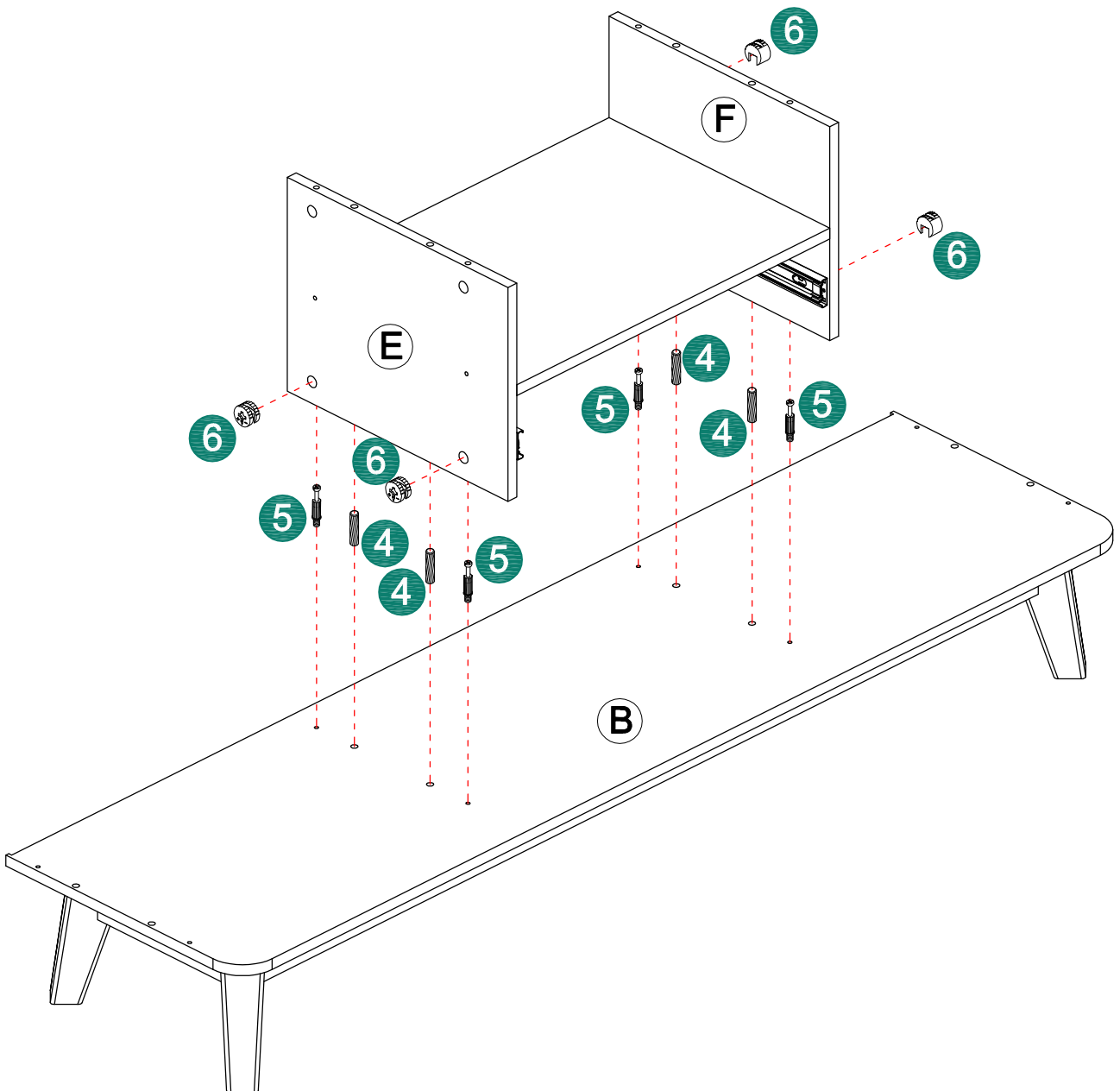

# ASSEMBLY INSTRUCTIONS

4

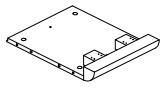

C 1pc

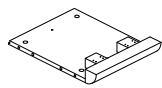

D 1pc

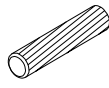

4 4pc

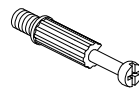

5 4pc



6 4pc

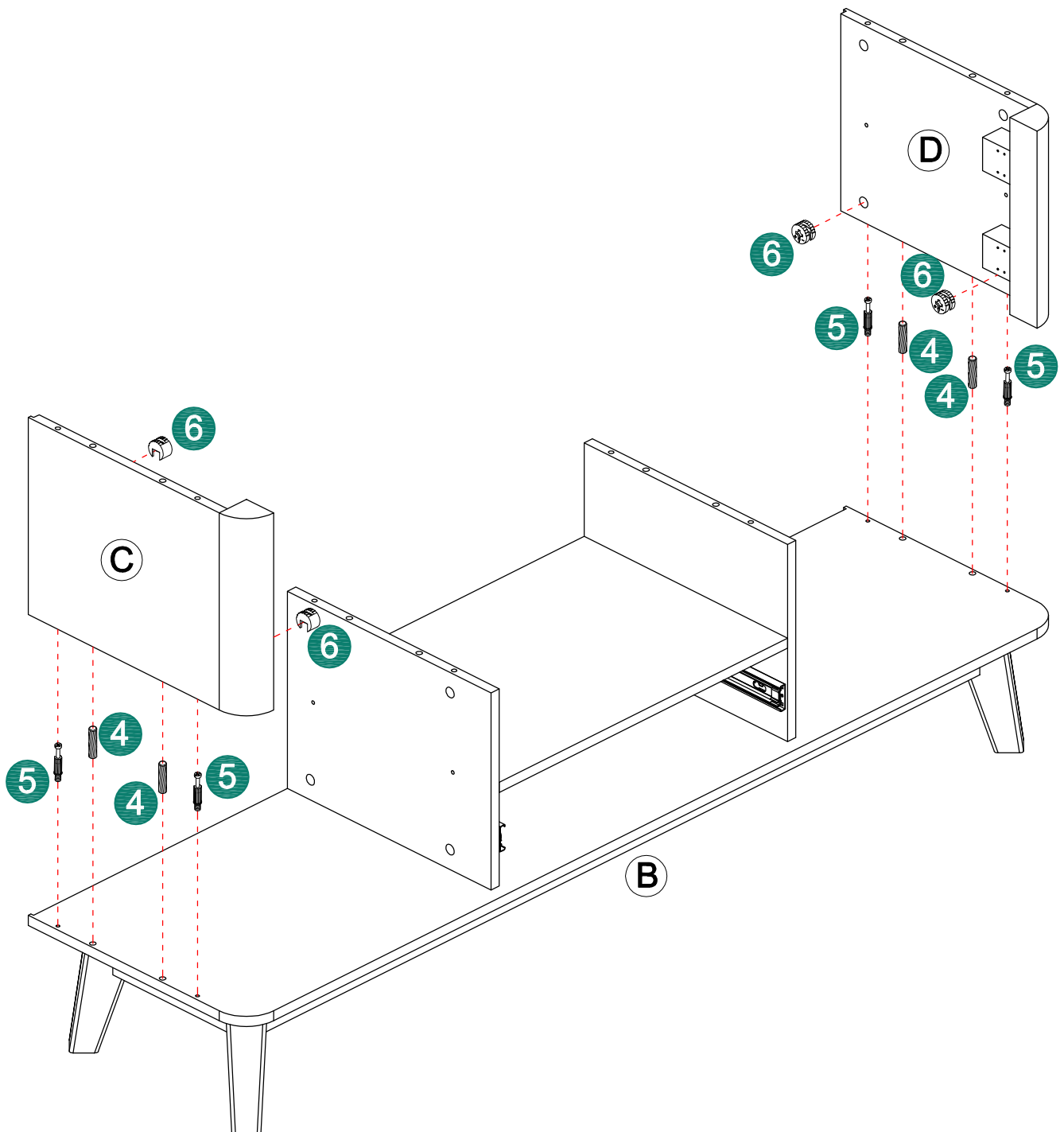

# ASSEMBLY INSTRUCTIONS

5

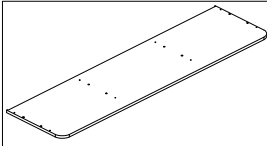

A 1pc

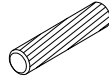

4 8pc

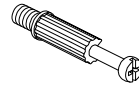

5 8pc



6 8pc

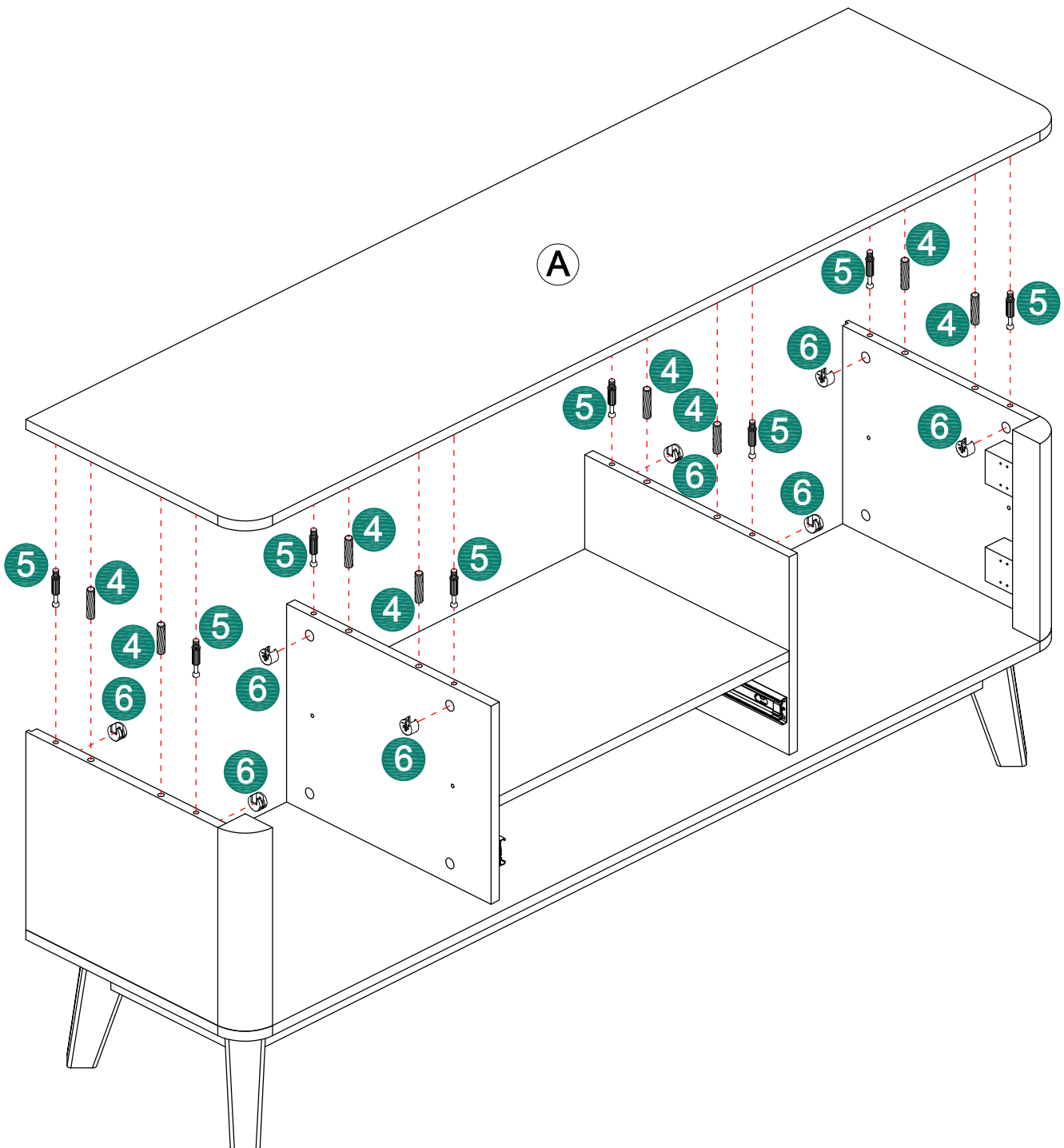

# ASSEMBLY INSTRUCTIONS

6

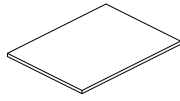

(H) 2pc



(7) 8pc

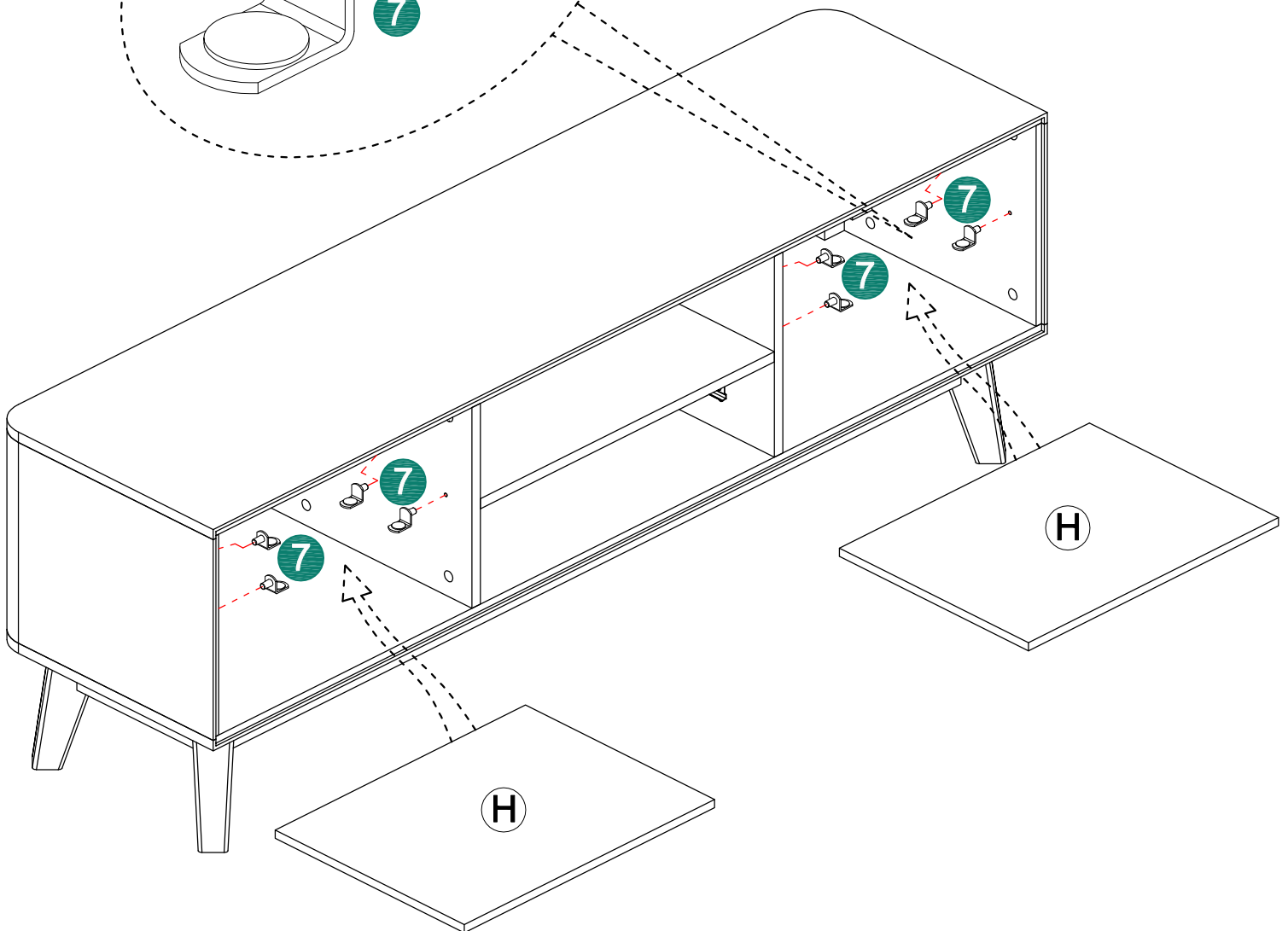
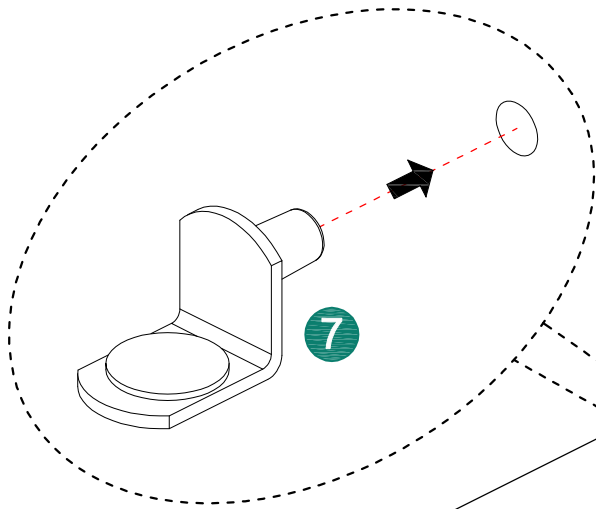

# ASSEMBLY INSTRUCTIONS

7

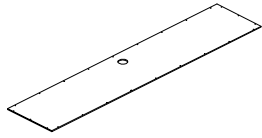

1 1pc



10 24pc

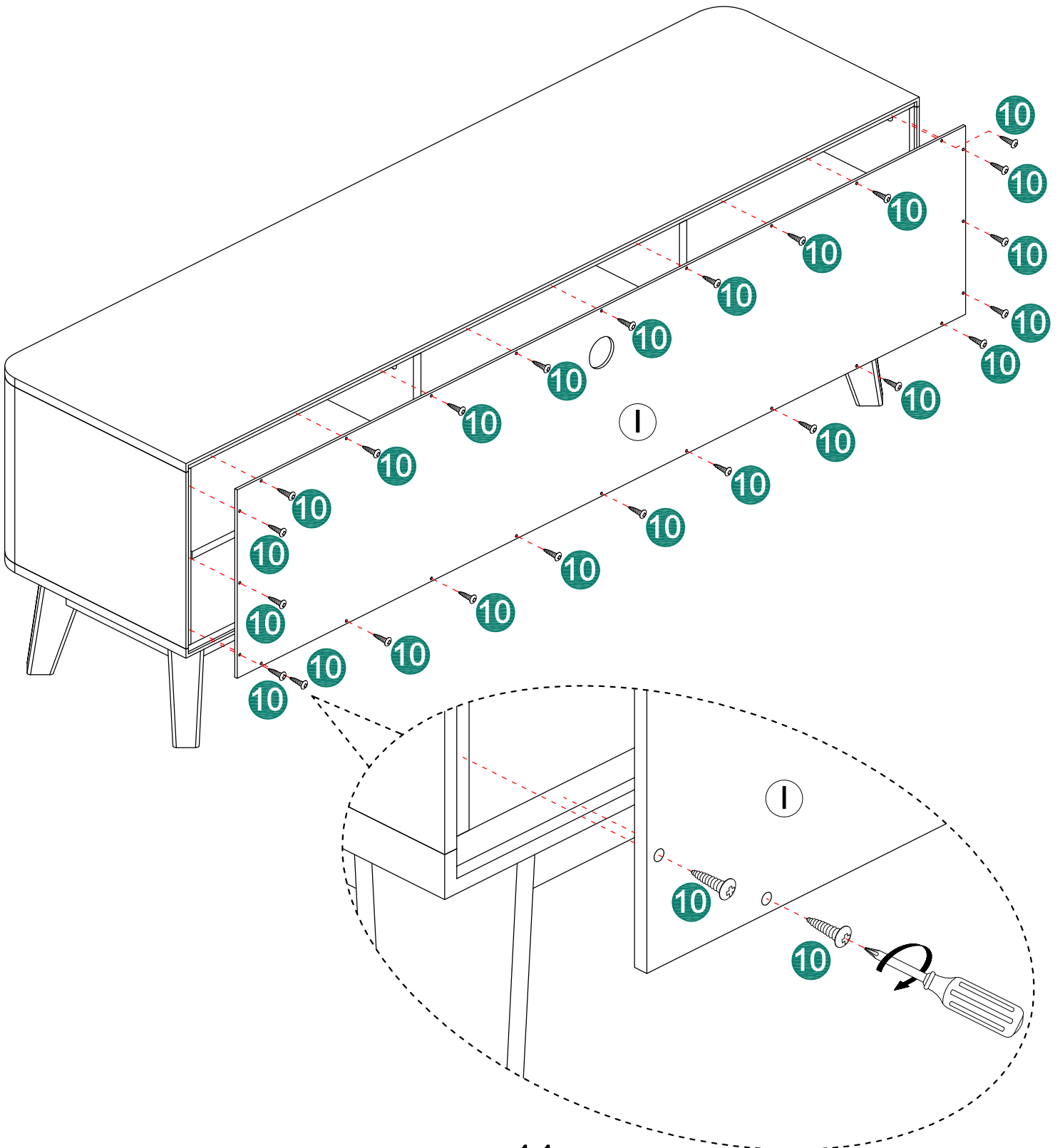

# ASSEMBLY INSTRUCTIONS

8

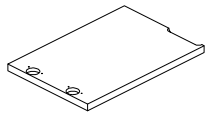

K 1pc

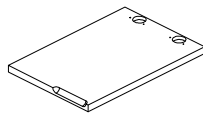

L 1pc

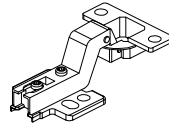

8 4pc



9 24pc

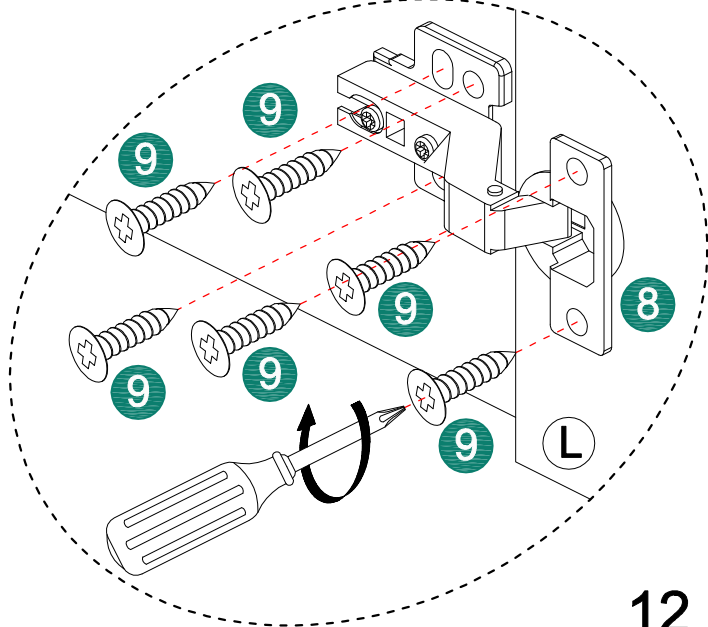
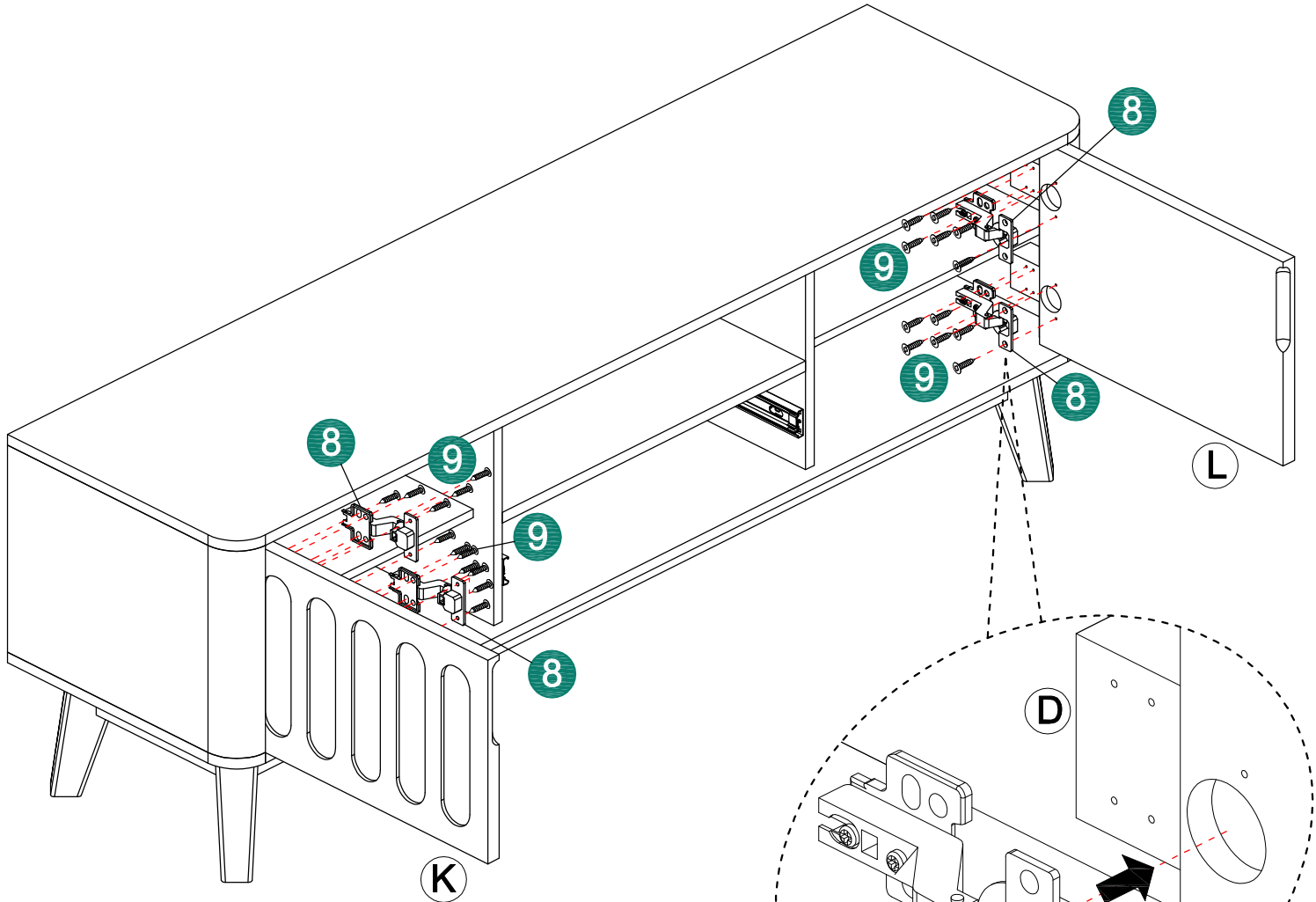

# ASSEMBLY INSTRUCTIONS

9

## FRONT VIEW

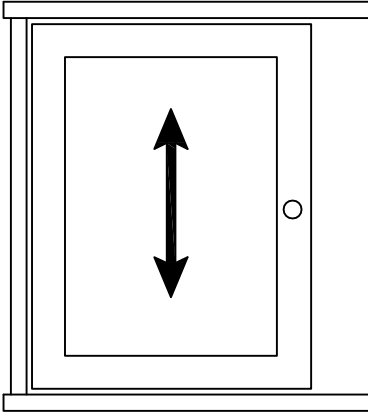

**UP AND DOWN**  
Use screws to adjust the gaps  
at the top and bottom of door.

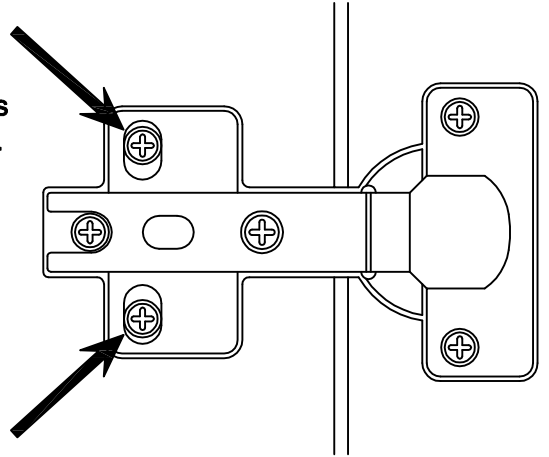

## FRONT VIEW

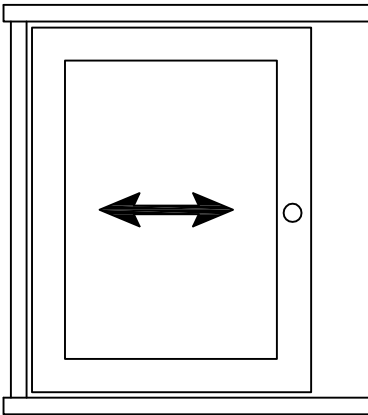

**LEFT AND RIGHT**  
Use screw to adjust the gaps  
at left and right of the door.

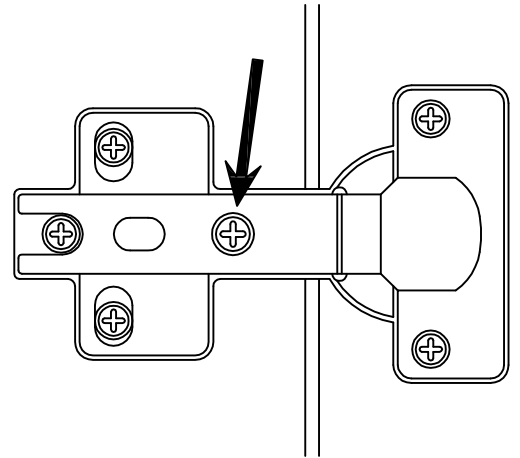

## TOP VIEW

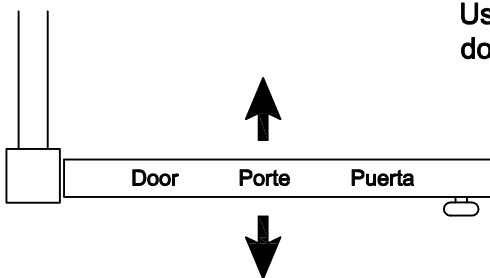



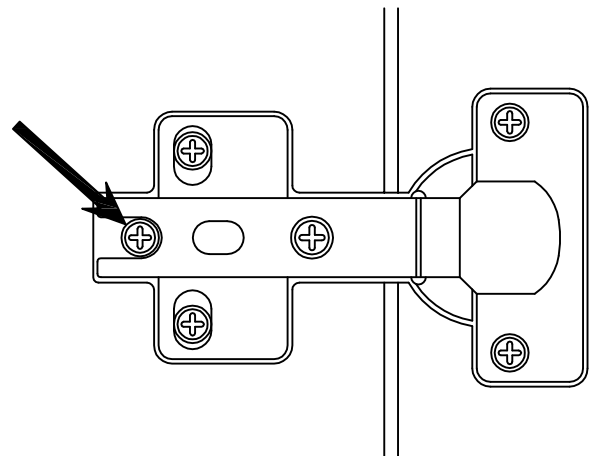

**IN AND OUT**  
Use screw to move the  
door in or out.



# ASSEMBLY INSTRUCTIONS

10

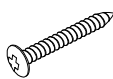
-  N 1pc
-  O 1pc
-  P 1pc
-  Q 1pc
-  11 4pc

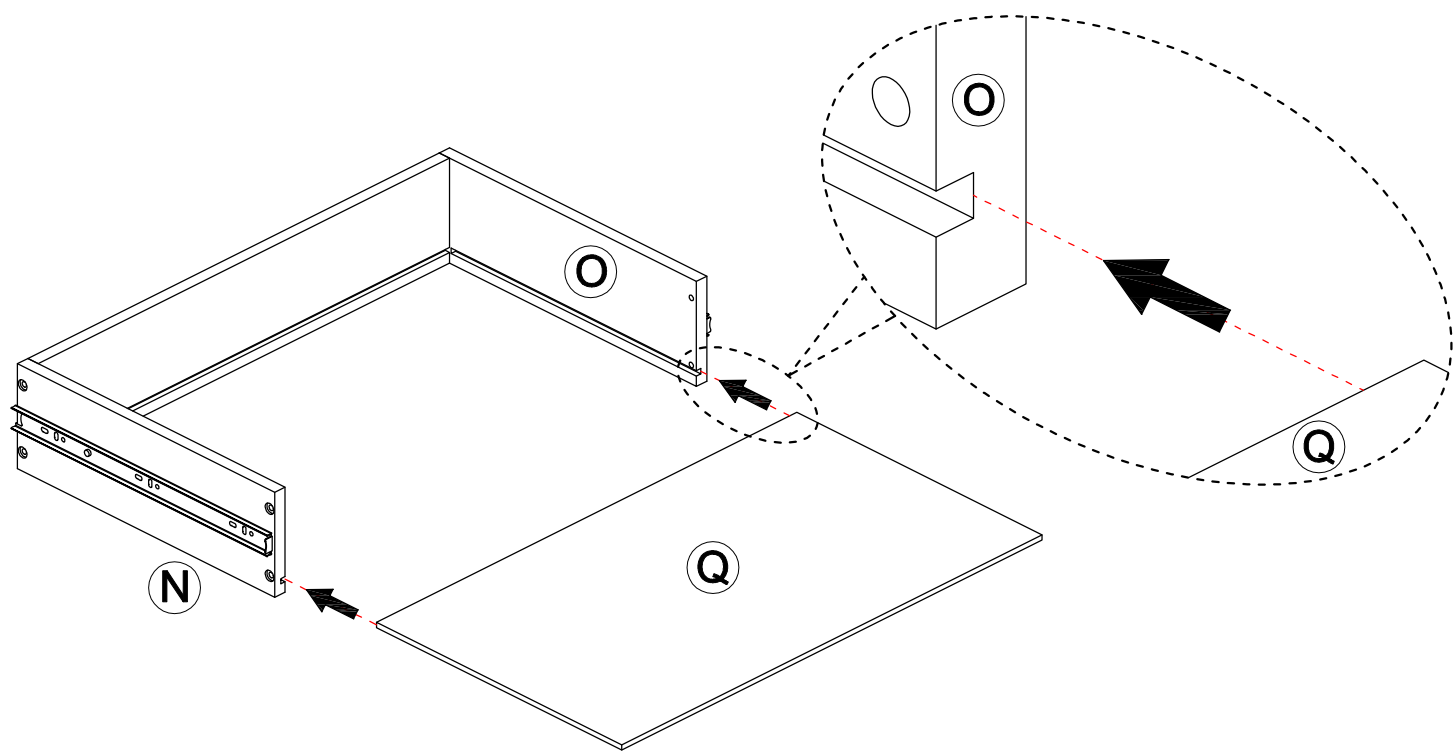
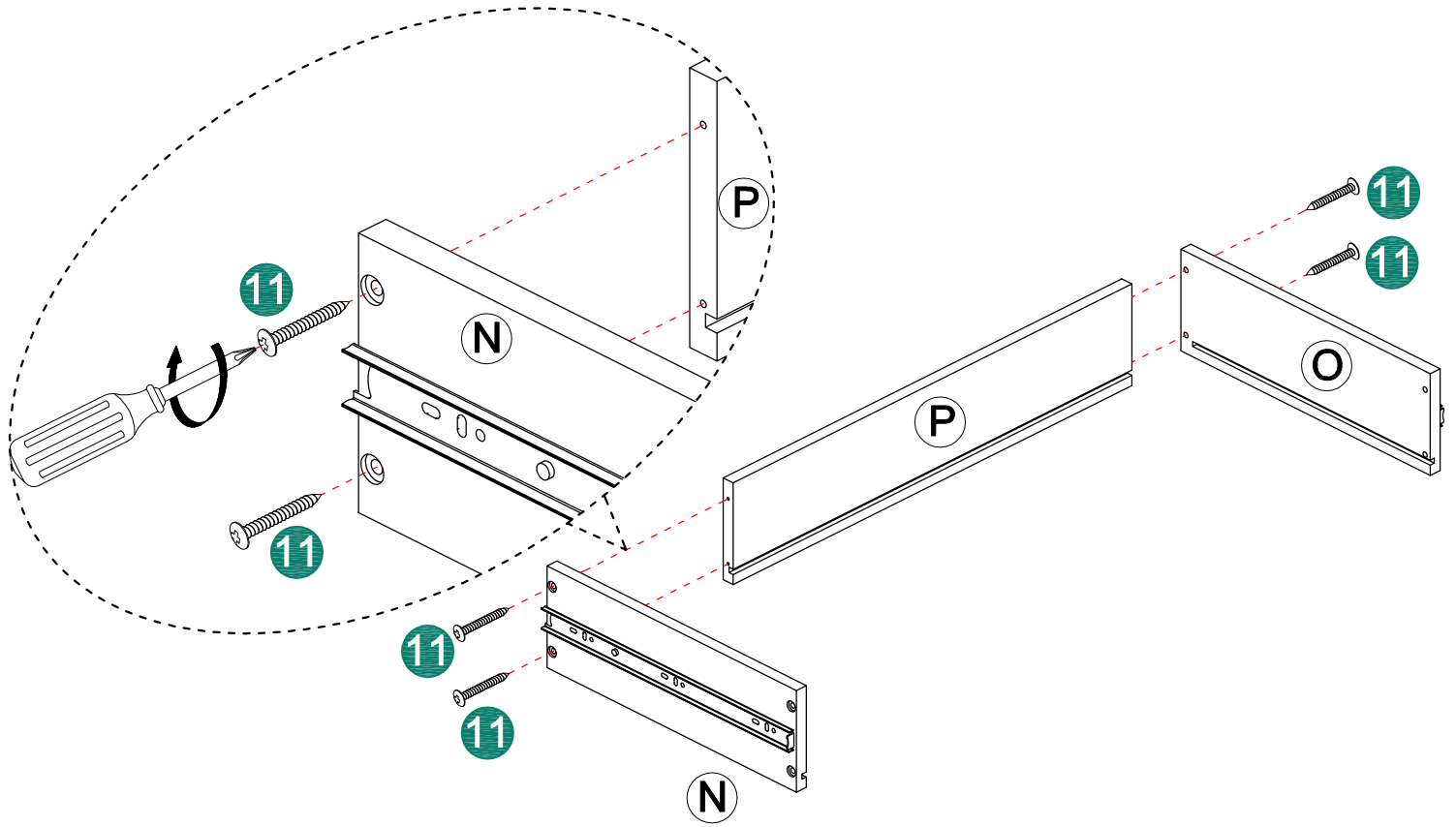

# ASSEMBLY INSTRUCTIONS

11

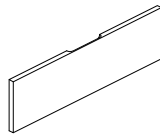

M 1pc

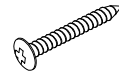

11 4pc

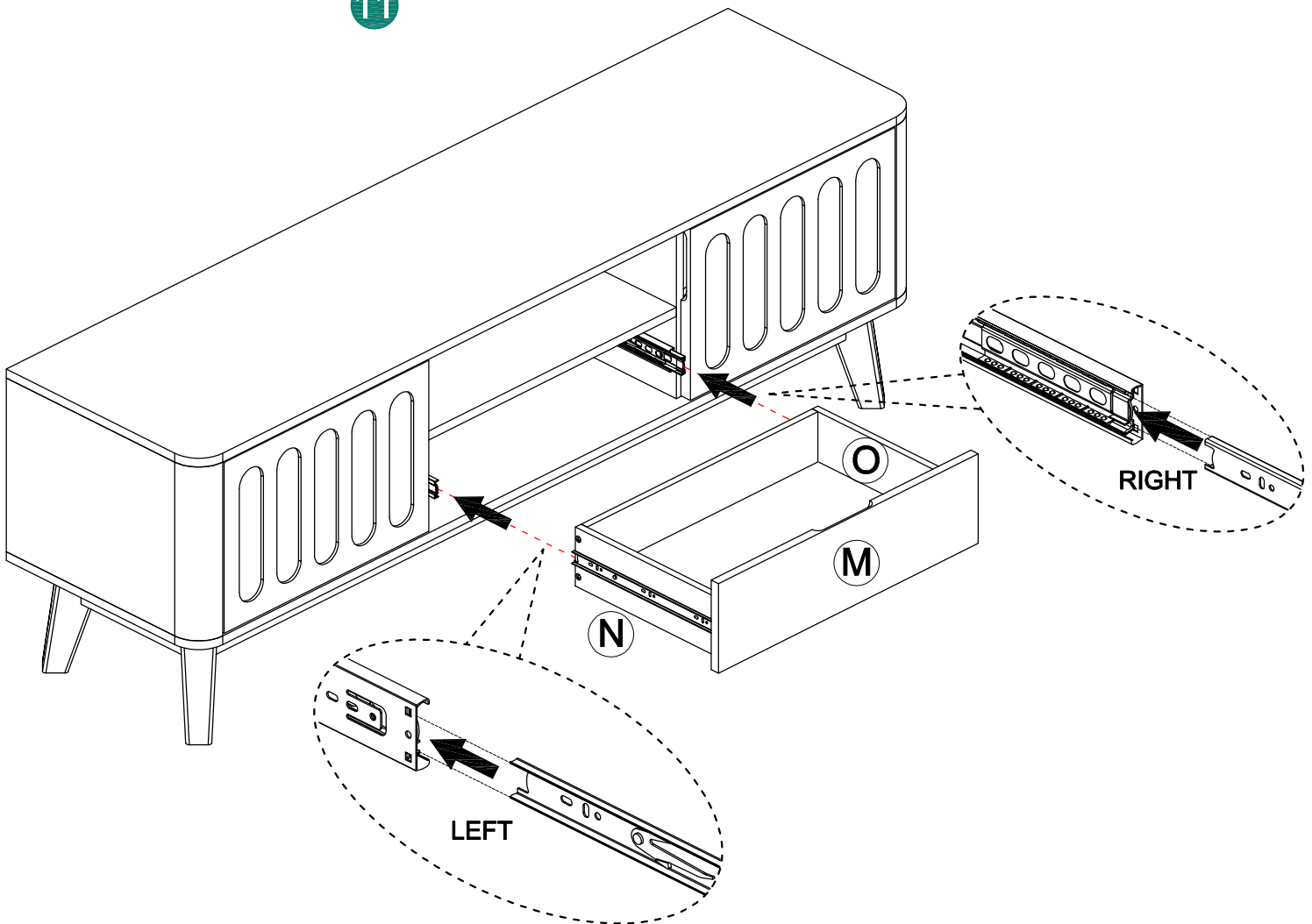
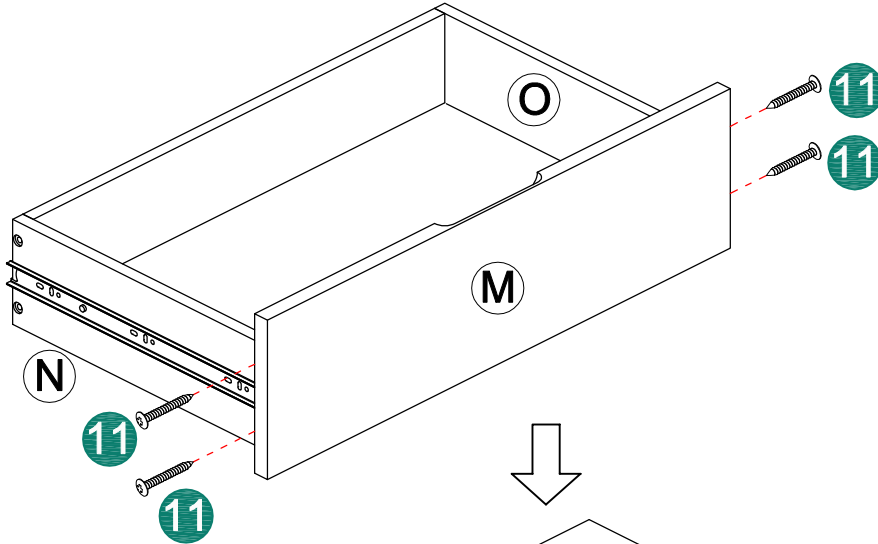

# ASSEMBLY INSTRUCTIONS

12

