

ASSEMBLY INSTRUCTIONS

HYBC-007-B

HYBC-007-W



Notice:

1. Follow the installation instructions. Please confirm all accessories are preset before installation.
2. Do not fully tighten the screws during initial assembly. Fully tighten screws only once all pieces which are correctly assembled.
3. If you encounter any problems during installation, please contact our customer service.
4. Please unbox the item from the side with an open-label and put a carpet on the floor to avoid scratching it.

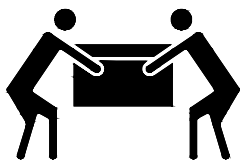

Recommended installers:2

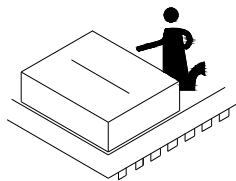

Put a carpet on the floor
before unpacking

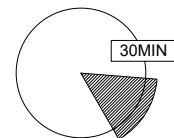

Estimate installation time:
30minutes

ASSEMBLY INSTRUCTIONS

PART LIST

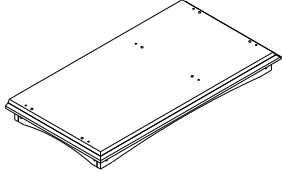
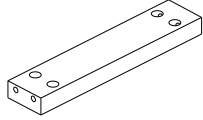
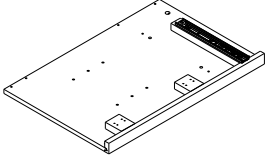
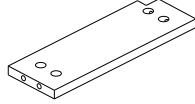
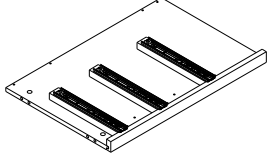
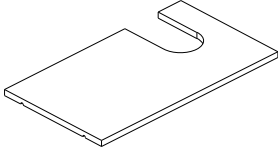
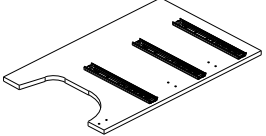
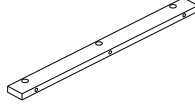
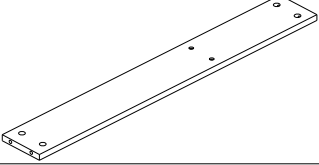
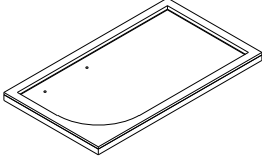
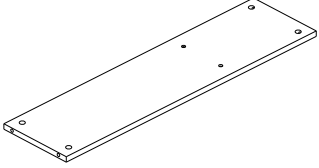
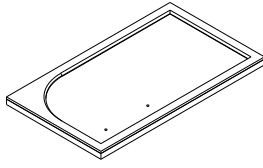
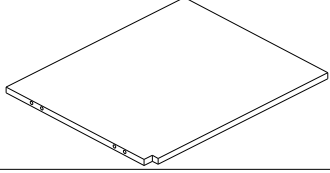
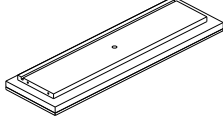
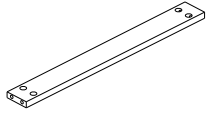
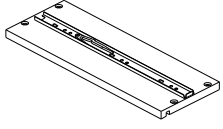
Item no.	Reference Image	Qty	Item no.	Reference Image	Qty
(A)		X1	(I)		X1
(B)		X1	(J)		X2
(C)		X1	(K)		X1
(D)		X1	(L)		X1
(E)		X1	(M)		X1
(F)		X1	(N)		X1
(G)		X1	(O)		X1
(H)		X1	(P)		X3





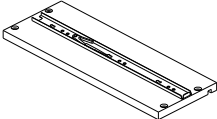
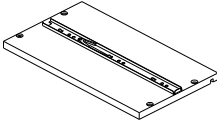
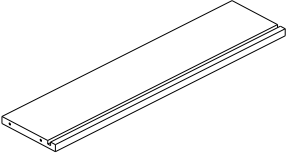
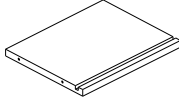
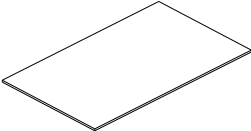
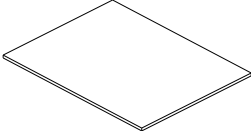
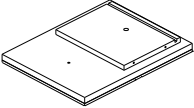
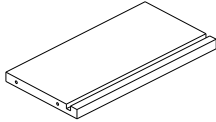
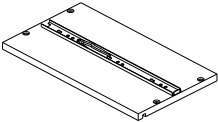
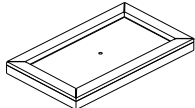
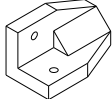



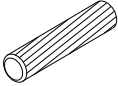

ASSEMBLY INSTRUCTIONS

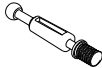
PART LIST

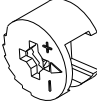
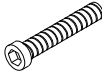
Item no.	Reference Image	Qty	Item no.	Reference Image	Qty
Q		X3	V		X1
R		X1	W		X1
S		X1	X		X3
T		X1	Y		X2
U		X1	Z		X2
			ZZ		X4

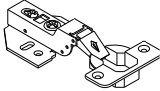
ASSEMBLY INSTRUCTIONS

HARDWARE LIST

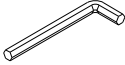
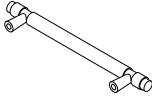
Item no.	Reference Image	Qty	Item no.	Reference Image	Qty
1	 Ø8*30mm	X11+1	9	 Ø5*3/4"	X9
2		X37+3	10		X4
3		X37+3	11	 Ø1/4"*1-1/4"	X8
4	 Ø3.5*30mm	X36+3	12		X8
5		X4	13		X8
6	 Ø3*14mm	X24+2	14		X2
7		X5	15		X1
8		X2			

ASSEMBLY INSTRUCTIONS

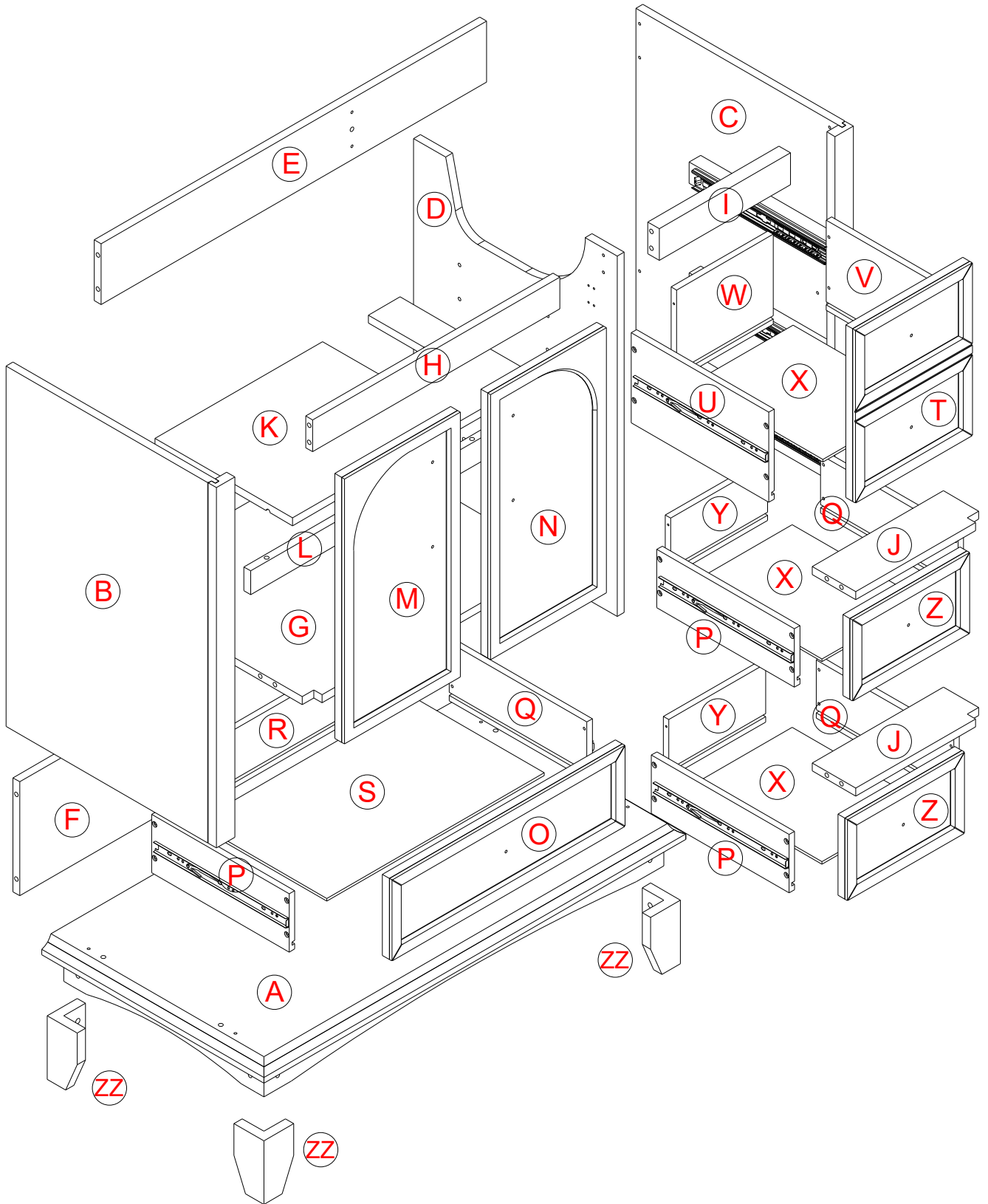

ASSEMBLY INSTRUCTIONS

1

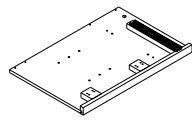

Ⓑ 1PC

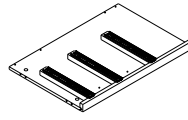

Ⓒ 1PC



② 18PCS

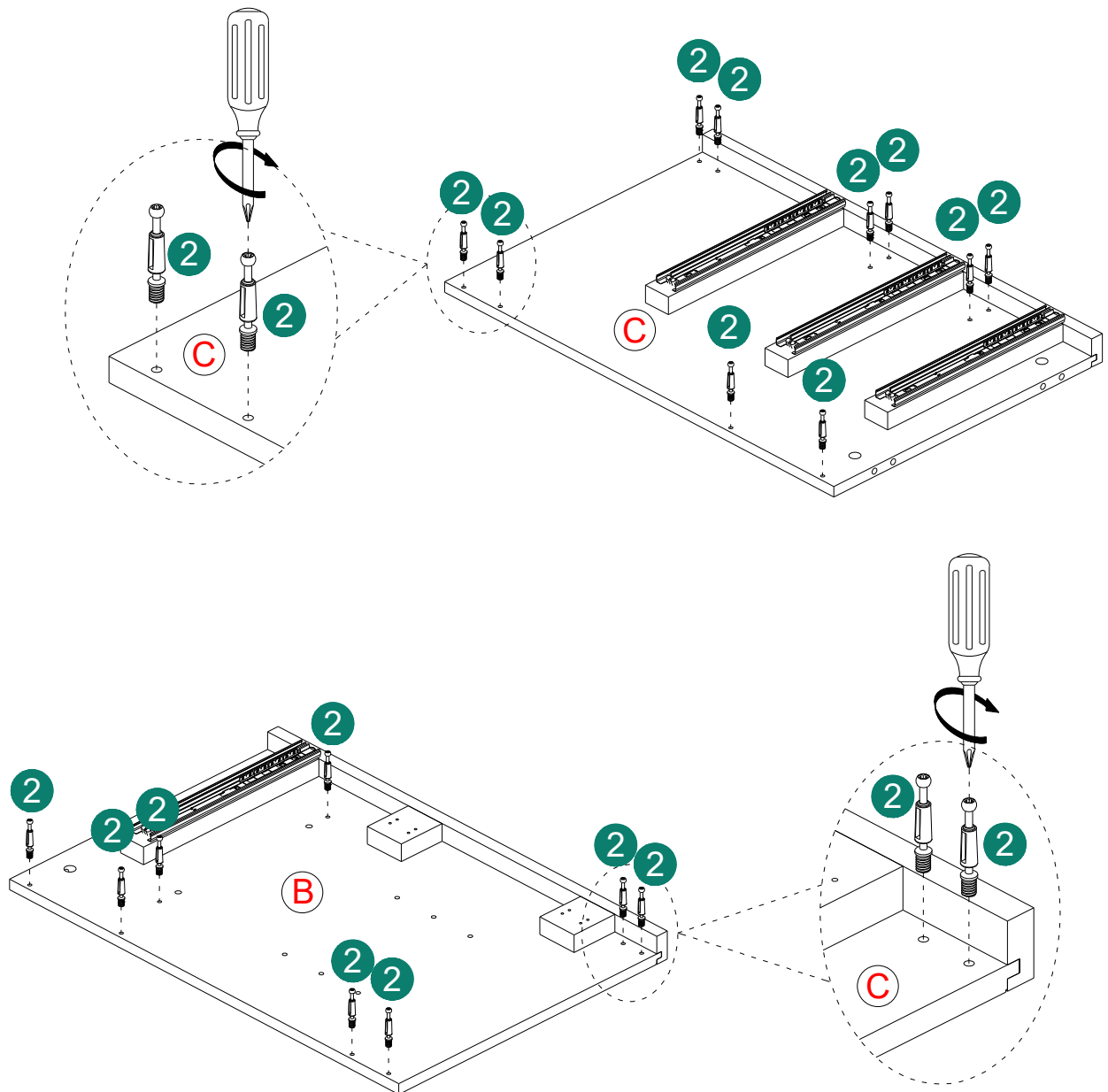

ASSEMBLY INSTRUCTIONS

2

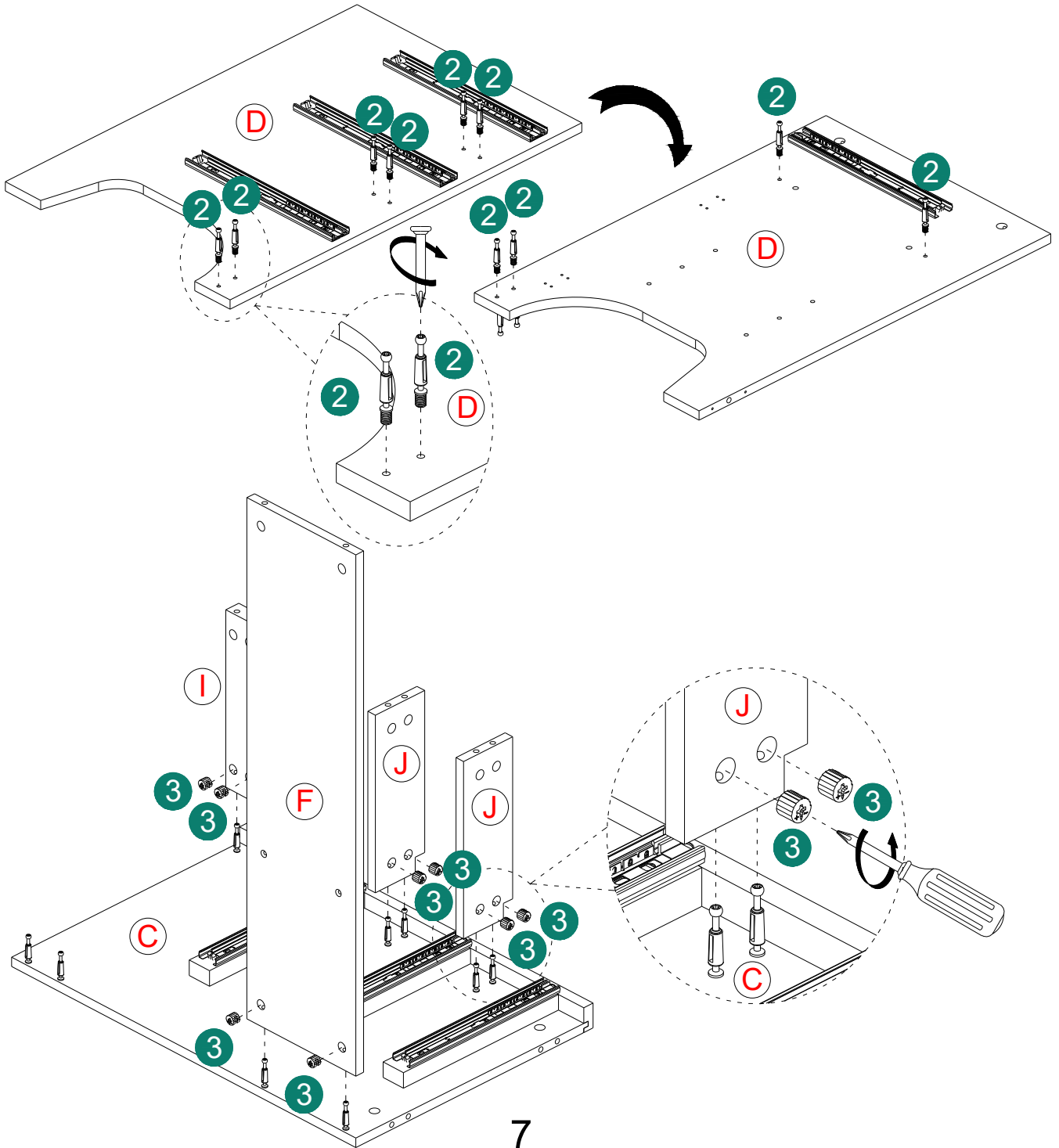
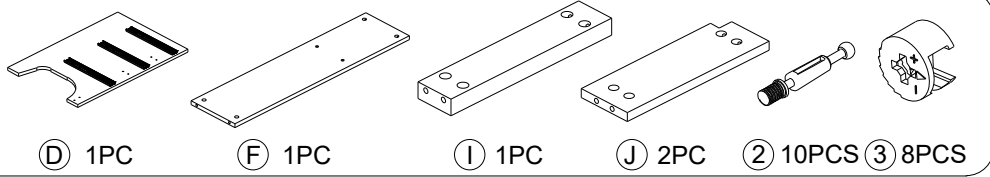

ASSEMBLY INSTRUCTIONS

3

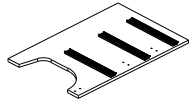

D 1PC

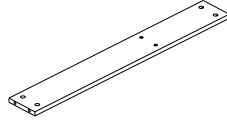

E 4PC



3 8PCS

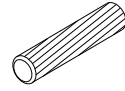

1 1PCS

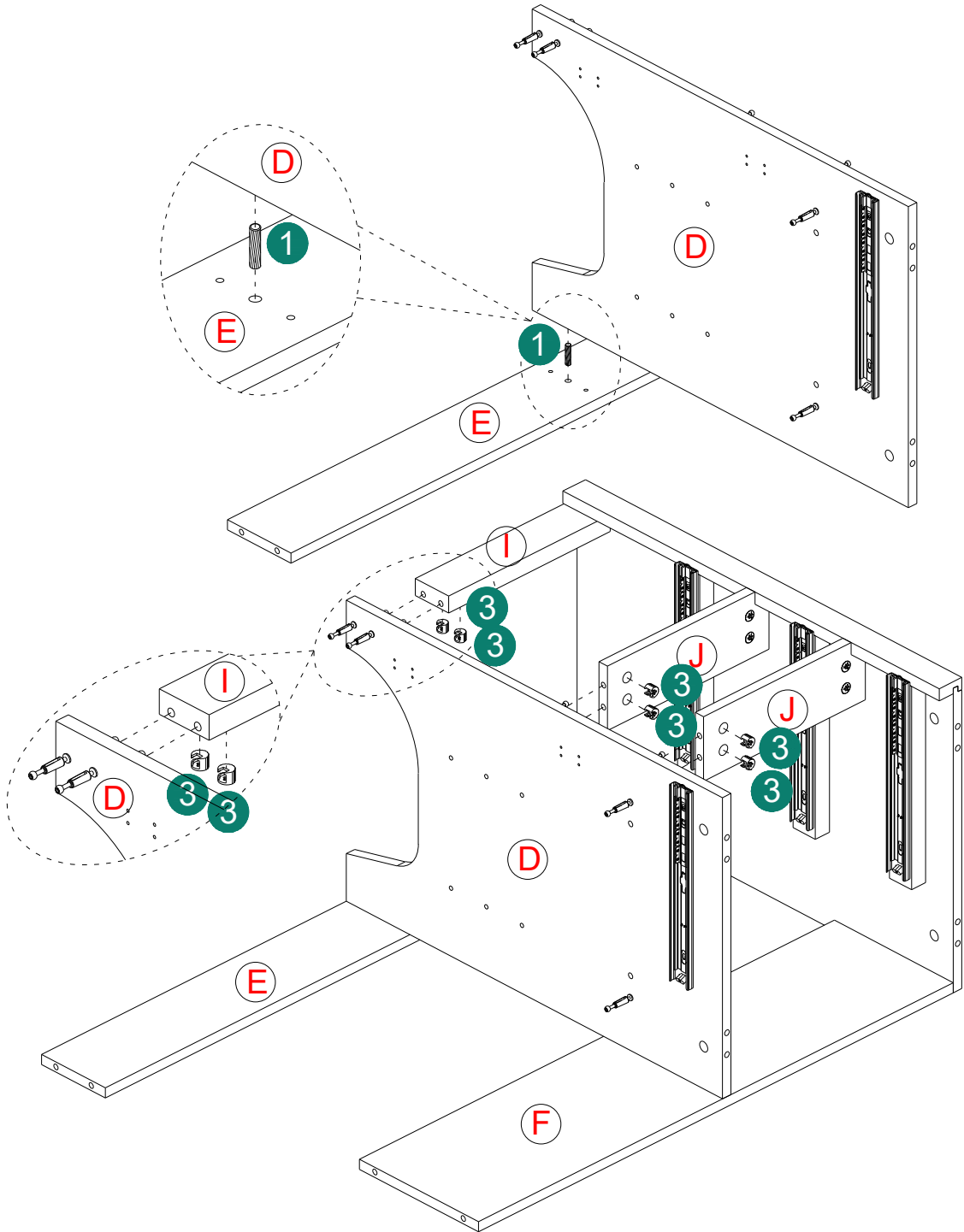

ASSEMBLY INSTRUCTIONS

4

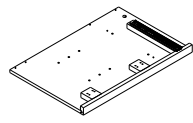

(B) 1PC

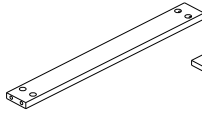

(H) 1PC

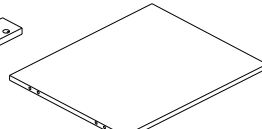

(G) 1PC



(3) 12PCS

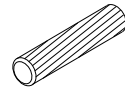

(1) 4PCS

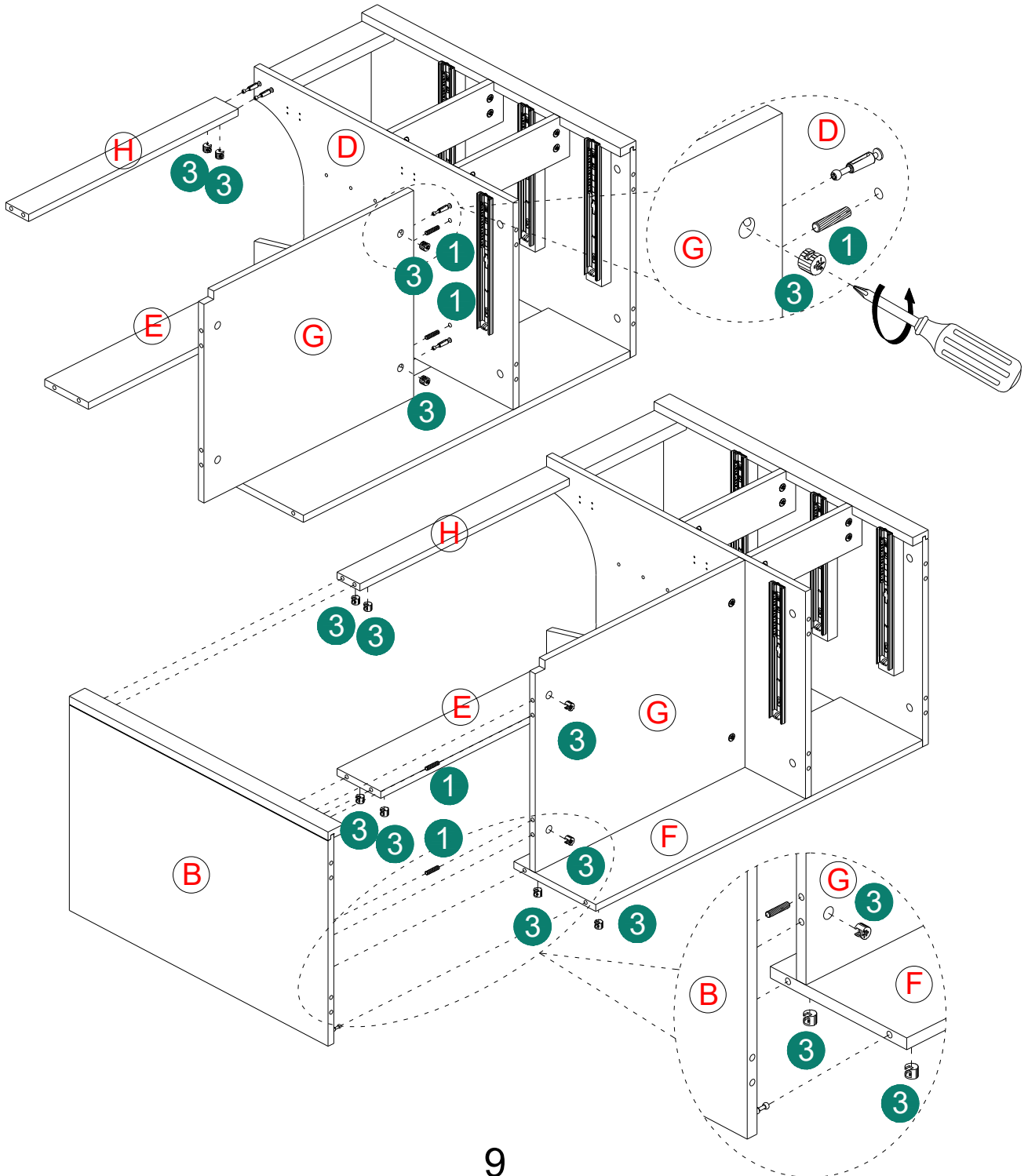

ASSEMBLY INSTRUCTIONS

5

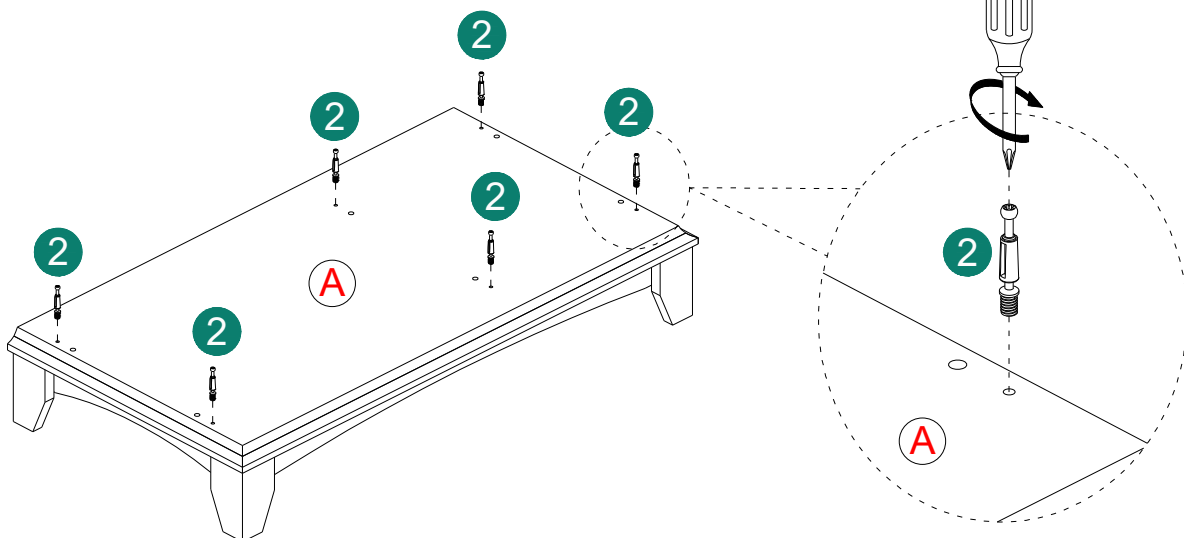
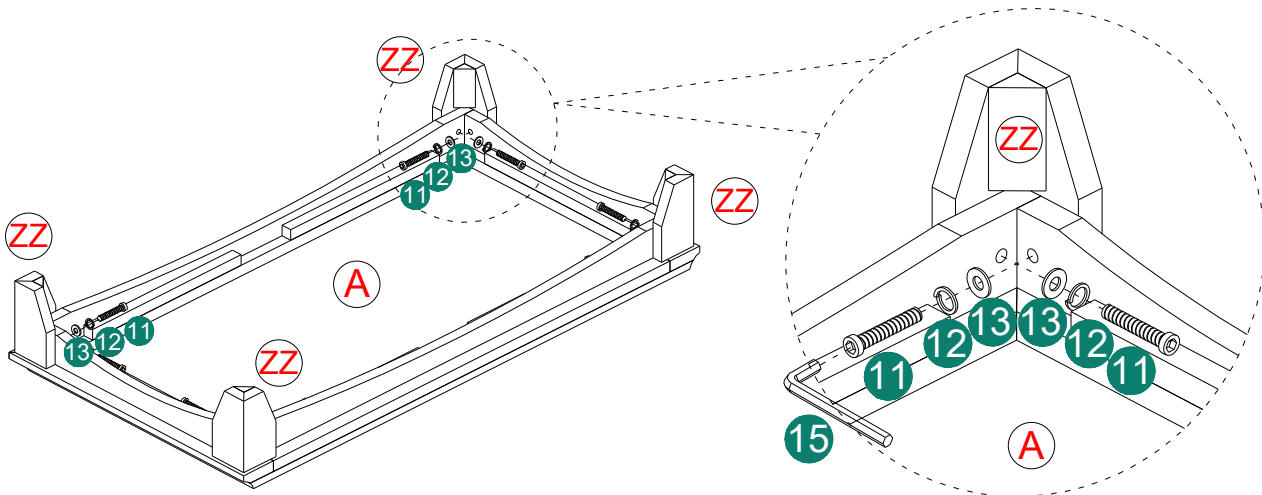
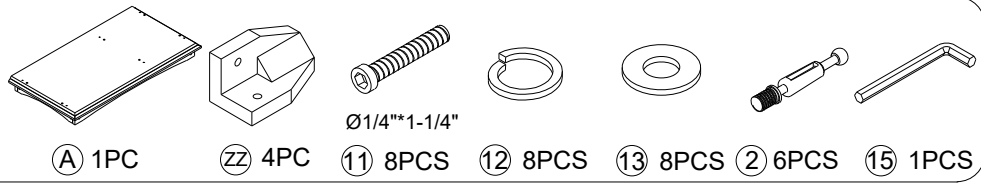

ASSEMBLY INSTRUCTIONS

6



③ 6PCS

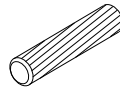

① 6PCS



Ø3.5*30mm

④ 4PCS

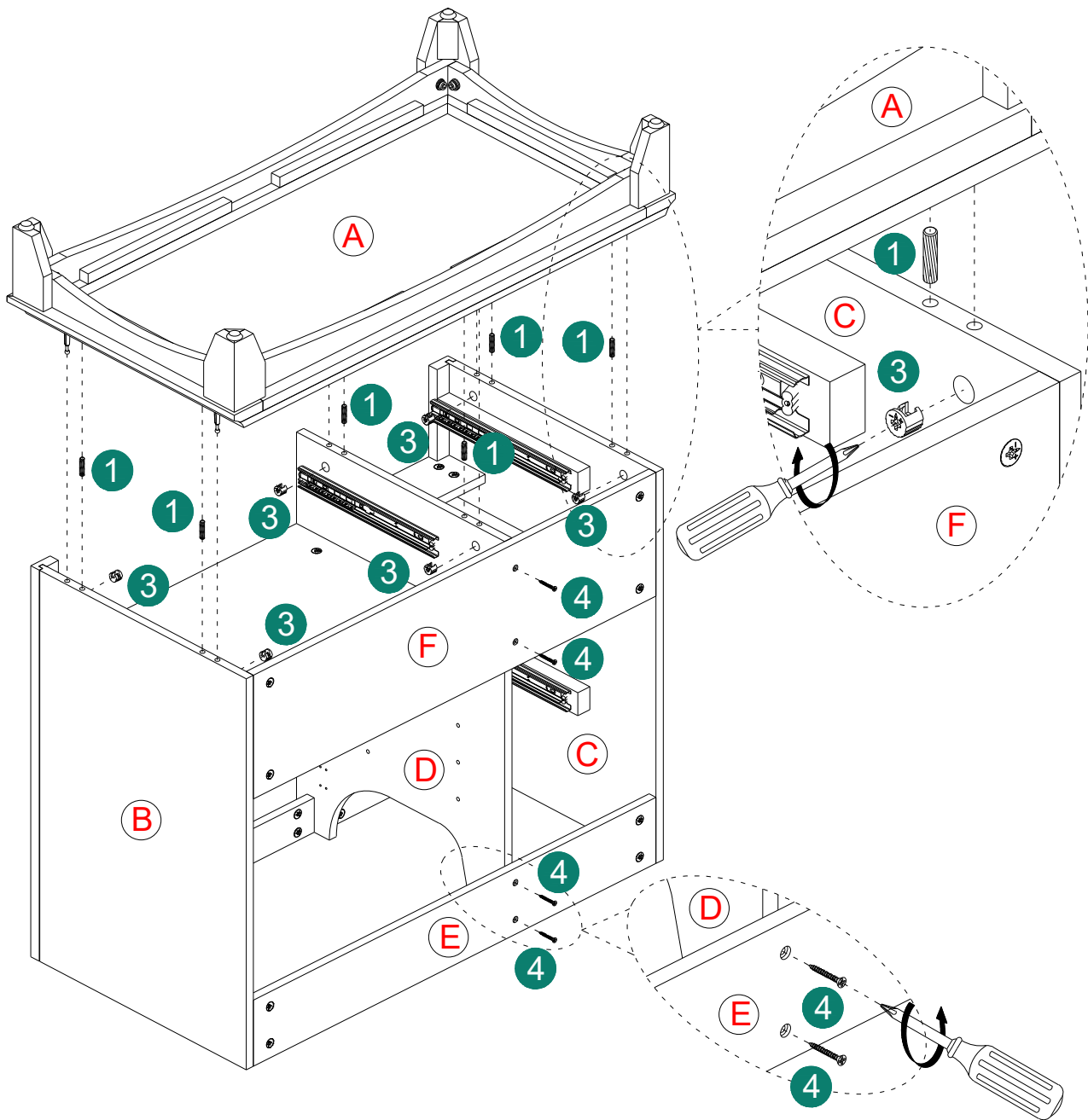

ASSEMBLY INSTRUCTIONS

7

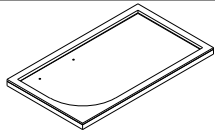

(M) 1PC

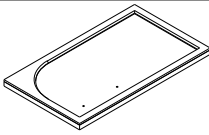

(N) 1PC

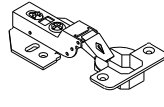

(5) 4PCS



Ø3*14mm

(6) 8PCS



(14) 2PCS

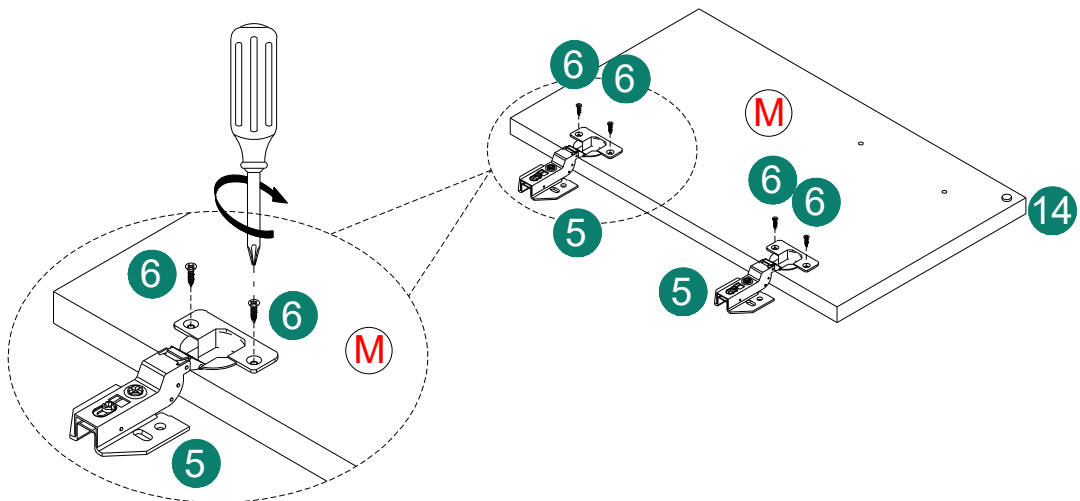
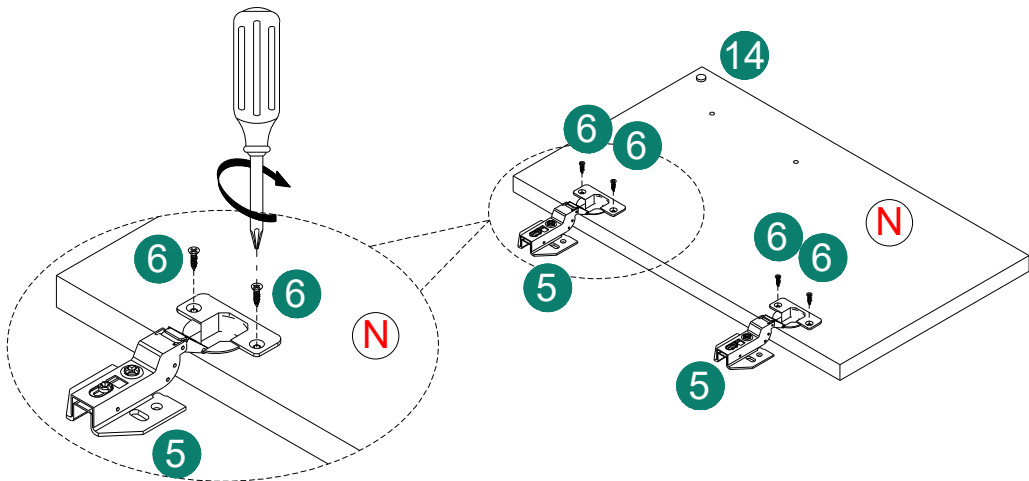

ASSEMBLY INSTRUCTIONS

8



10 4PCS

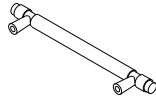

8 2PCS



Ø5*3/4"

9 4PCS



Ø3*14mm

6 16PCS

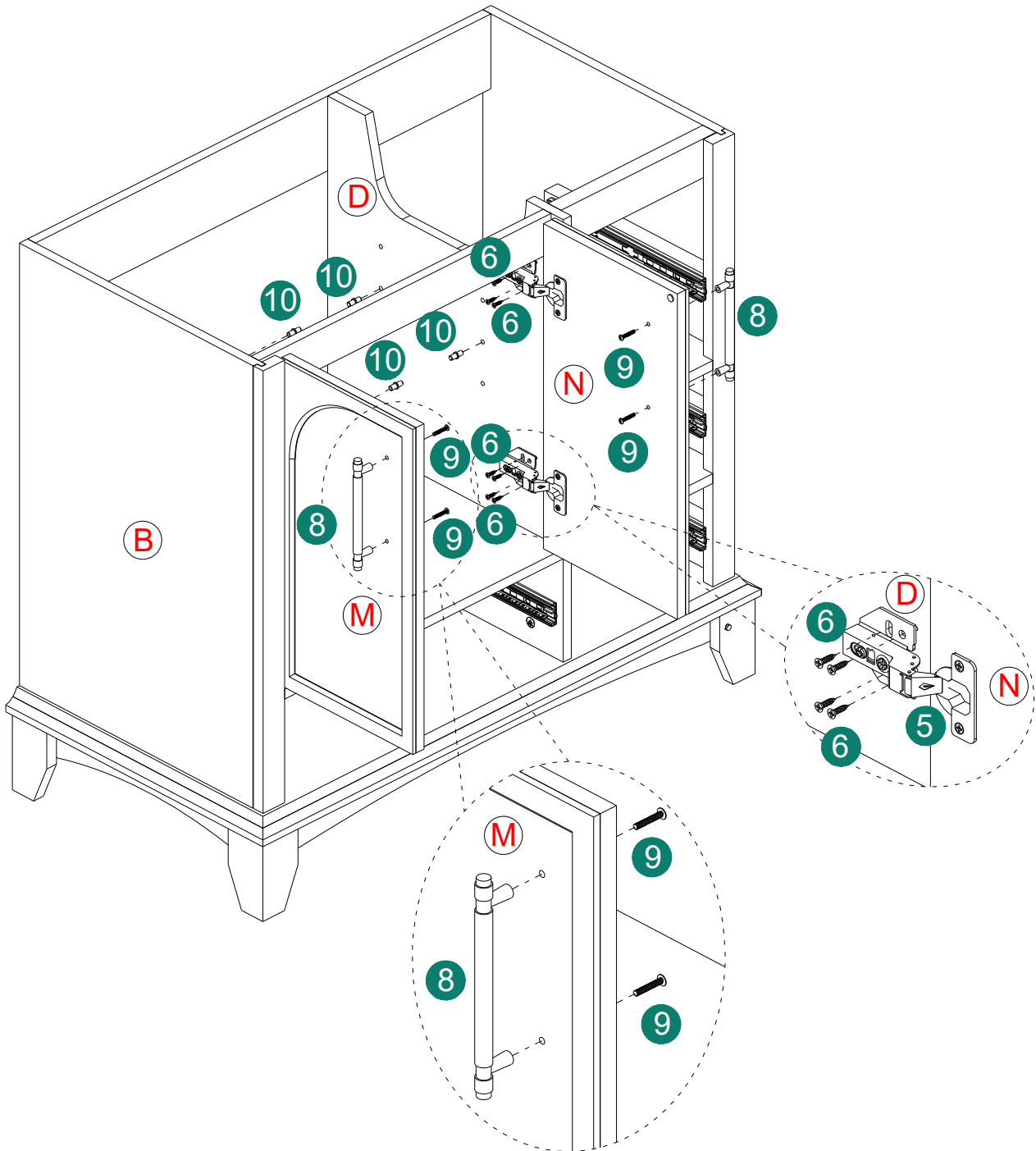

ASSEMBLY INSTRUCTIONS

10

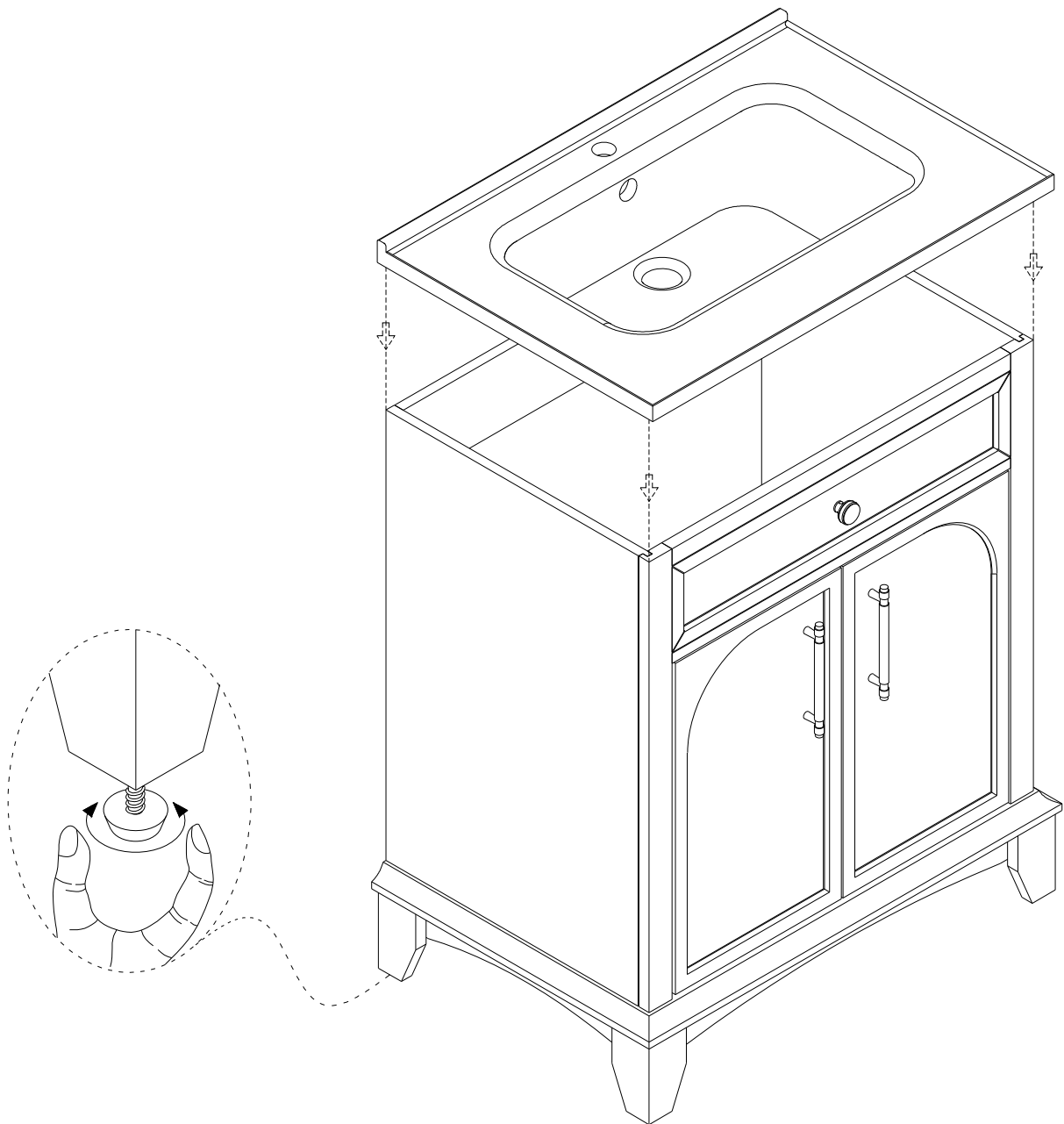

ASSEMBLY INSTRUCTIONS

10

Common Door Panel Issues:

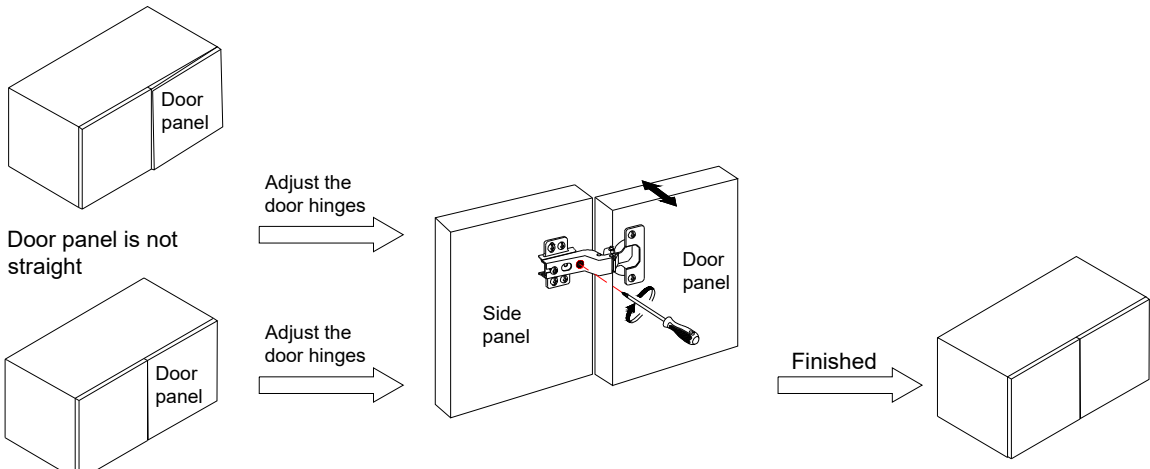

The gap between door panels is too large

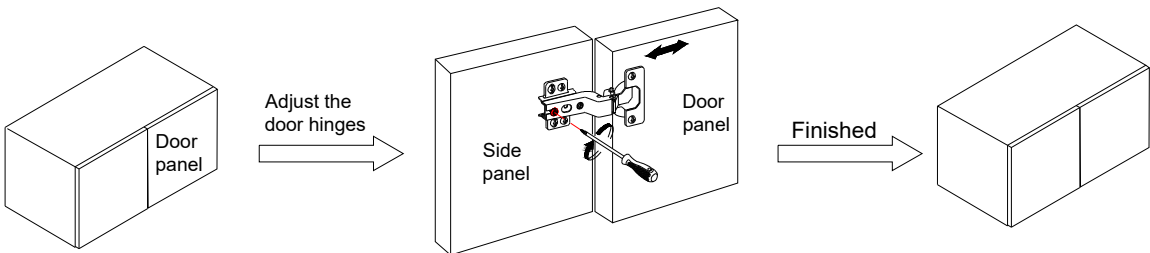

The door panels are not coplanar

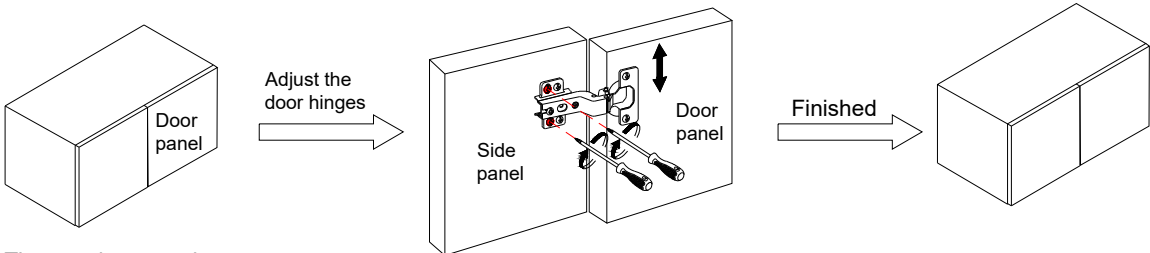

The two door panels are not at the same height

ASSEMBLY INSTRUCTIONS

12

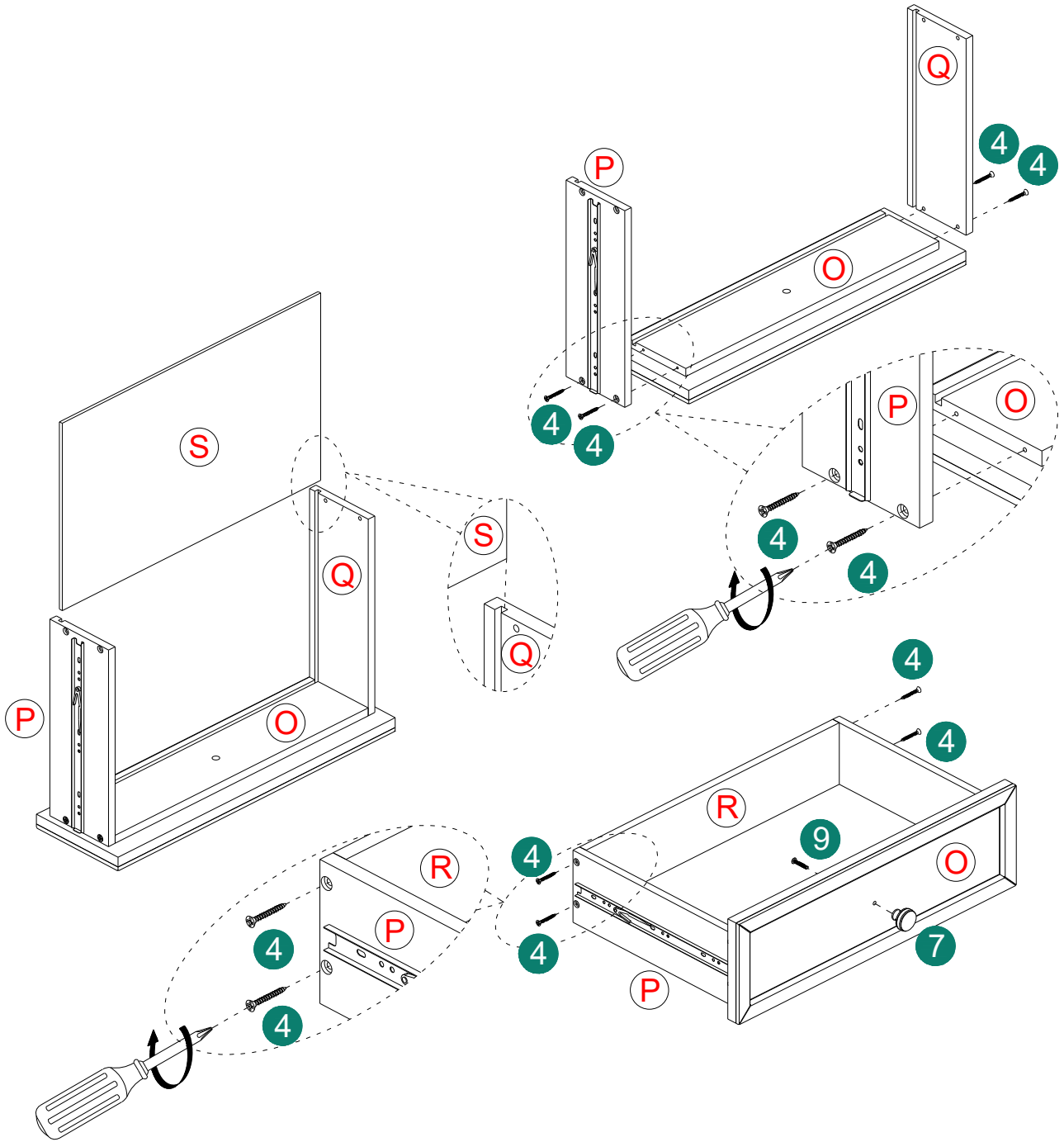
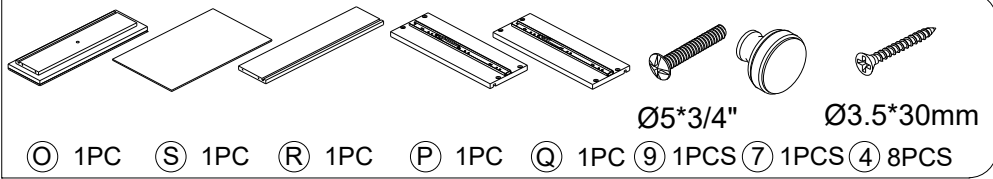

ASSEMBLY INSTRUCTIONS

13

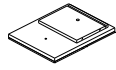

Ⓣ 1PC

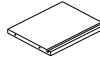

Ⓦ 1PC

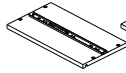

Ⓤ 1PC

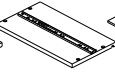

Ⓥ 1PC

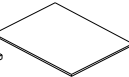

Ⓧ 1PC

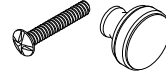

Ø5*3/4"

⑨ 2PCS



Ø3.5*30mm

⑦ 2PCS

④ 8PCS

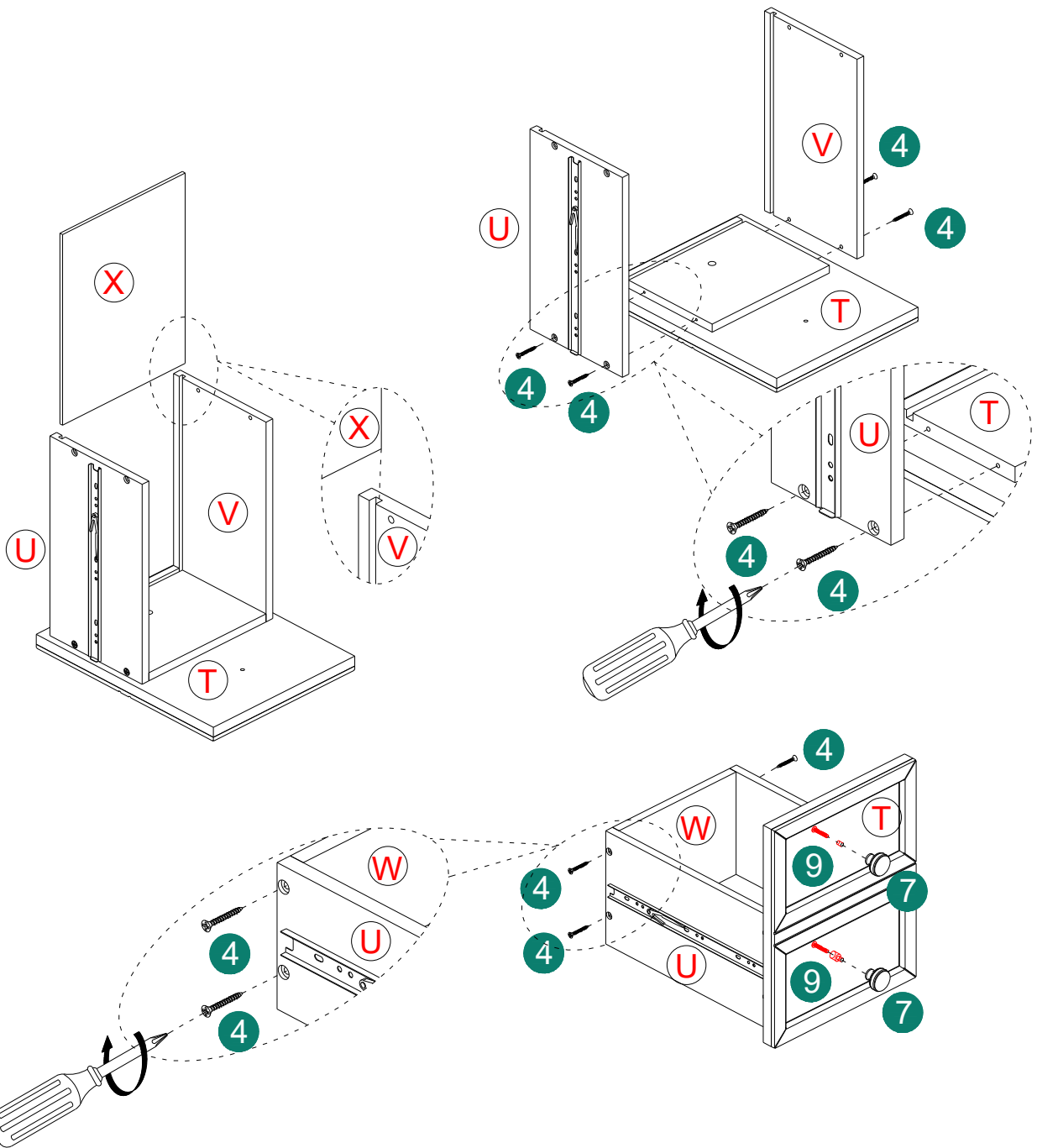

ASSEMBLY INSTRUCTIONS

14

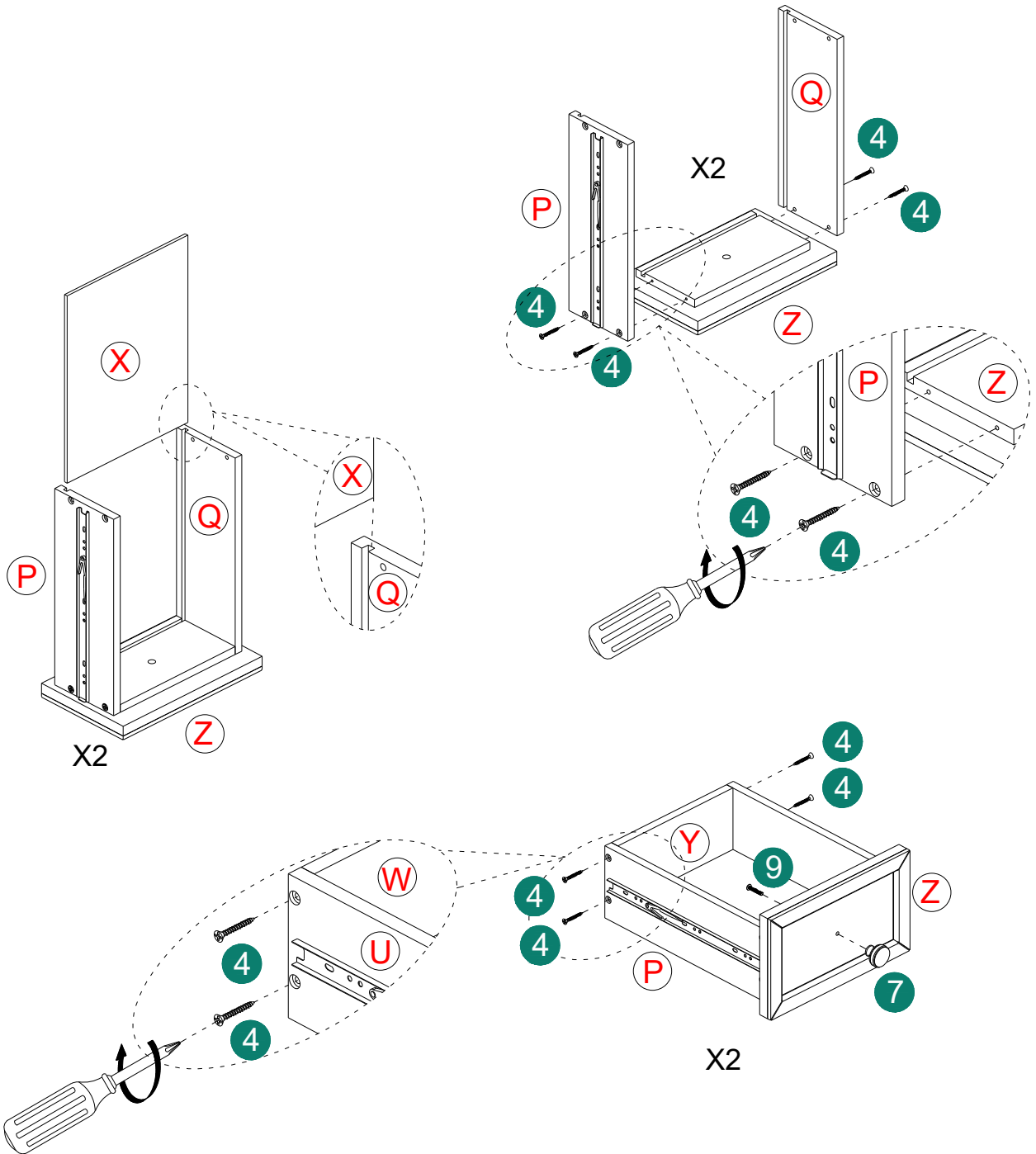
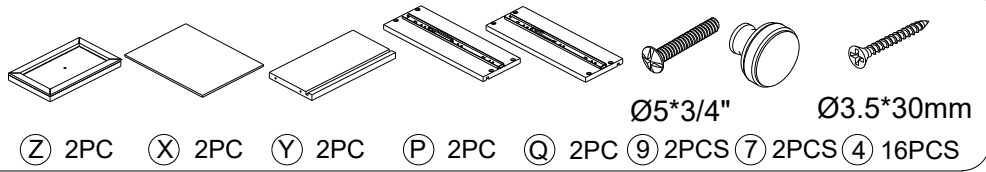

ASSEMBLY INSTRUCTIONS

15

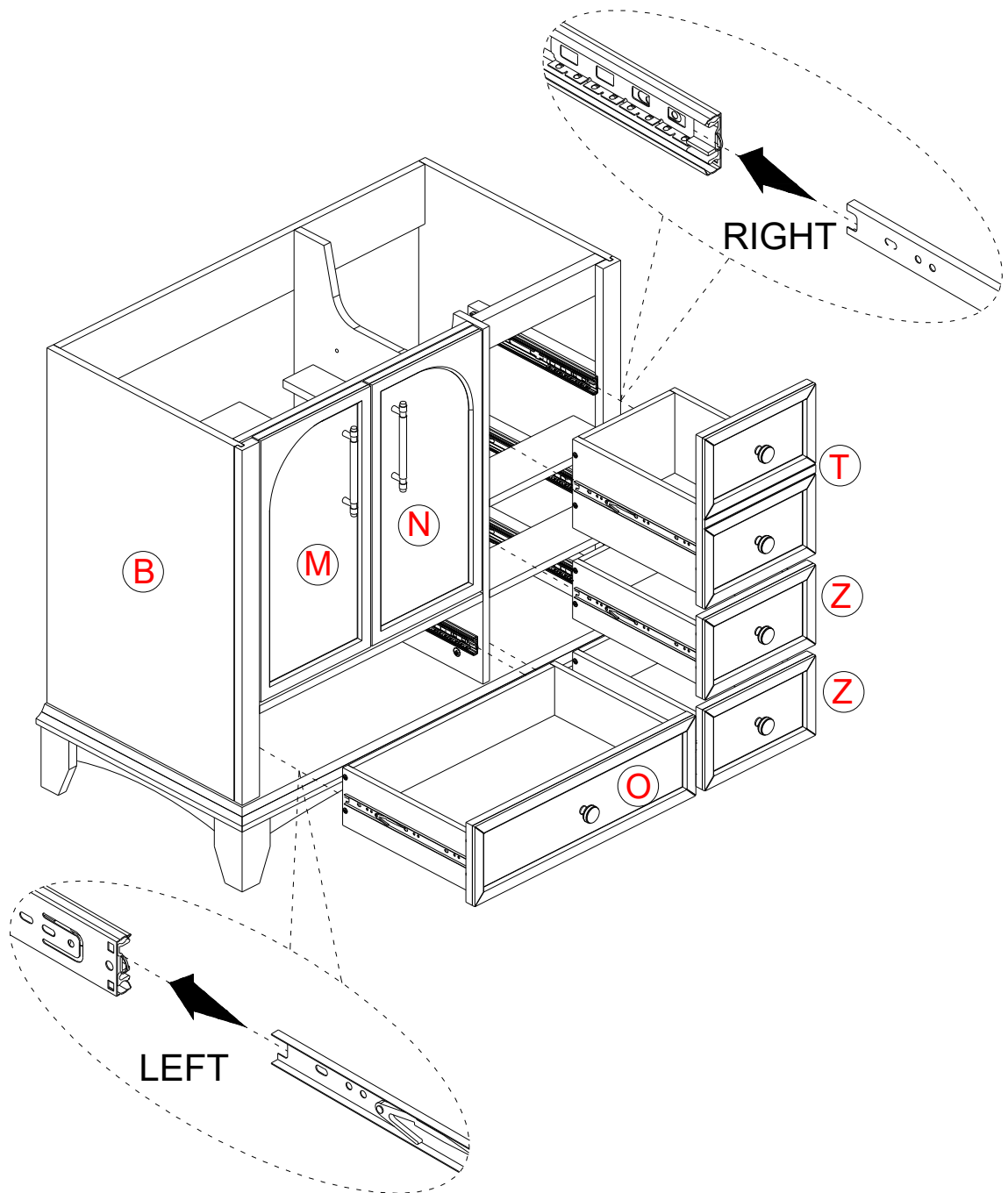

20

ASSEMBLY INSTRUCTIONS

16

