

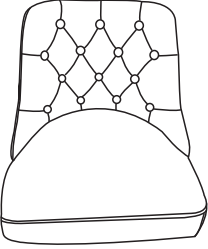

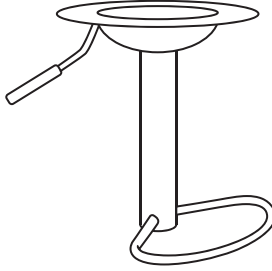

INSTRUCTION MANUAL

Bar Chair

PARTS DESCRIPTION

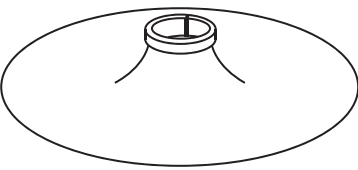
A	B	C	D	E
				<p data-bbox="1356 369 1484 414">M6*16</p>  <p data-bbox="1412 481 1460 526">x4</p>

ASSEMBLE STEPS

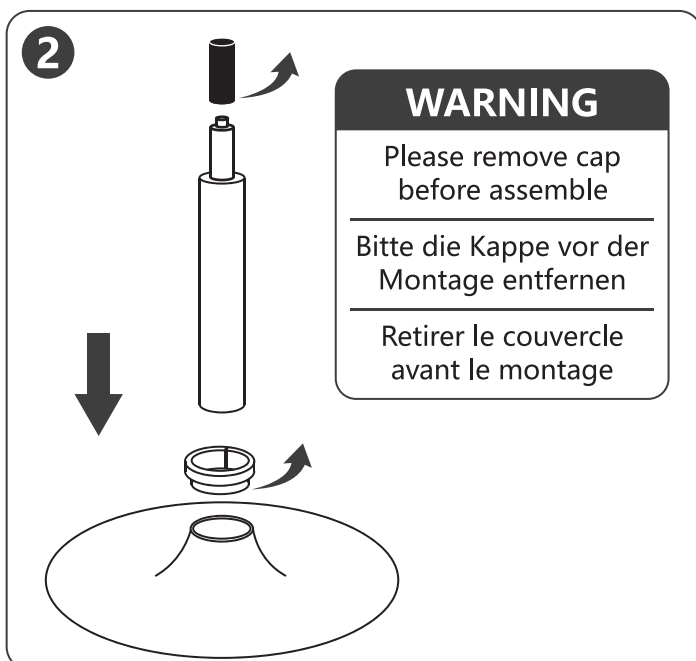
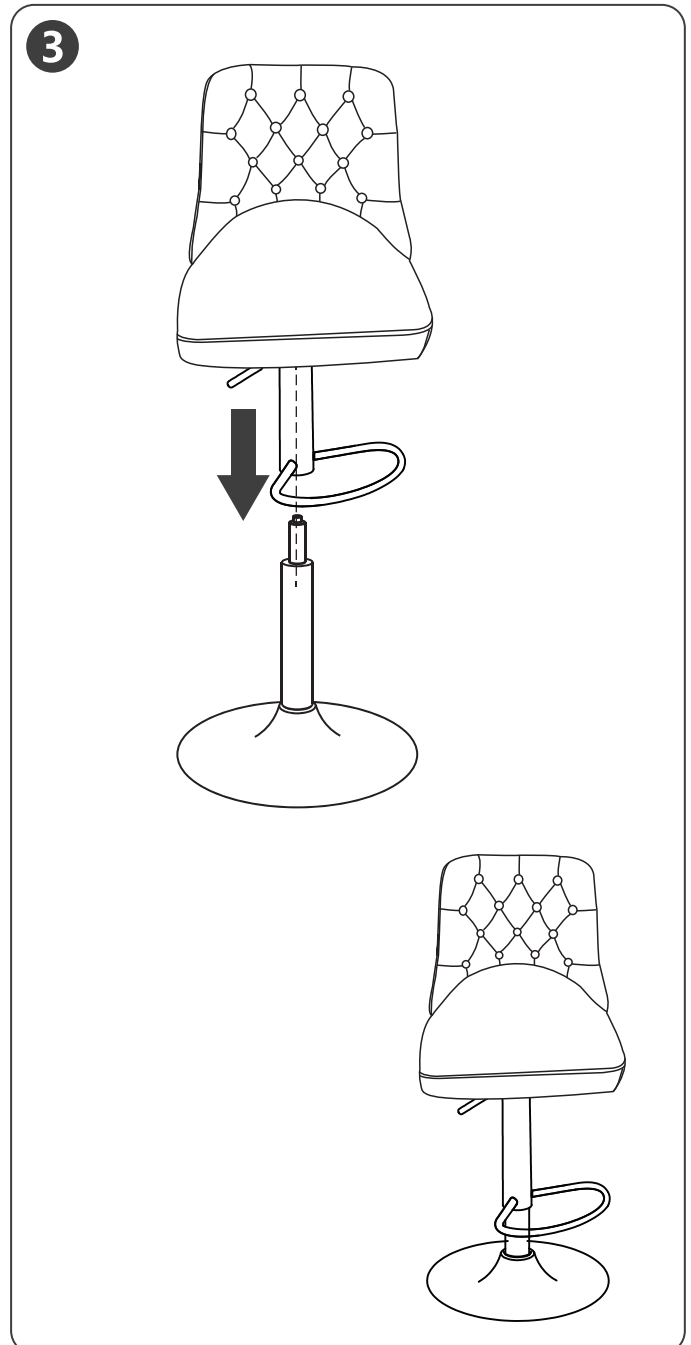
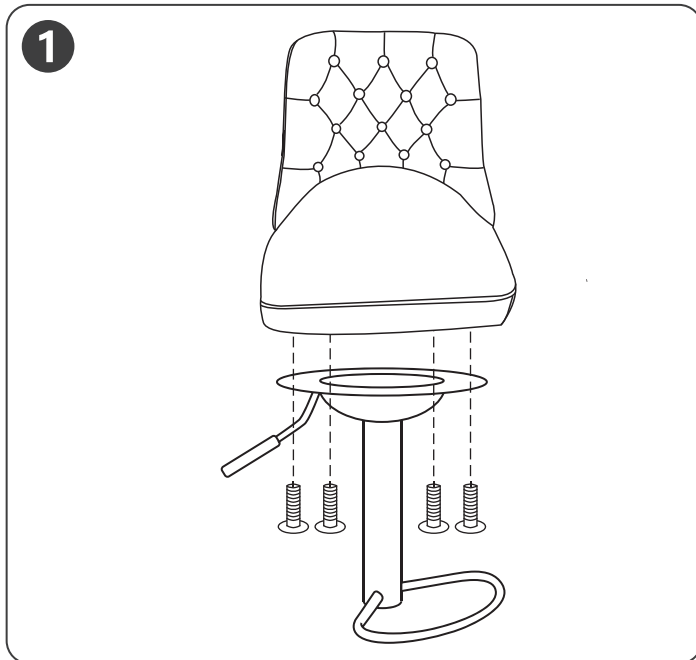

Please note: We provide fast after-sales service, don't worry if there is something wrong with the package you received. Please contact us first, we will reply you in time!