

# ASSEMBLY INSTRUCTION

SKU CODE:(N709P228532/N709P228533)

FULL LOFT BED

# INSTRUCTIONS DE MONTAGE

SKU NUMBER: (N709P228532/N709P228533)

LIT MEZZANINE COMPLET

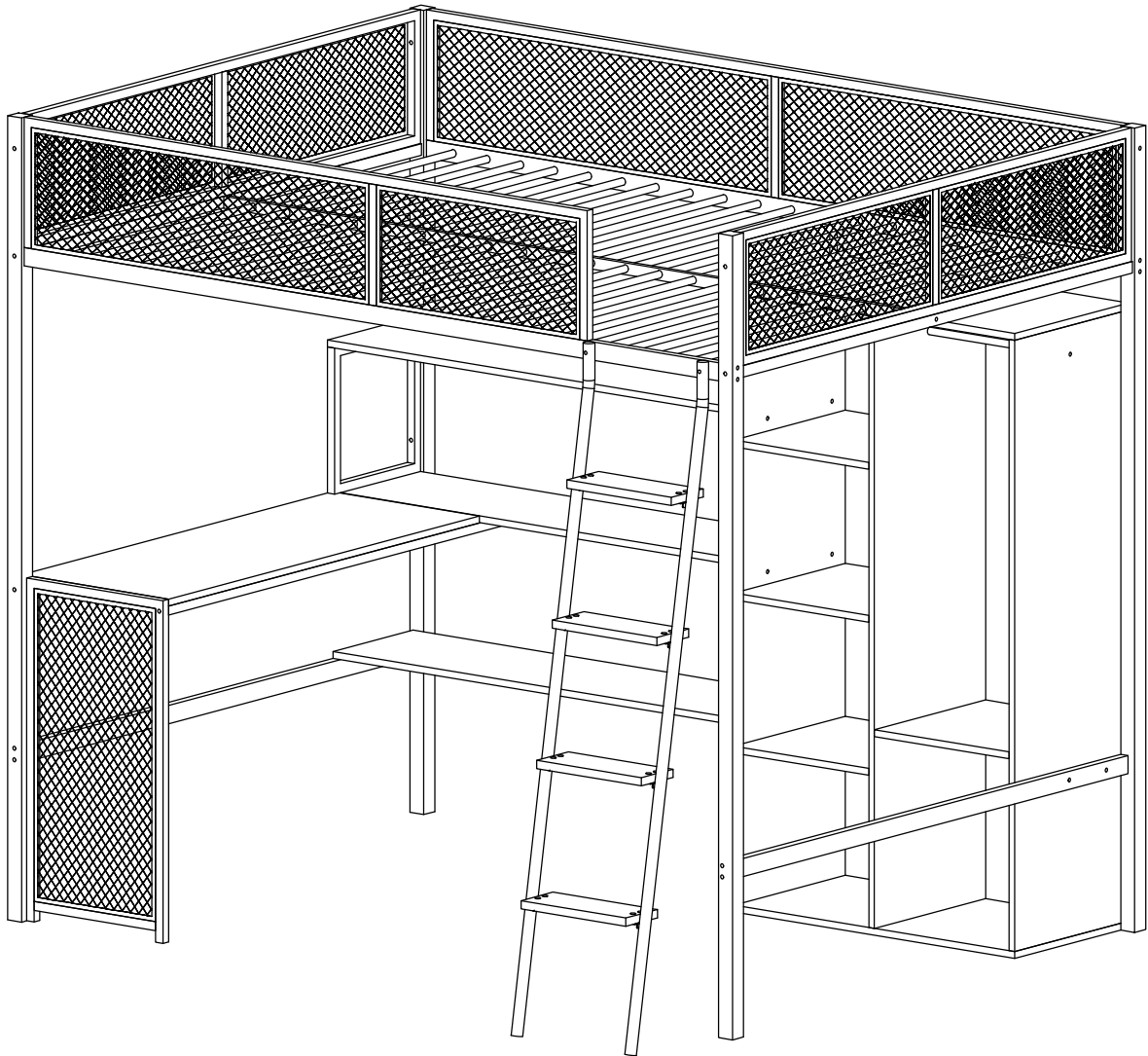

## **SAFETY WARNINGS AND GENERAL NOTES :**

1. Follow the information on the warnings appearing on the upper bunk bed end structure and on the carton. Do not remove the warning label from the bed.
2. Always use the recommended size mattress or mattress support, or both, to help prevent the likelihood of entrapment or falls.
3. Do not allow children under 6 years of age to use the upper bunk.
4. Periodically check and ensure the guardrail, ladder and other components are in their proper position, free from damage, and all connectors are tight.
5. Do not allow horseplay on or under beds.
6. Always prohibit jumping on the bed.
7. Prohibit more than one person on upper bunk.
8. Always use the ladder for entering and leaving the upper bunk.
9. Do not use substitute parts. Contact the manufacturer or dealer for replacement parts.
10. Use of a night light may provide added safety precaution for a child using the upper bunk.
11. Always use guardrails on both long sides of the upper bunk.
12. If the bunk bed will be placed next to a wall, the guardrail that runs the full length of the bed should be placed against the wall to prevent entrapment between the bed and the wall. The use of water or sleep flotation mattresses is prohibited.
13. **STRANGULATION HAZARD**-Never attach or hang items to any part of the bunk bed that are not designed for use with the bed. for example, but not limited to, hooks, belts and jump ropes.
14. Keep these instructions for future reference.
15. We recommend assembling your bunk bed on the shipping carton to protect your floor or carpet.
16. Be certain all staples are out of the box before beginning assembly on the shipping carton.
17. **USE ONLY MATTRESSES WHICH ARE AS THE TABLE BELOW ON UPPER BUNKS.**

Upper bed (bunk bed and tribed included)

Bed type	Length	Width	Thickness
Full Standard	74" - 75"	53 1/2"	6" max

18. **SURFACE OF MATTRESS MUST BE AT LEAST 5" (127MM) BELOW THE UPPER EDGE OF GUARDRAILS.**

19. **Replacement Parts:**

Replacement Parts, including additional guardrails, may be obtained from any of our (GIGACLOUD TECHNOLOGY (USA) INC. ) dealers.

## **AVERTISSEMENTS DE SÉCURITÉ ET REMARQUES GÉNÉRALES :**

1. Suivez les informations figurant sur les avertissements figurant sur la structure d'extrémité du lit superposé supérieur et sur le carton. Ne retirez pas l'étiquette d'avertissement du lit.
2. Utilisez toujours le matelas ou le support de matelas de taille recommandée, ou les deux, pour éviter tout risque de coincement ou de chute.
3. Ne laissez pas les enfants de moins de 6 ans utiliser le lit supérieur.
4. Vérifiez périodiquement et assurez-vous que le garde-corps, l'échelle et les autres composants sont dans leur bonne position, exempts de dommages et que tous les connecteurs sont bien serrés.
5. Ne laissez pas les chahuts sur ou sous les lits.
6. Interdisez toujours de sauter sur le lit.
7. Interdire plus d'une personne sur la couchette supérieure.
8. Utilisez toujours l'échelle pour entrer et sortir du lit supérieur.
9. N'utilisez pas de pièces de rechange. Contactez le fabricant ou le revendeur pour obtenir des pièces de rechange.
10. L'utilisation d'une veilleuse peut fournir une mesure de sécurité supplémentaire pour un enfant utilisant le lit supérieur.
11. Utilisez toujours des garde-corps sur les deux côtés longs du lit supérieur.
12. Si le lit superposé doit être placé à côté d'un mur, le garde-corps qui s'étend sur toute la longueur du lit doit être placé contre le mur pour éviter tout coincement entre le lit et le mur. L'utilisation de matelas flottants à eau ou de sommeil est interdite.
13. **RISQUE D'ÉTRANGULATION** - N'attachez ou ne suspendez jamais d'objets à une partie du lit superposé qui ne sont pas conçu pour être utilisé avec le lit, par exemple, mais sans s'y limiter, des crochets, des ceintures et des cordes à sauter.
14. Conservez ces instructions pour référence future.
15. Nous vous recommandons d'assembler votre lit superposé sur le carton d'expédition pour protéger votre sol ou votre tapis.
16. Assurez-vous que toutes les agrafes sont sorties de la boîte avant de commencer l'assemblage sur le carton d'expédition.
17. **UTILISER UNIQUEMENT DES MATELAS QUI SONT COMME DANS LE TABLEAU CI-DESSOUS SUR LES SUPERPOSÉS.**

Lit supérieur (lits superposés et triblés inclus)

Type de lit	Longueur	Largeur	Épaisseur
Norme complète	74" - 75"	53 1/2"	6" max



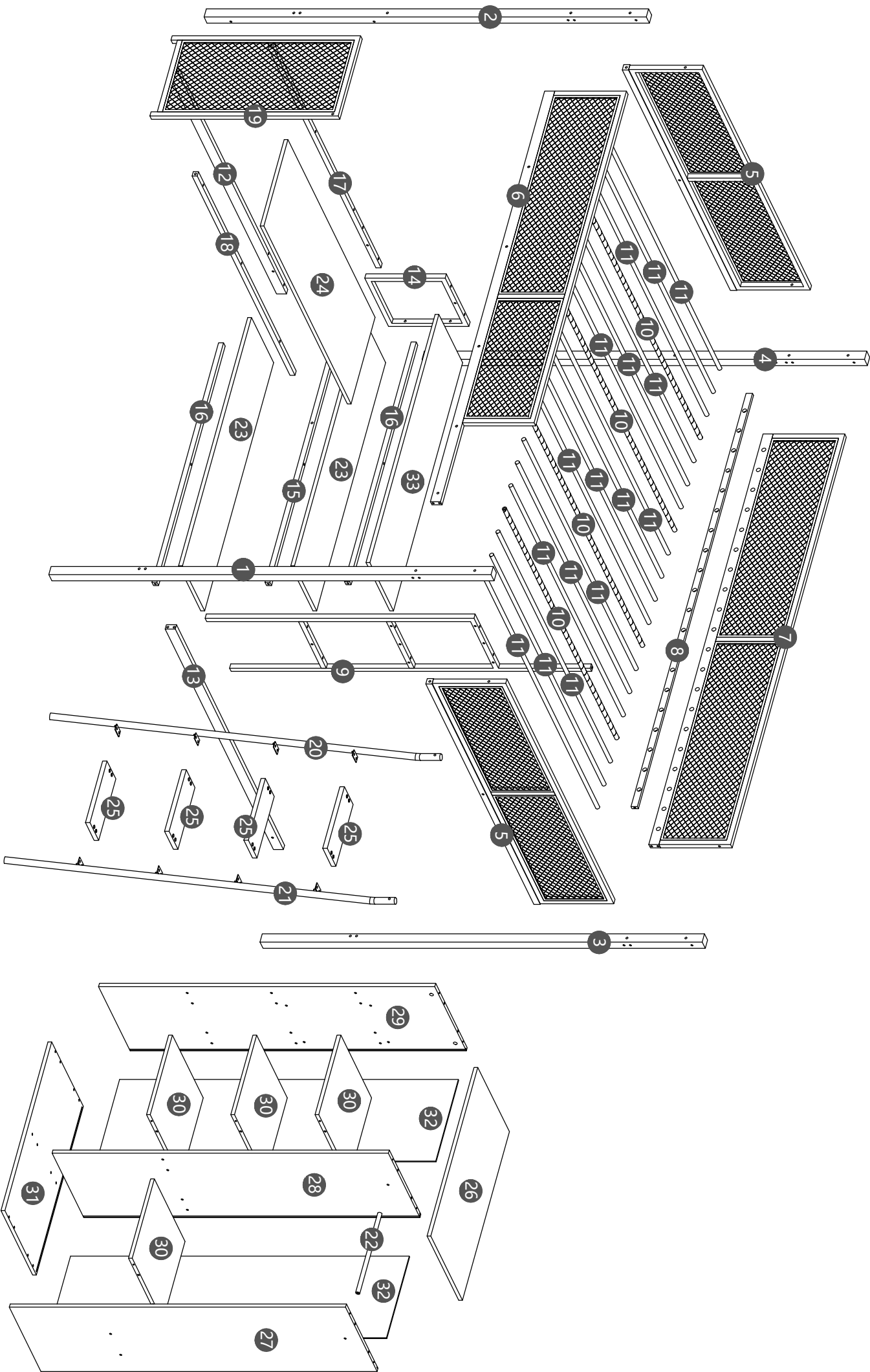

18. **LA SURFACE DU MATELAS DOIT ÊTRE AU MOINS 5" (127 MM) EN DESSOUS DU BORD SUPÉRIEUR DES GARDE-CORPS.**

19. Pièces de rechange :



Les pièces de rechange, y compris les garde-corps supplémentaires, peuvent être obtenues auprès de l'un de nos revendeurs (GIGACLOUD TECHNOLOGY (USA) INC. )



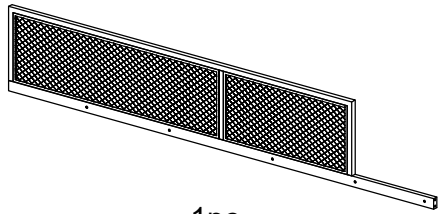
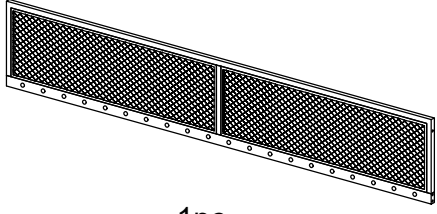
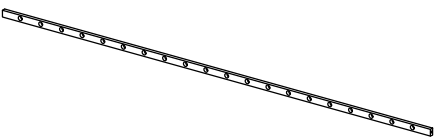
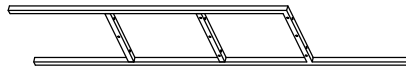
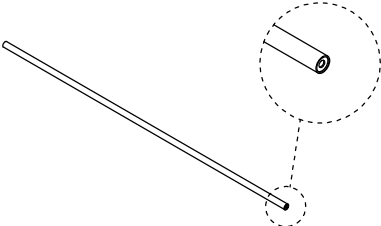
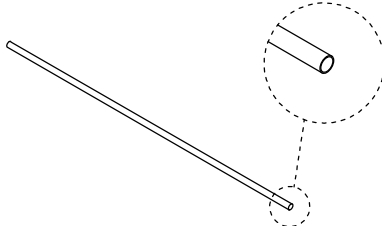
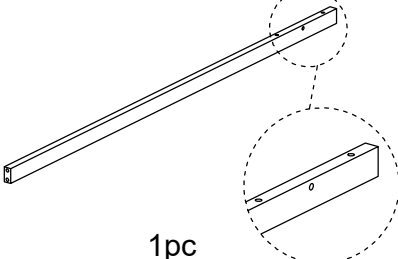
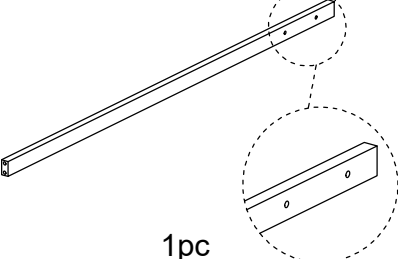
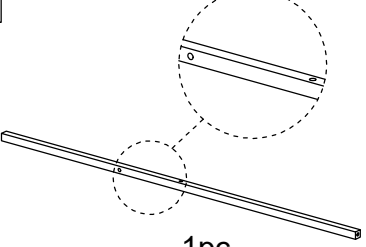
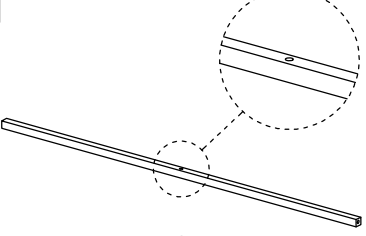
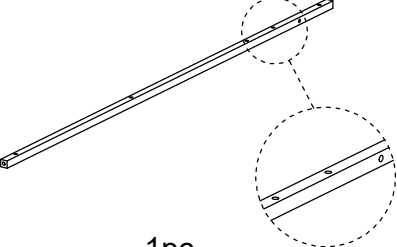
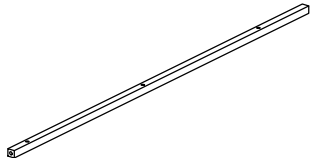
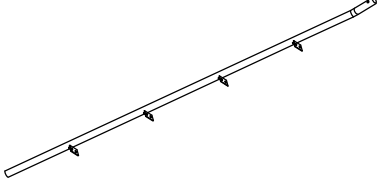
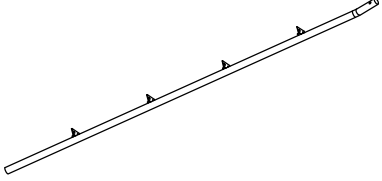
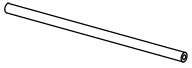



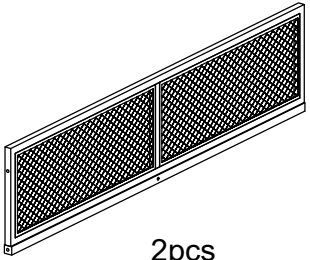
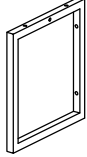
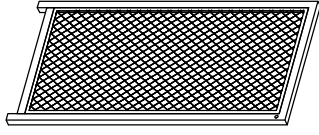
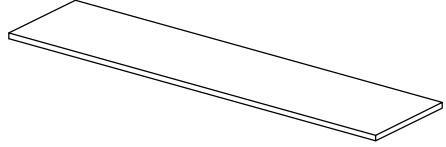
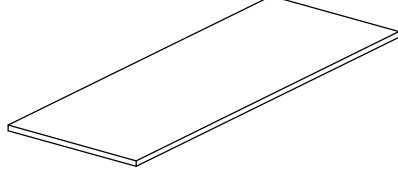
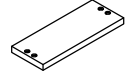
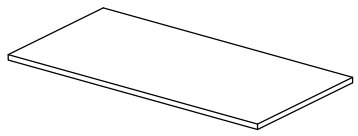
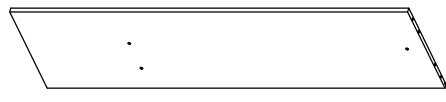
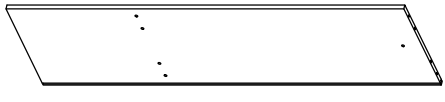

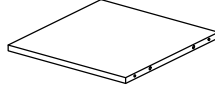
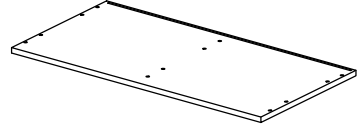
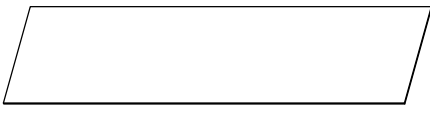
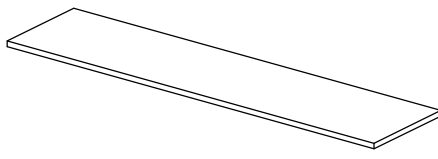

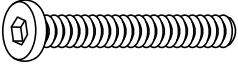
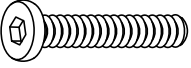
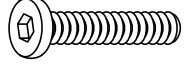
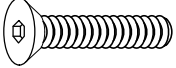
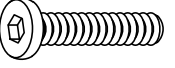
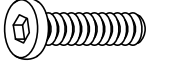
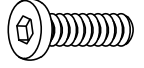

# Parts List/Liste des pièces N709P228532

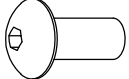
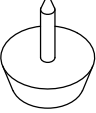
<p>1</p>  <p>1pc</p>	<p>2</p>  <p>1pc</p>	<p>3</p>  <p>1pc</p>
<p>4</p>  <p>1pc</p>	<p>6</p>  <p>1pc</p>	<p>7</p>  <p>1pc</p>
<p>8</p>  <p>1pc</p>	<p>9</p>  <p>1pc</p>	<p>10</p>  <p>4pcs</p>
<p>11</p>  <p>16pcs</p>	<p>12</p>  <p>1pc</p>	<p>13</p>  <p>1pc</p>
<p>15</p>  <p>1pc</p>	<p>16</p>  <p>2pcs</p>	<p>17</p>  <p>1pc</p>
<p>18</p>  <p>1pc</p>	<p>20</p>  <p>1pc</p>	<p>21</p>  <p>1pc</p>
<p>22</p>  <p>1pc</p>		

# Parts List/Liste des pièces N709P228533

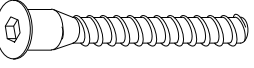
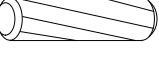
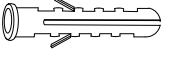
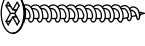

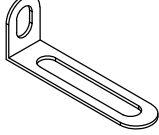
<p>5</p>  <p>2pcs</p>	<p>14</p>  <p>1pc</p>	<p>19</p>  <p>1pc</p>
<p>23</p>  <p>2pcs</p>	<p>24</p>  <p>1pc</p>	<p>25</p>  <p>4pcs</p>
<p>26</p>  <p>1pc</p>	<p>27</p>  <p>1pc</p>	<p>28</p>  <p>1pc</p>
<p>29</p>  <p>1pc</p>	<p>30</p>  <p>4pcs</p>	<p>31</p>  <p>1pc</p>
<p>32</p>  <p>2pcs</p>	<p>33</p>  <p>1pc</p>	

# Hardware List /Liste du matériel N709P228532

<p><b>A</b></p>  <p>M6*60mm 23pcs</p>	<p><b>B</b></p>  <p>M6*50mm 2pcs</p>	<p><b>C</b></p>  <p>M6*45mm 18pcs</p>
<p><b>D</b></p>  <p>M6*45mm 3pcs</p>	<p><b>E</b></p>  <p>M6*30mm 19pcs</p>	<p><b>F</b></p>  <p>M6*28mm 8pcs</p>
<p><b>G</b></p>  <p>M6*25mm 16pcs</p>	<p><b>H</b></p>  <p>M6*16mm 7pcs</p>	<p><b>I</b></p>  <p>M6 17pcs</p>
<p><b>J</b></p>  <p>17pcs</p>	<p><b>K</b></p>  <p>6pcs</p>	<p><b>L</b></p>  <p>2pcs</p>
<p><b>M</b></p>  <p>1pc</p>	<p><b>N</b></p>  <p>Ø6*35mm 22pcs</p>	<p><b>O</b></p>  <p>22pcs</p>
<p><b>P</b></p>  <p>Ø7*40mm 6pcs</p>	<p><b>Q</b></p>  <p>Ø8*30mm 28pcs</p>	<p><b>R</b></p>  <p>2pcs</p>
<p><b>S</b></p>  <p>Ø4*35mm 2pcs</p>	<p><b>T</b></p>  <p>Ø4*14mm 2pcs</p>	<p><b>U</b></p>  <p>2pcs</p>
<p><b>U</b></p>  <p>M6*55mm 2pcs</p>		

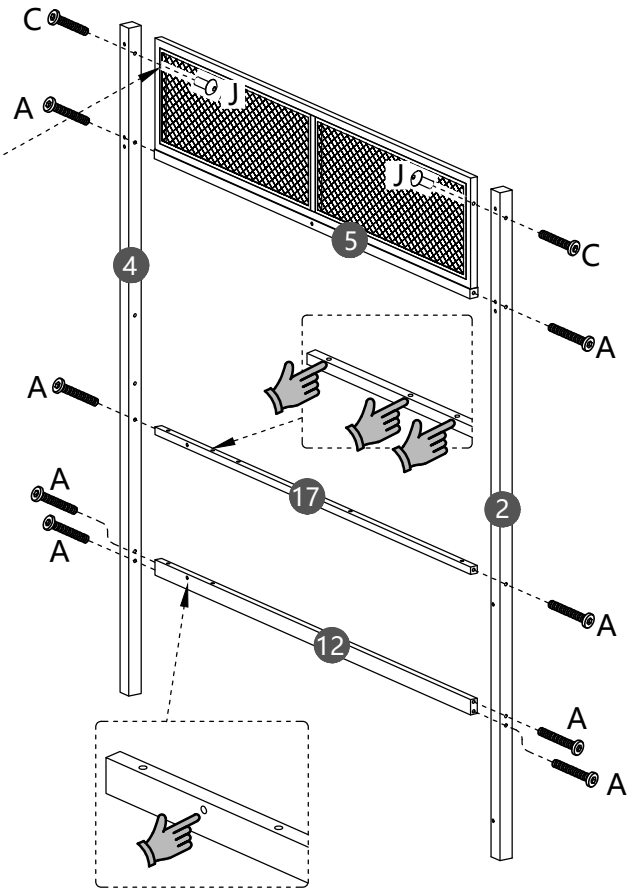
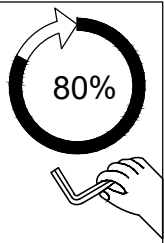
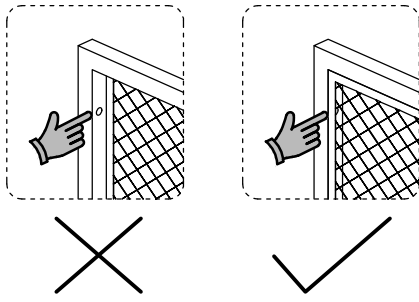

# STEP 1: Étape 1:

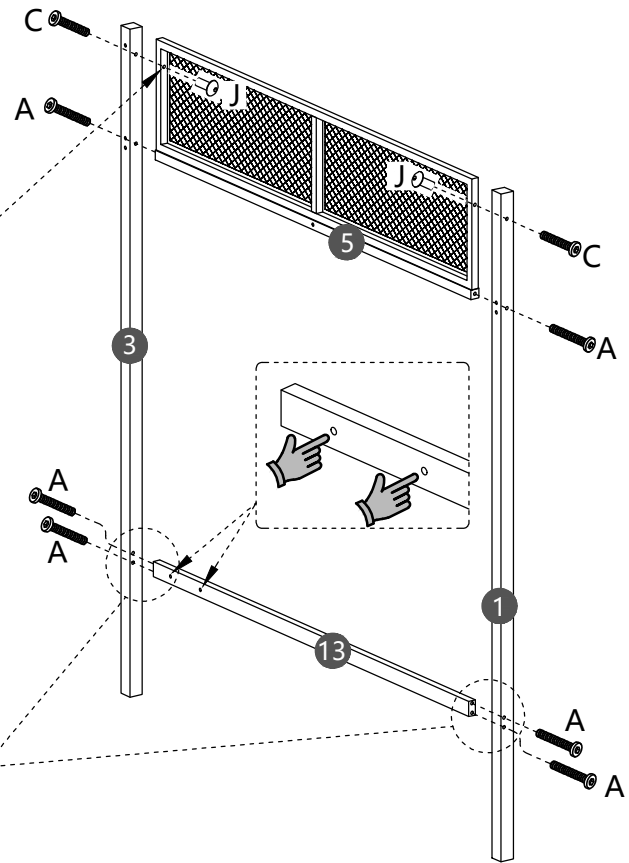
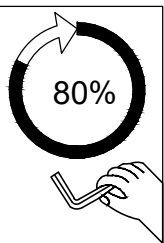
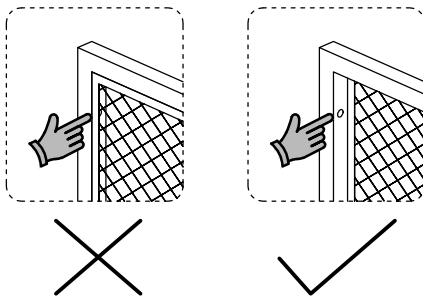

<b>A</b>

M6*60mm
8PCS
<b>C</b>

M6*45mm
2PCS
<b>J</b>

2PCS

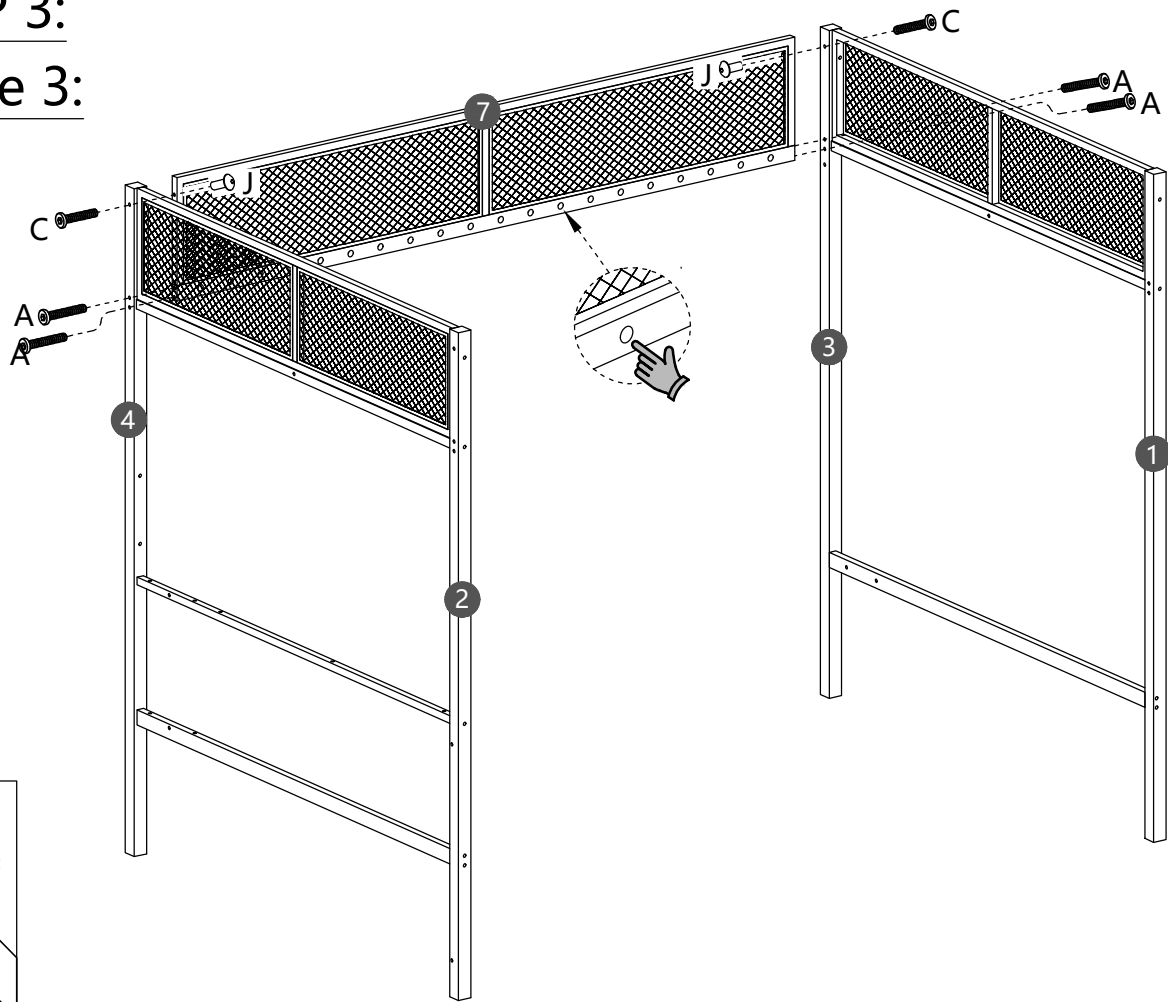

# STEP 2: Étape 2:



<b>A</b>

M6*60mm
6PCS
<b>C</b>

M6*45mm
2PCS
<b>J</b>

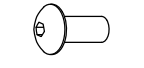
2PCS

**STEP 3:**  
**Étape 3:**



<b>A</b>

M6*60mm
4PCS
<b>C</b>

M6*45mm
2PCS
<b>J</b>

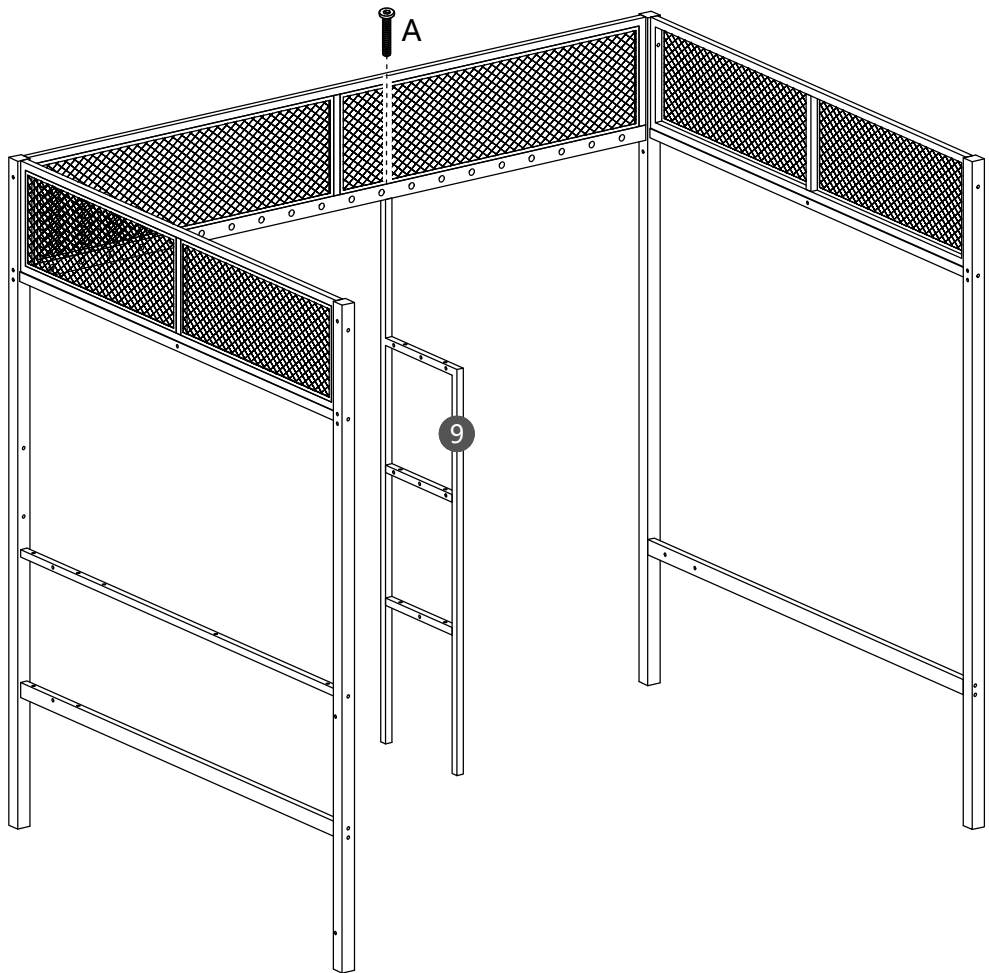
2PCS

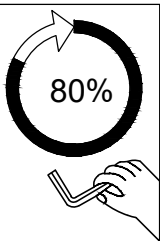

**STEP 4:**  
**Étape 4:**





<b>A</b>

M6*60mm
1PC

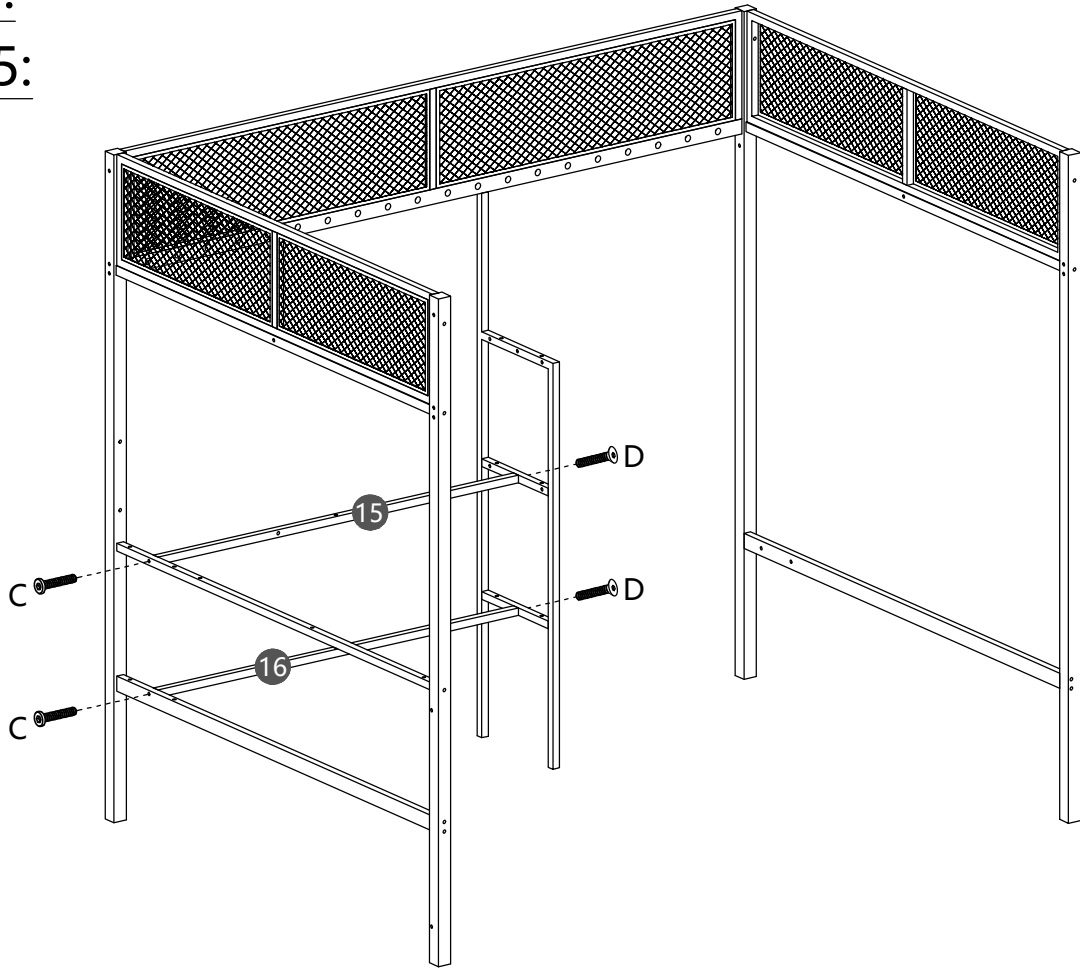

**STEP 5:**  
**Étape 5:**



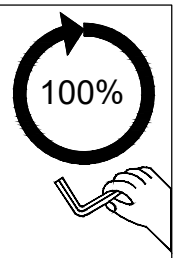

<b>C</b>

M6*45mm
2PCS
<b>D</b>

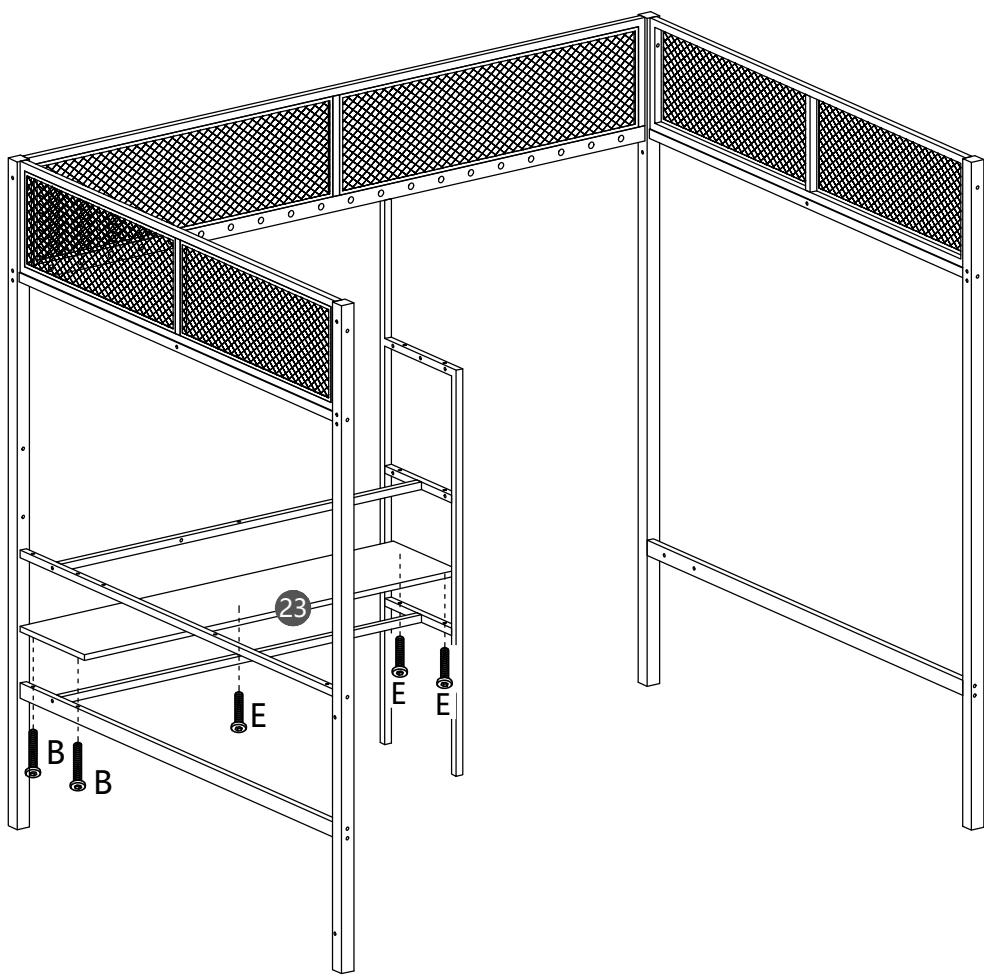
M6*45mm
2PCS



**STEP 6:**  
**Étape 6:**

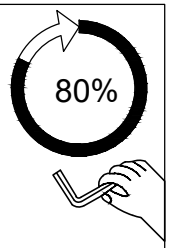



<b>B</b>

M6*50mm
2PCS
<b>E</b>

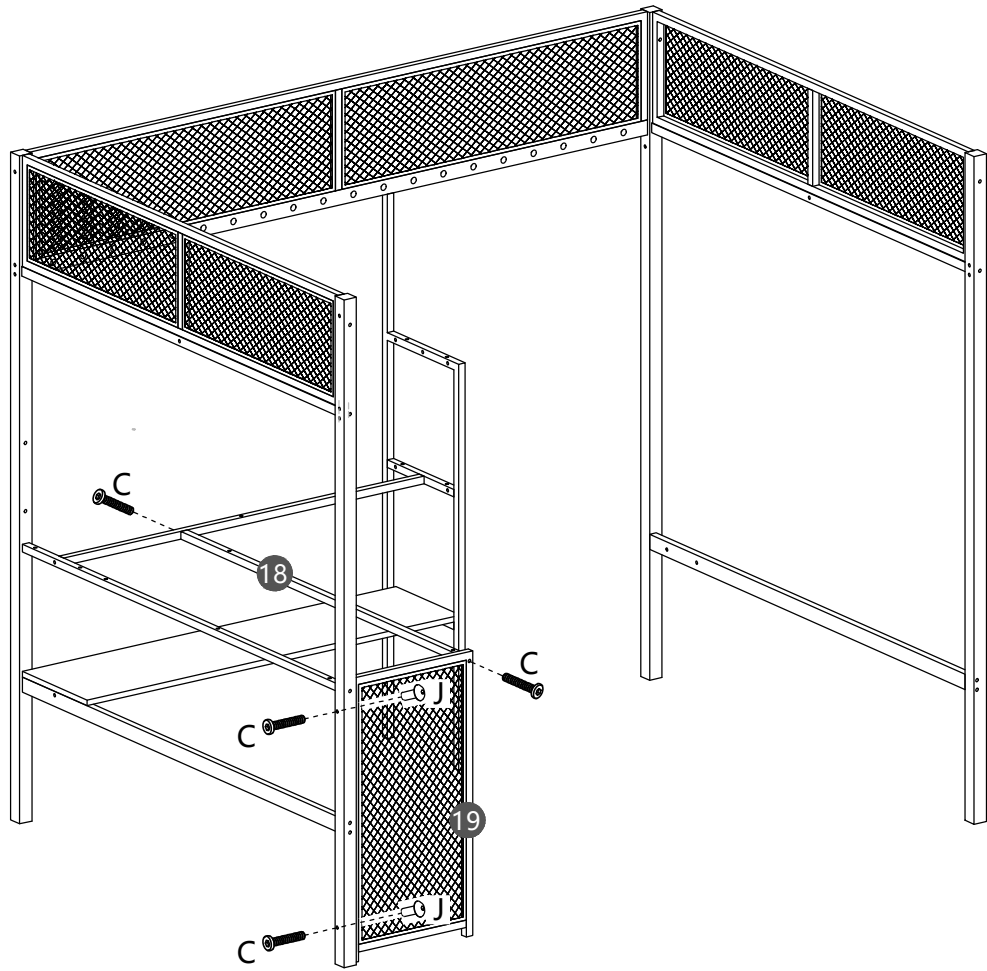
M6*30mm
3PCS



**STEP 7:**  
**Étape 7:**

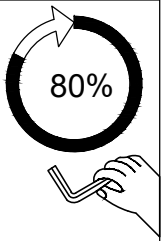

<b>C</b>

M6*45mm
4PCS
<b>J</b>

2PCS

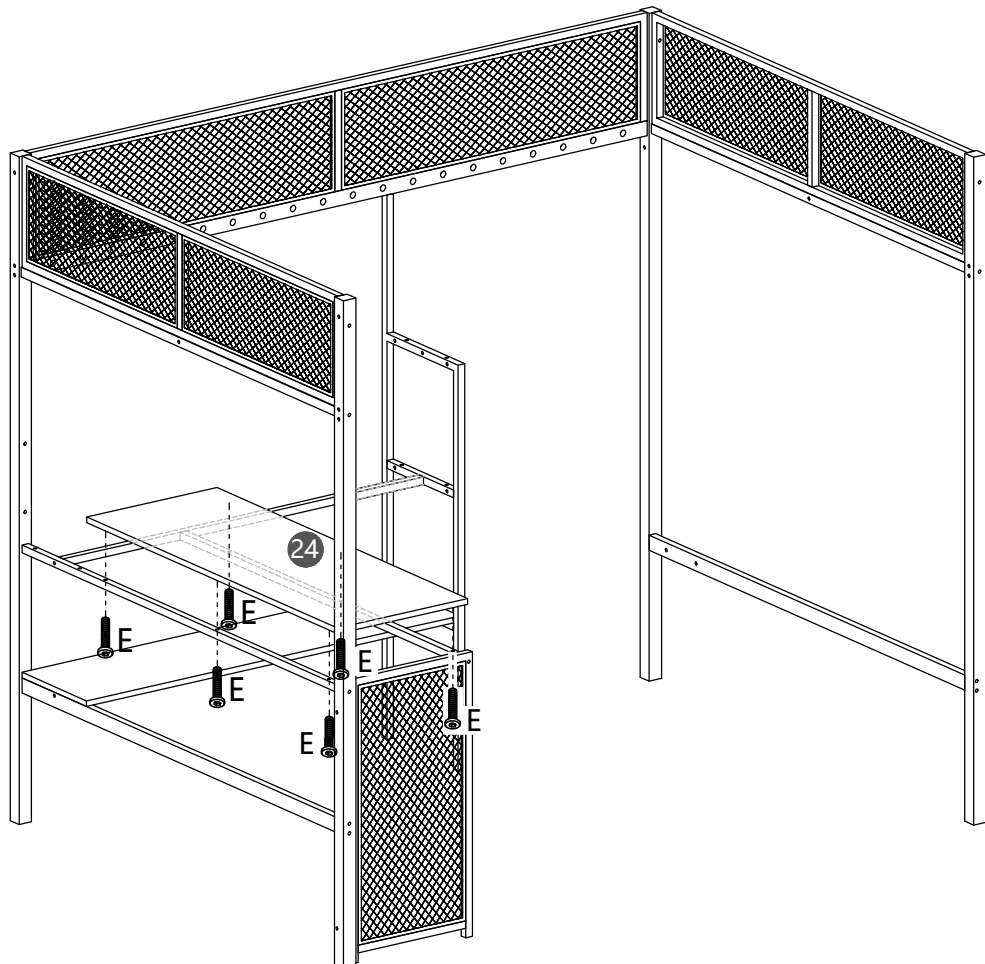

**STEP 8:**  
**Étape 8:**

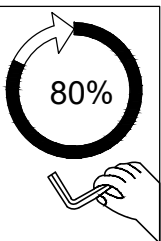

<b>E</b>

M6*30mm
6PCS

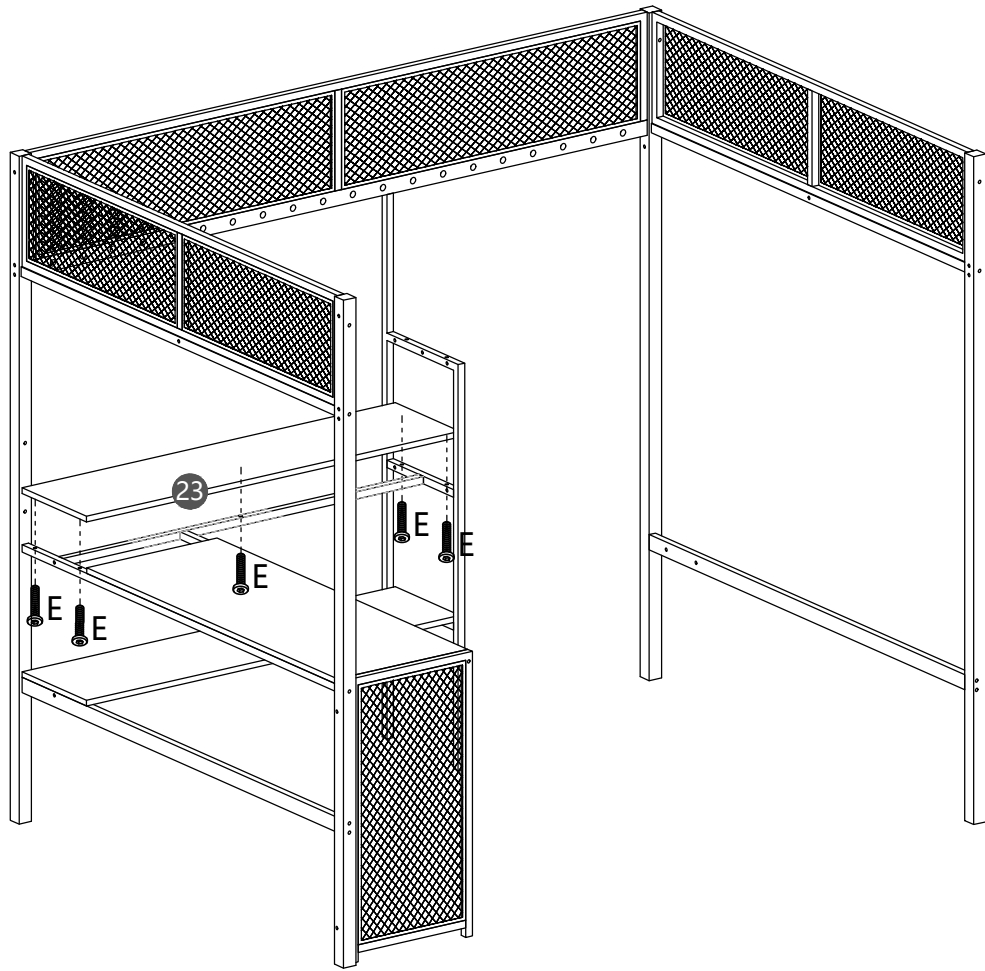

**STEP 9:**  
**Étape 9:**



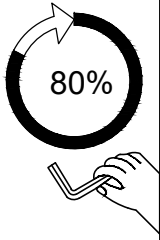

<b>E</b>

M6*30mm
5PCS

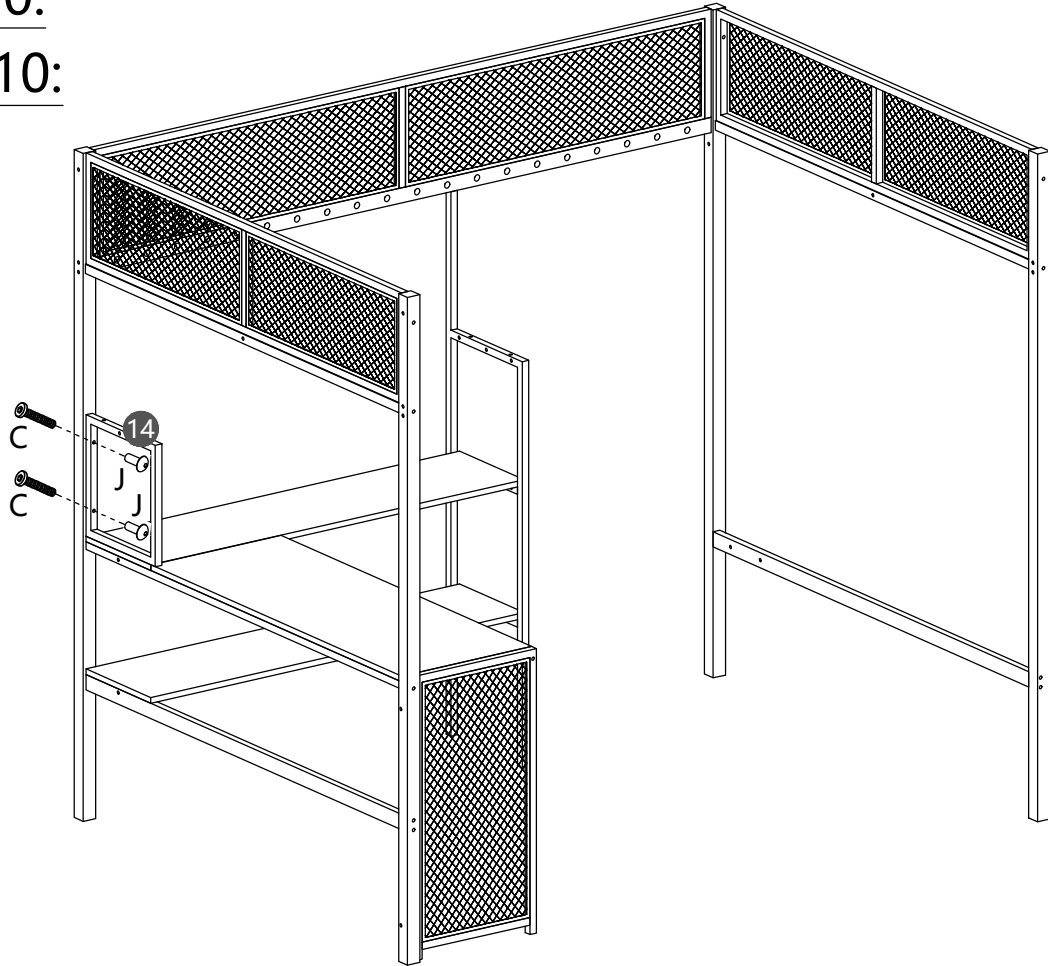

**STEP 10:**  
**Étape 10:**



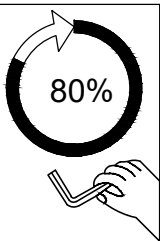

<b>C</b>

M6*45mm
2PCS
<b>J</b>

2PCS

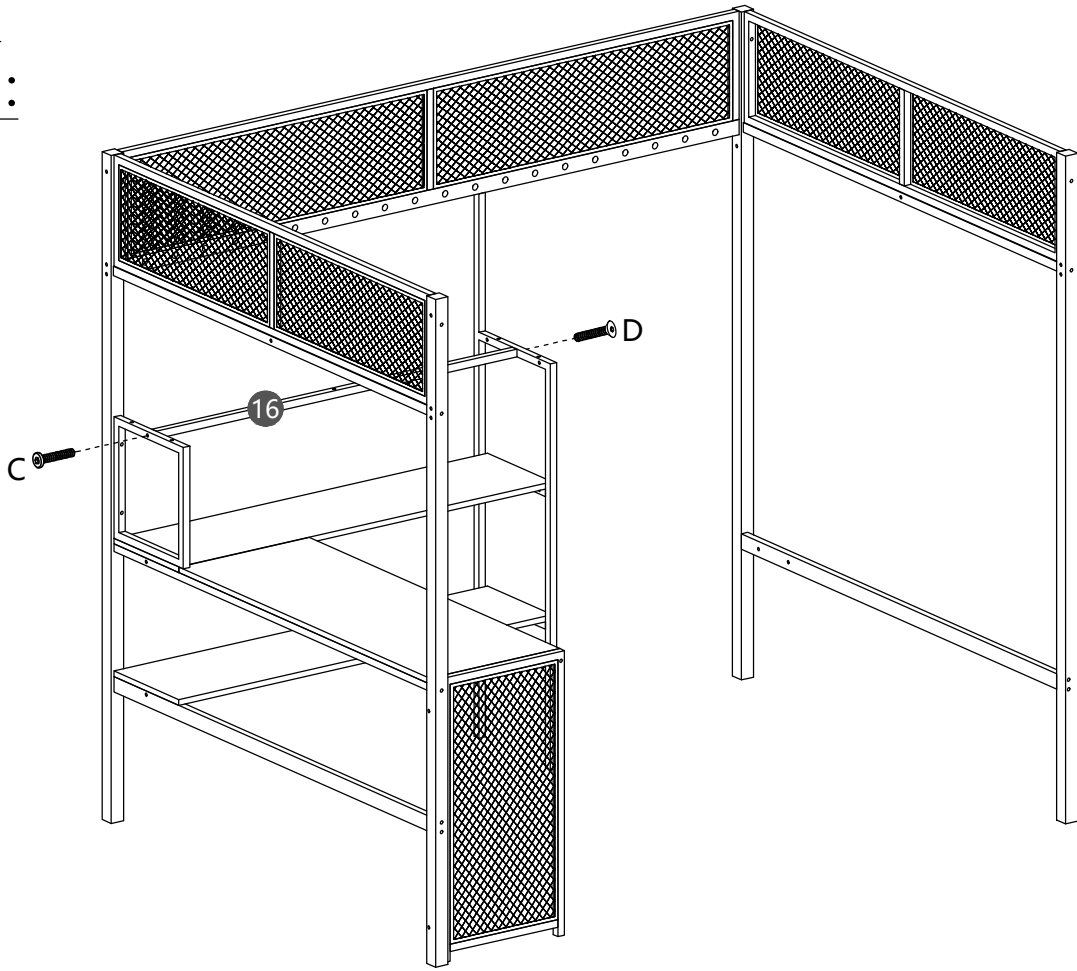

# STEP 11:

## Étape 11:



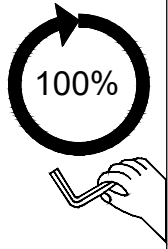

<b>C</b>

M6*45mm
1PC
<b>D</b>

M6*45mm
1PC

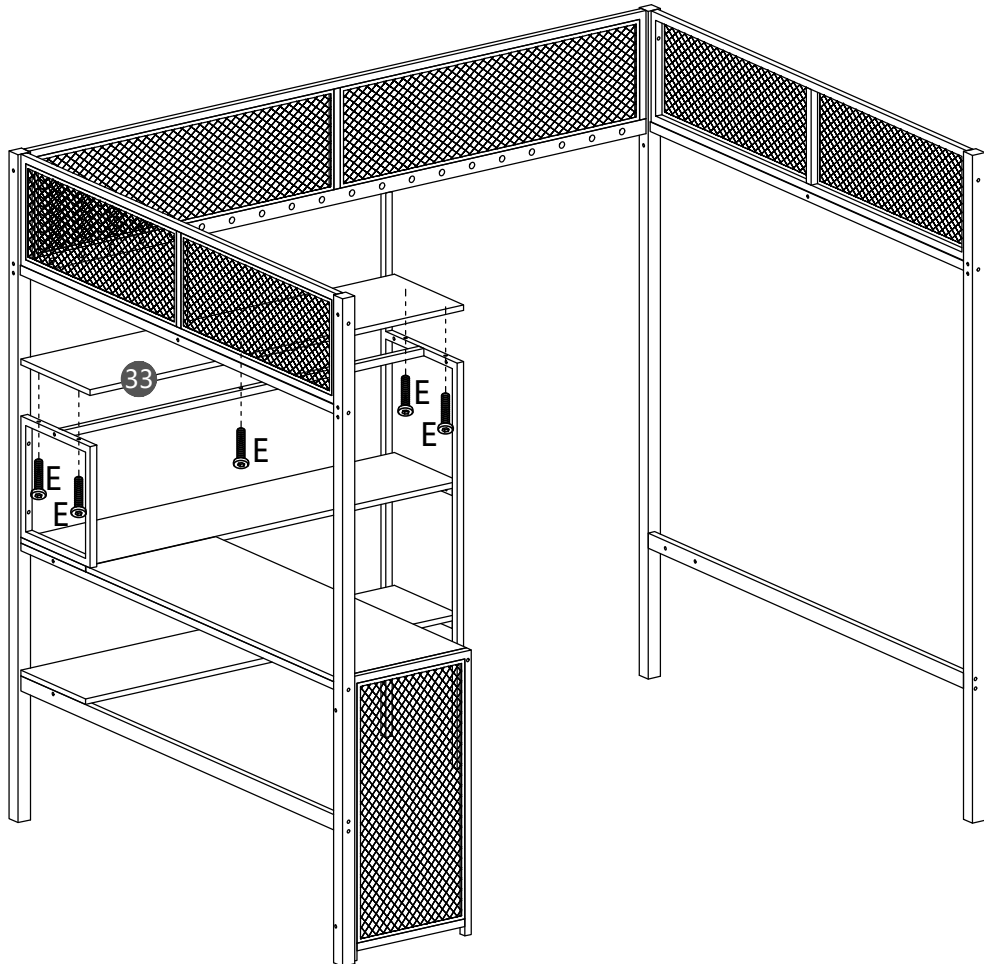

# STEP 12:

## Étape 12:

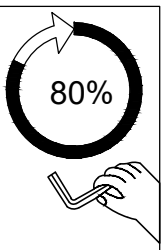

<b>E</b>

M6*30mm
5PCS

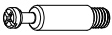
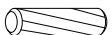

# STEP 13:

# Étape 13:

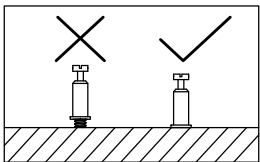
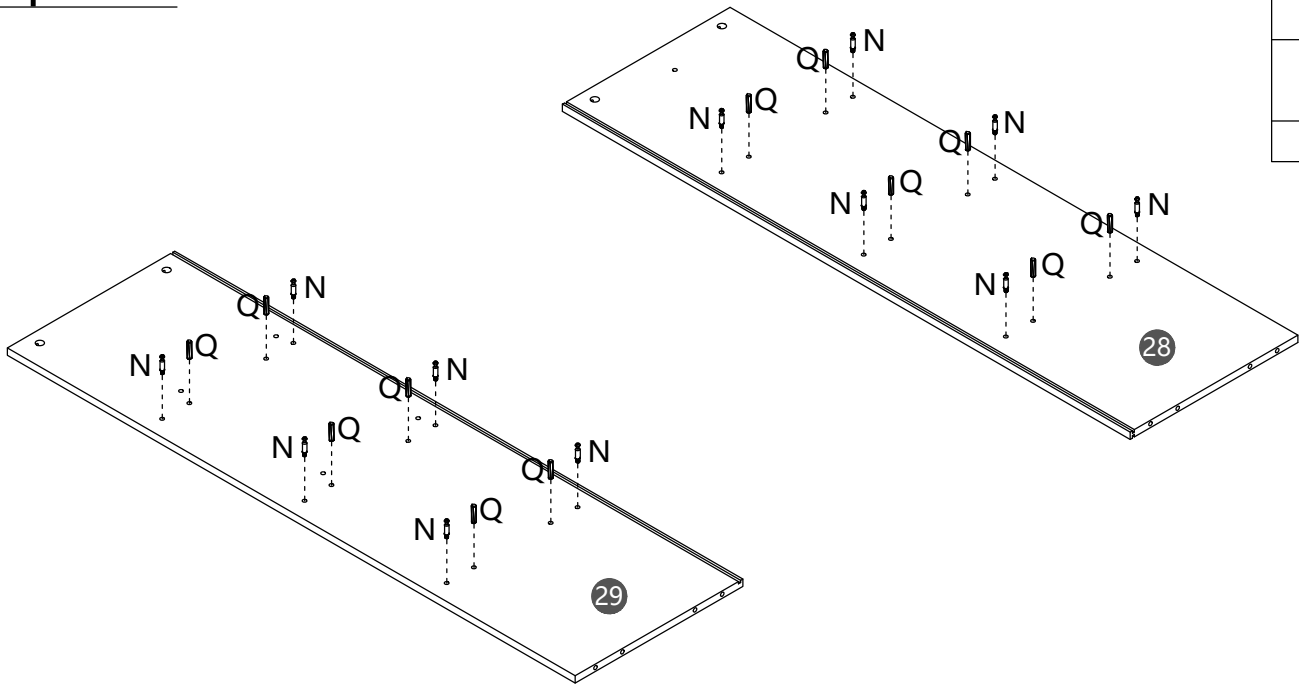
N

Ø6*35mm
12PCS
Q

Ø8*30mm
12PCS

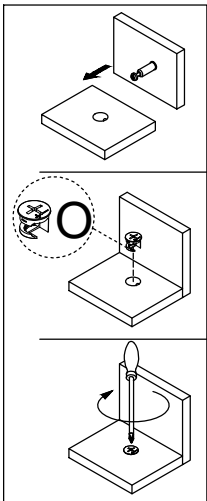
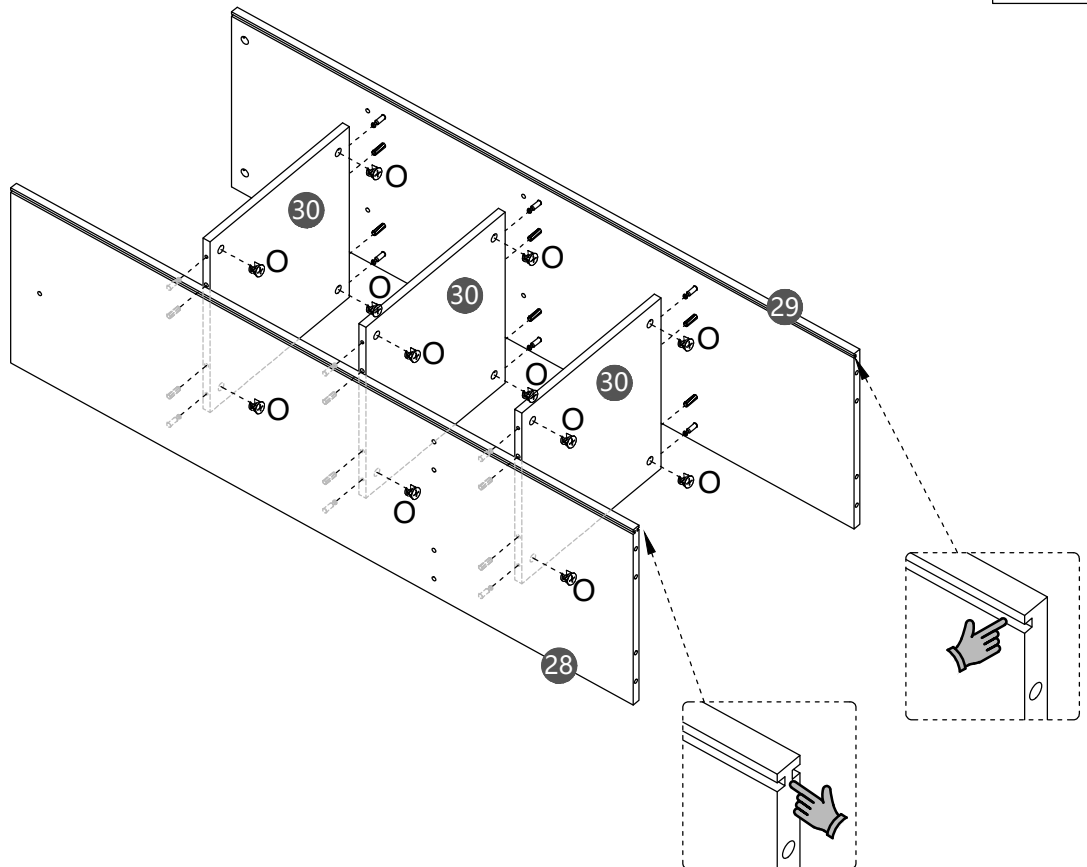

# STEP 14:

# Étape 14:

O

12PCS

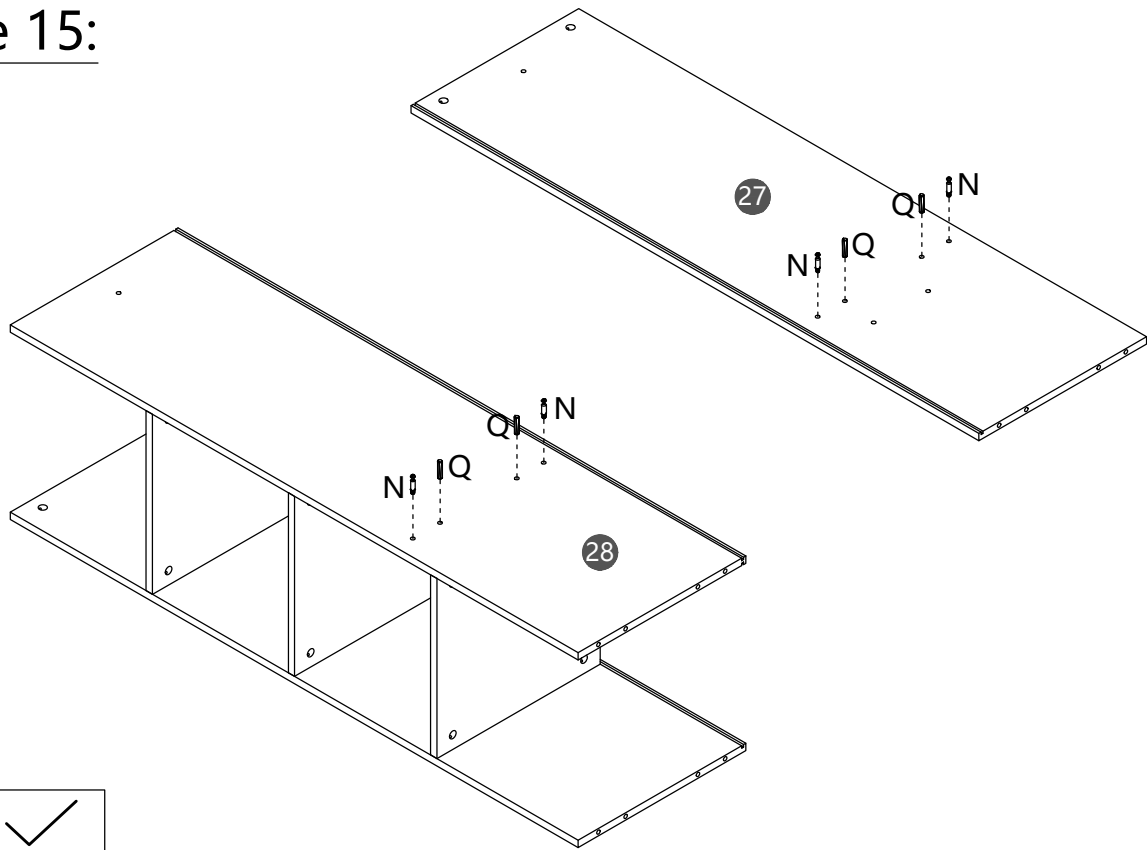

# STEP 15:

# Étape 15:

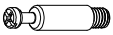
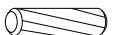



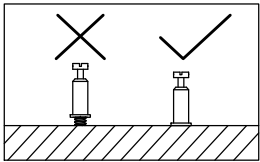

<b>N</b>

Ø6*35mm
4PCS
<b>Q</b>

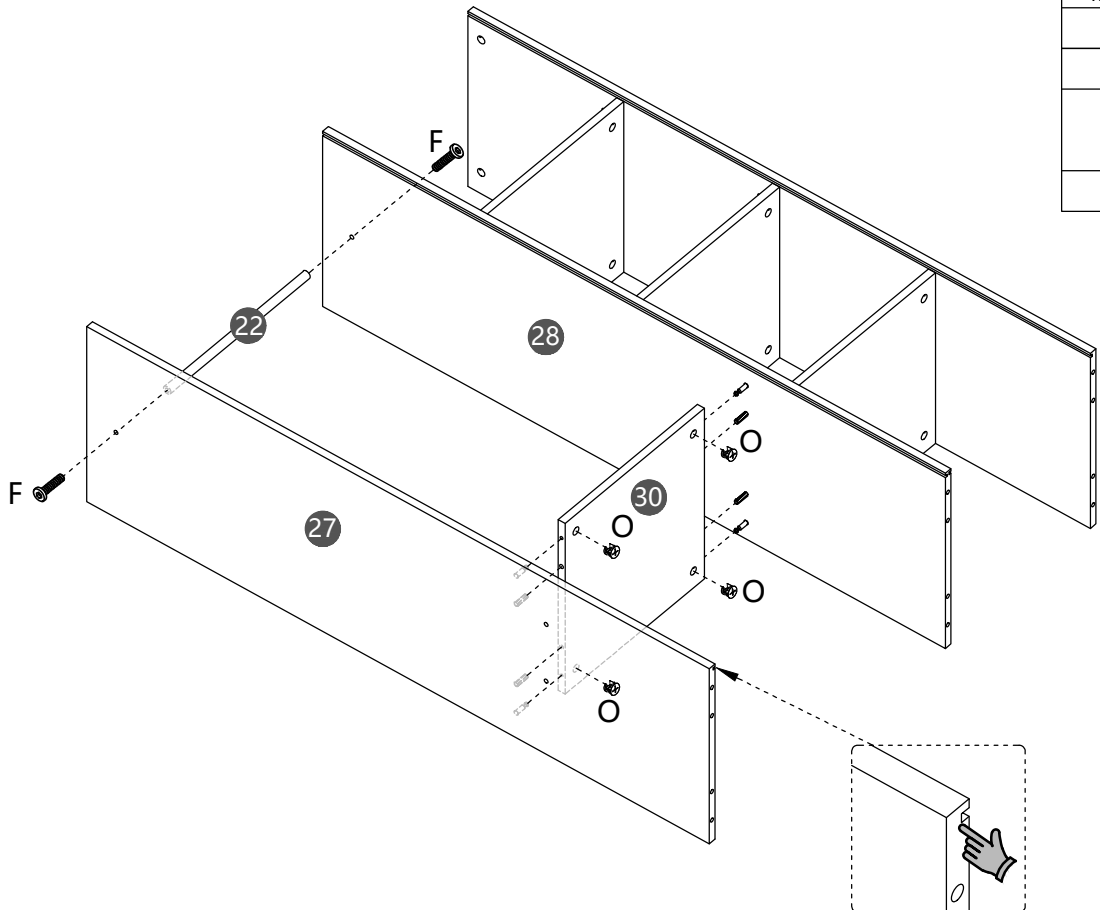
Ø8*30mm
4PCS



# STEP 16:

# Étape 16:



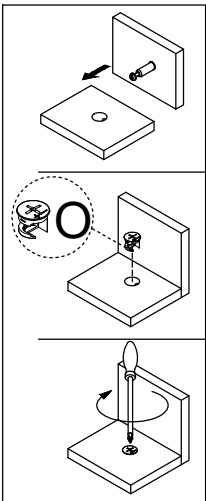

<b>F</b>

M6*28mm
2PCS

4PCS

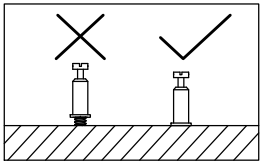
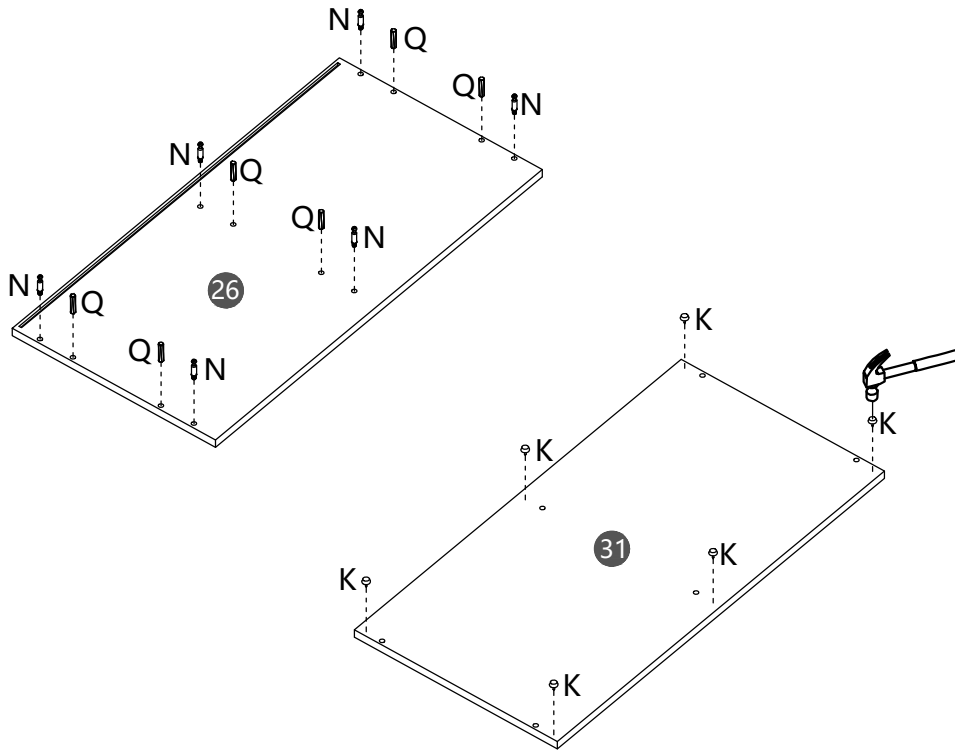

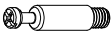
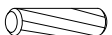
# STEP 17:

# Étape 17:



N

Ø6*35mm
6PCS
Q

Ø8*30mm
6PCS
K

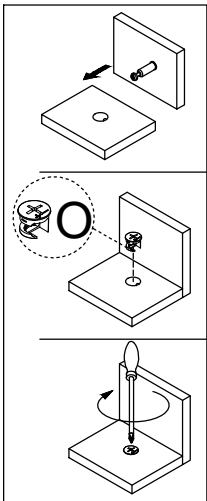
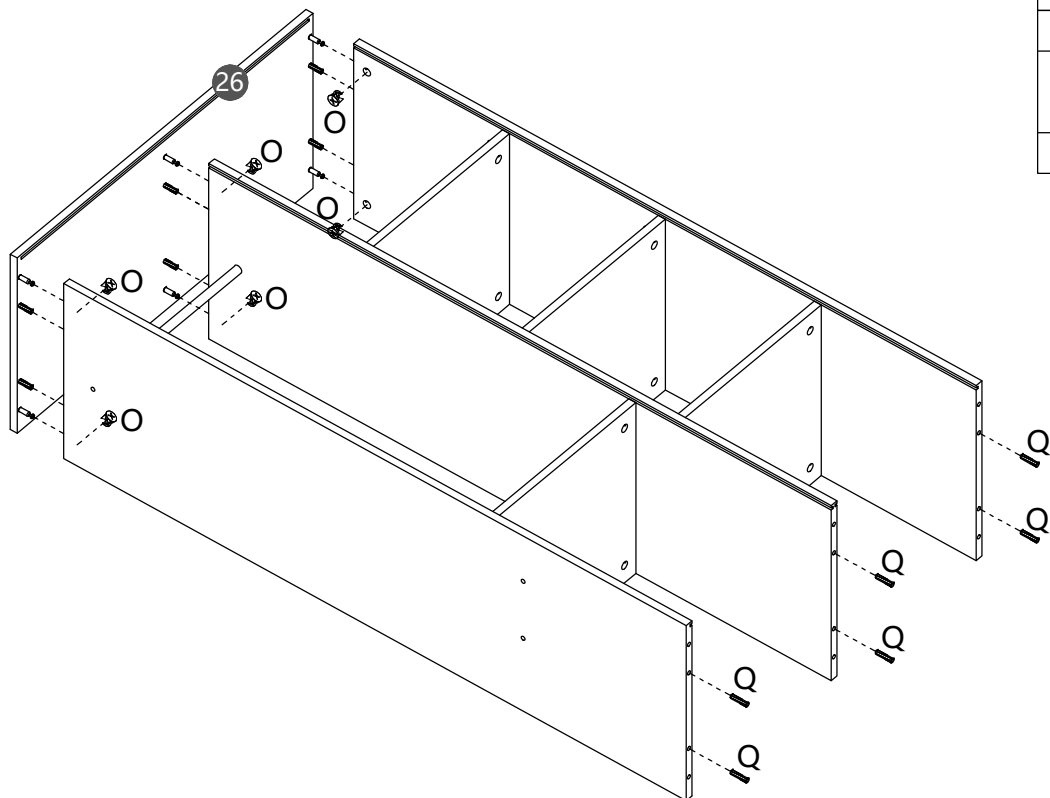
6PCS

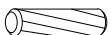
# STEP 18:

# Étape 18:



O

6PCS
Q

Ø8*30mm
6PCS

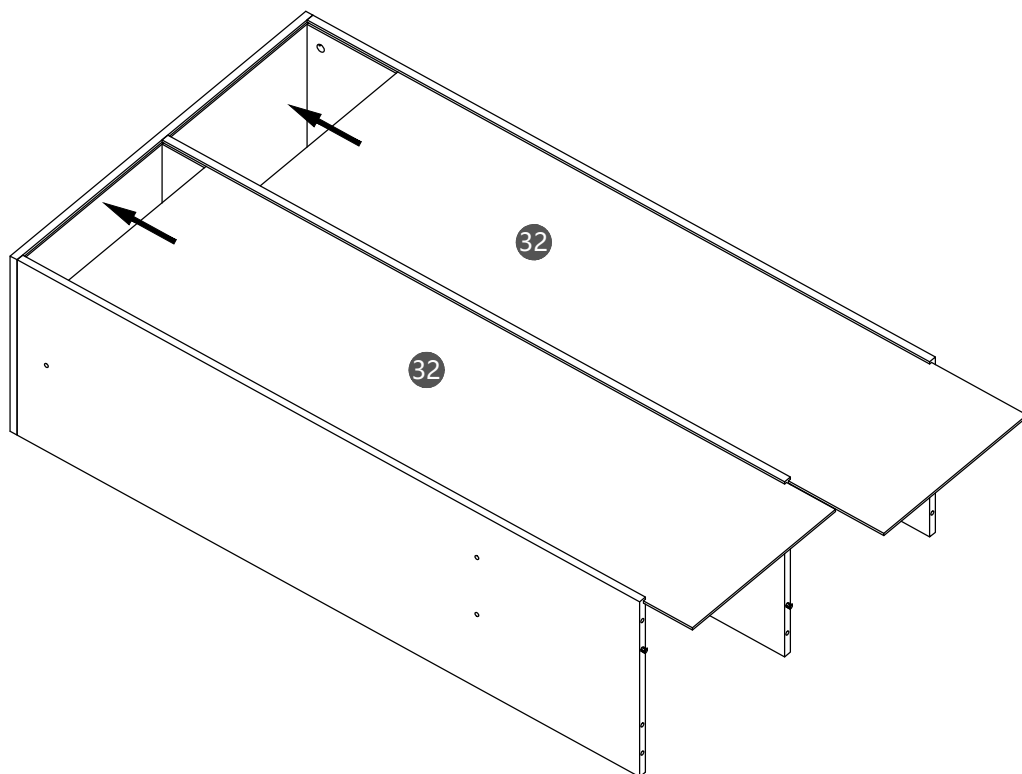
STEP 19:

Étape 19:



STEP 20:

Étape 20:

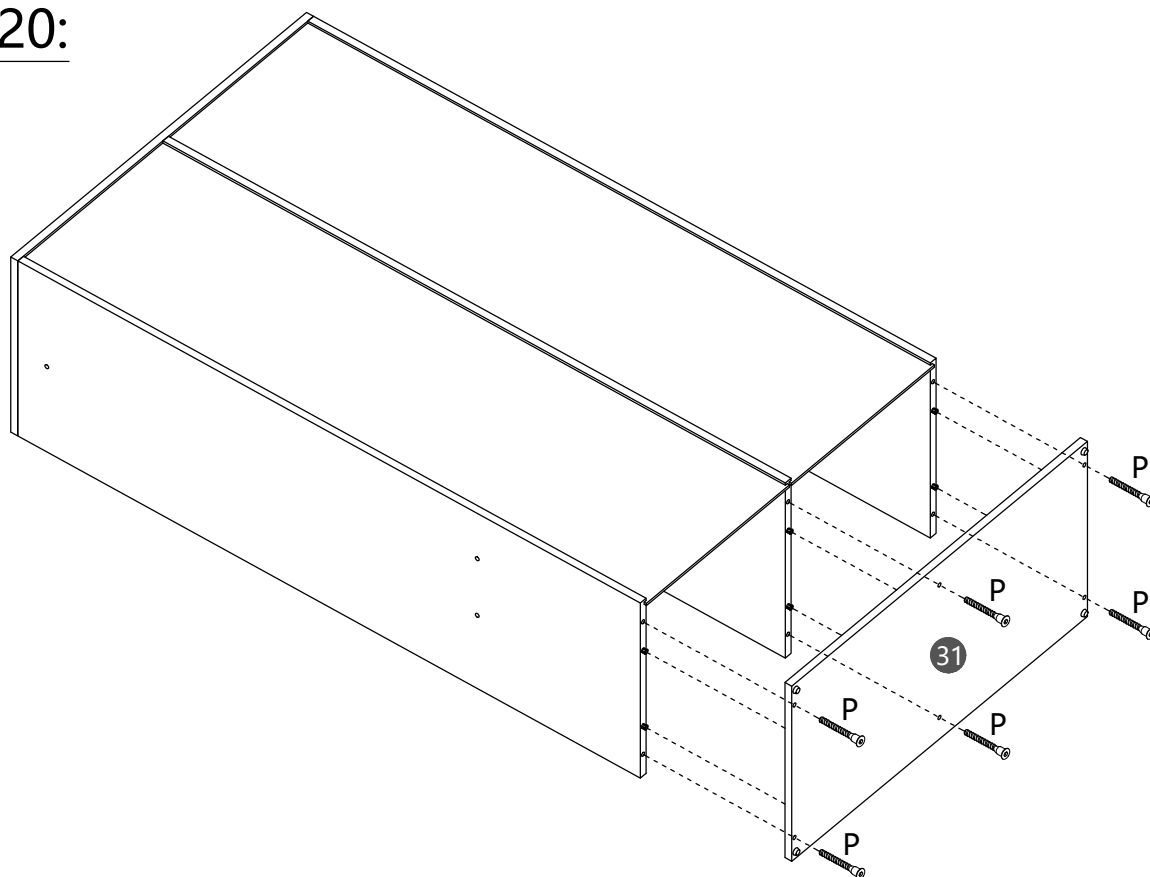

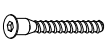

P

Ø7*40mm
6PCS

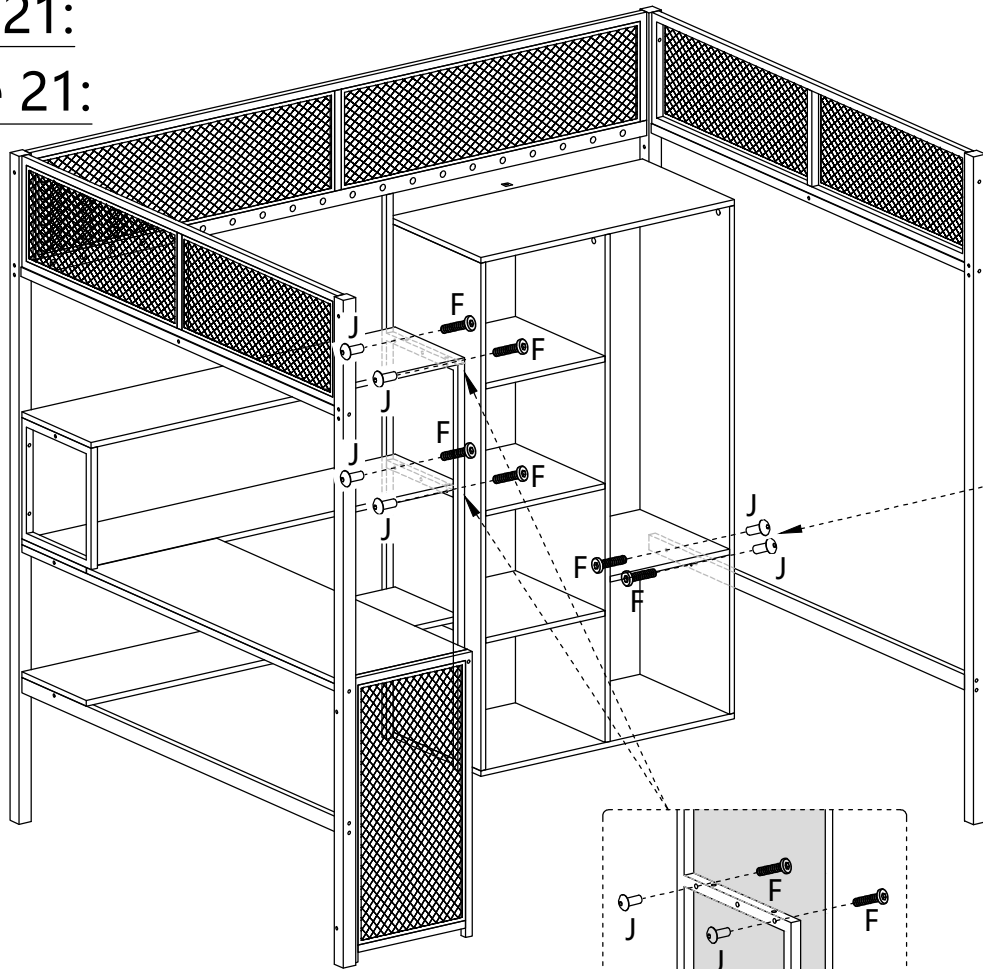
# STEP 21:

## Étape 21:



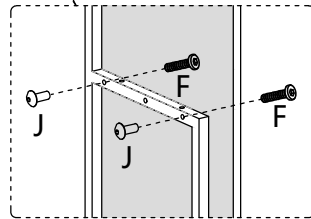
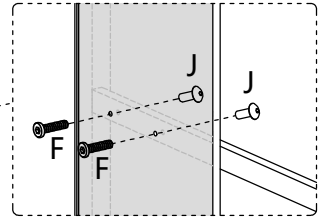

F

M6*28mm
6PCS
J

6PCS

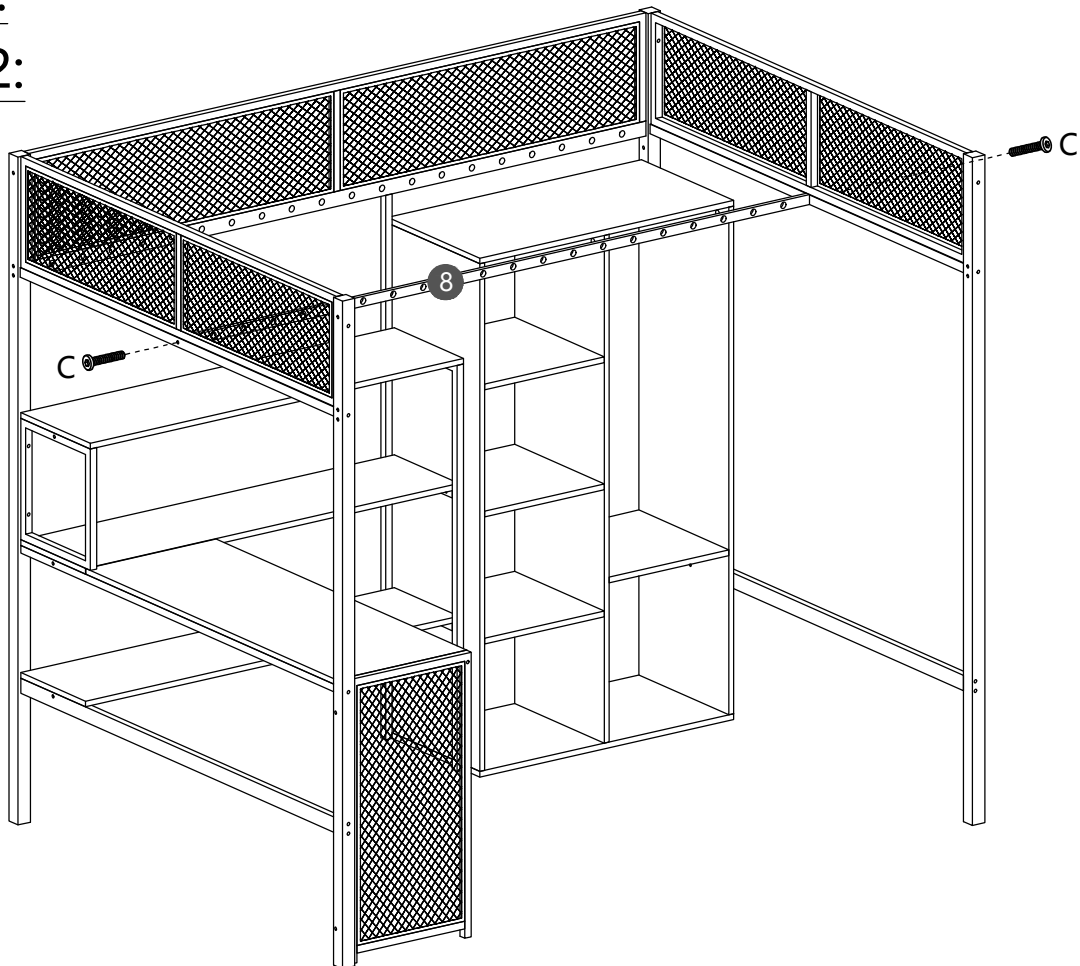

# STEP 22:

## Étape 22:



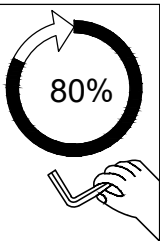

C

M6*45mm
2PCS

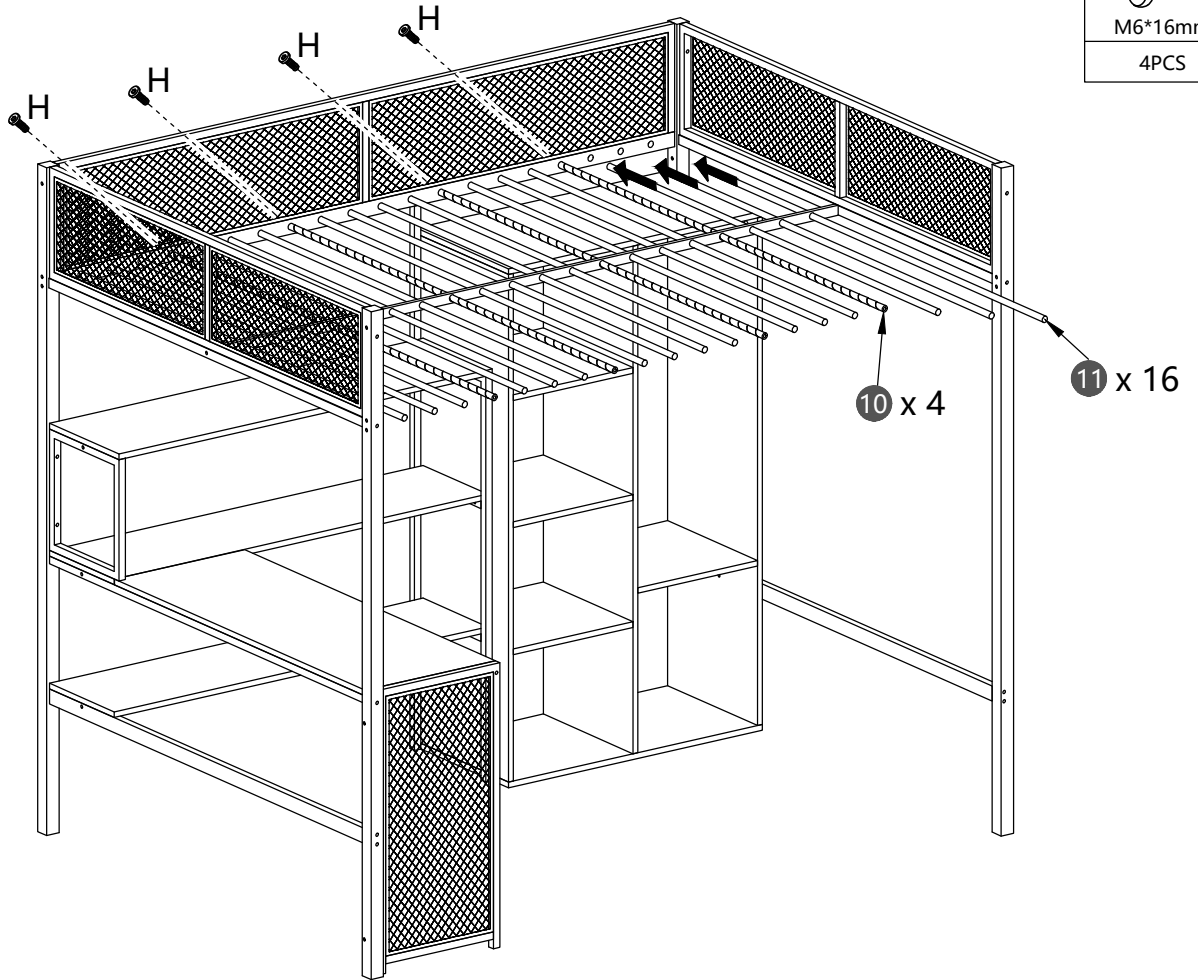

# STEP 23:

# Étape 23:





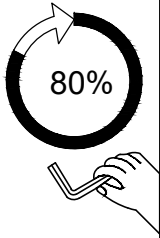

H

M6*16mm
4PCS

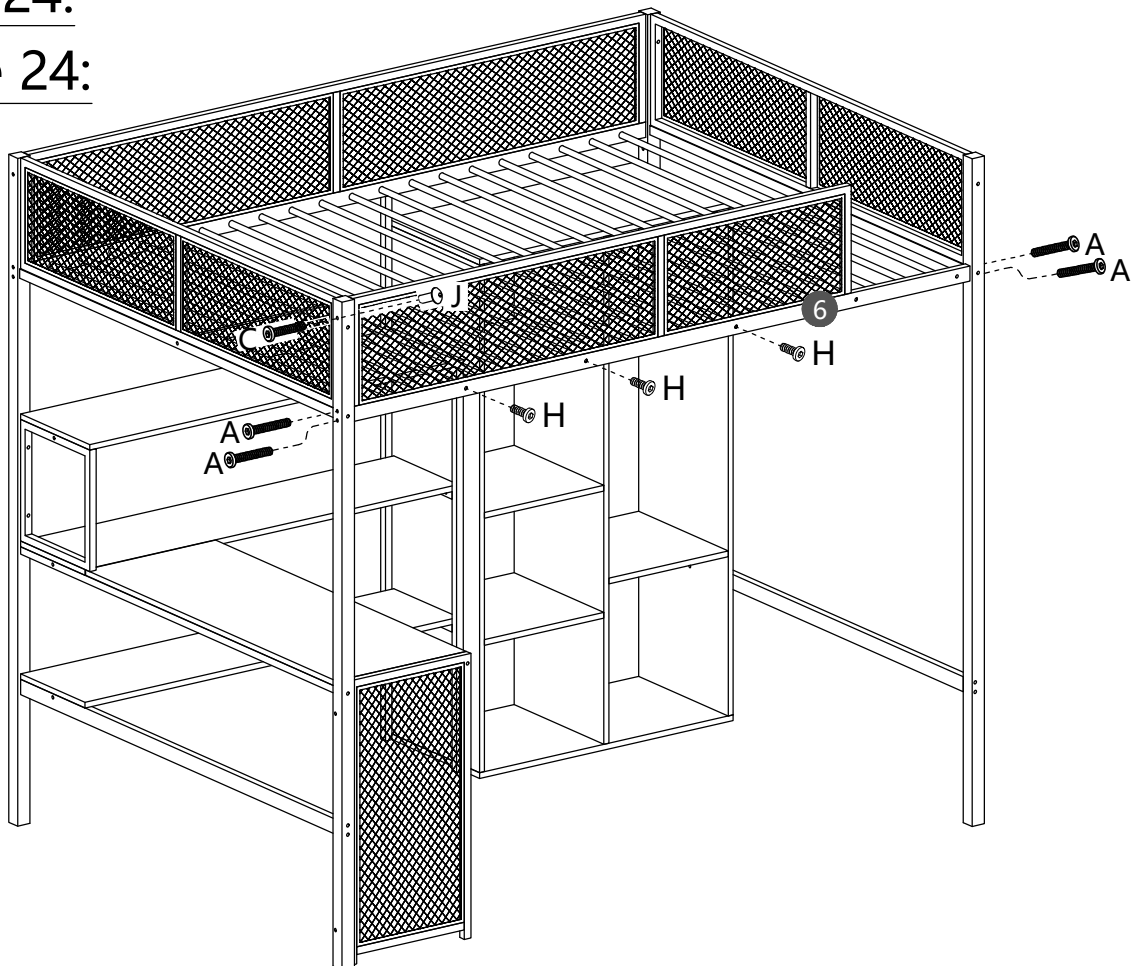

# STEP 24:

# Étape 24:





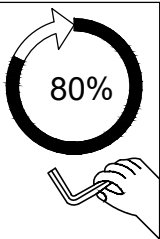

A

M6*60mm
4PCS
H

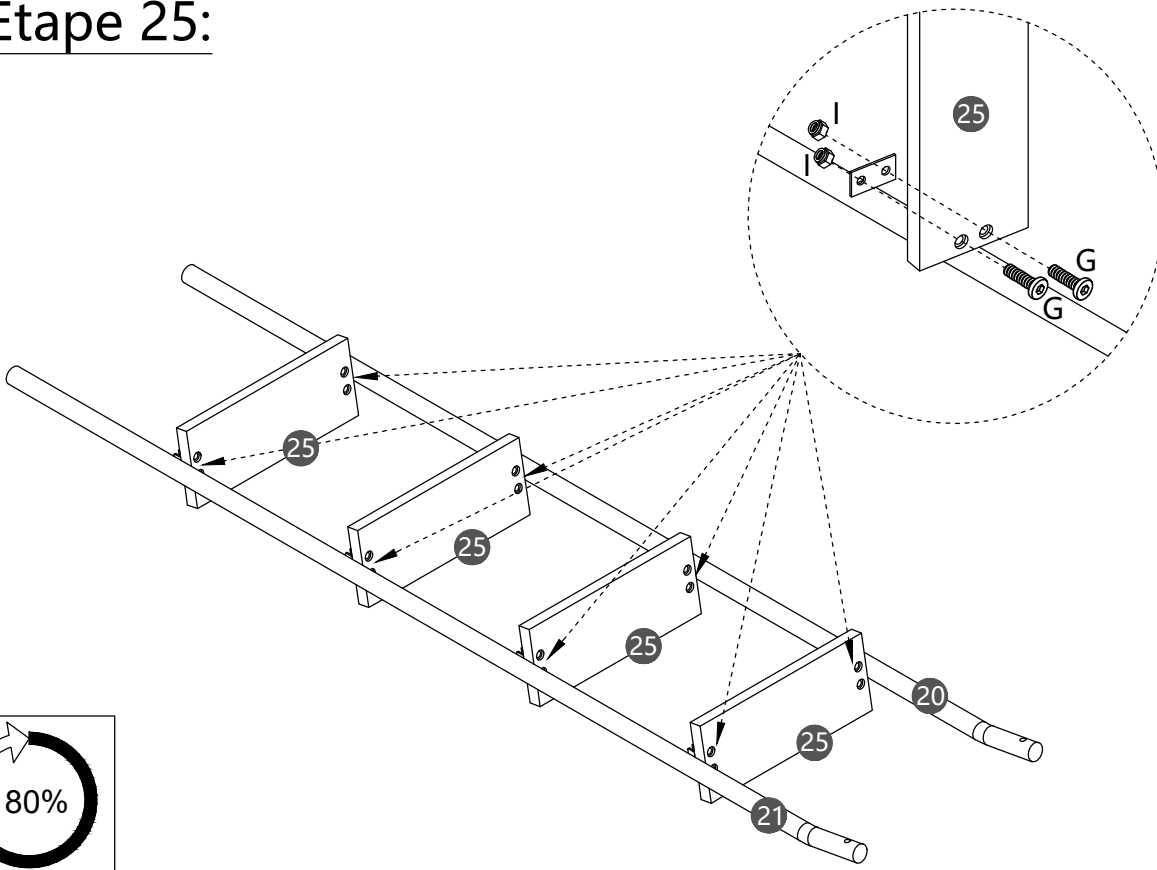
M6*16mm
3PCS
C

M6*45mm
1PC
J

1PC



# STEP 25:

## Étape 25:





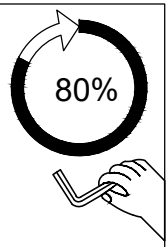

<b>G</b>

M6*25mm
16PCS
<b>I</b>

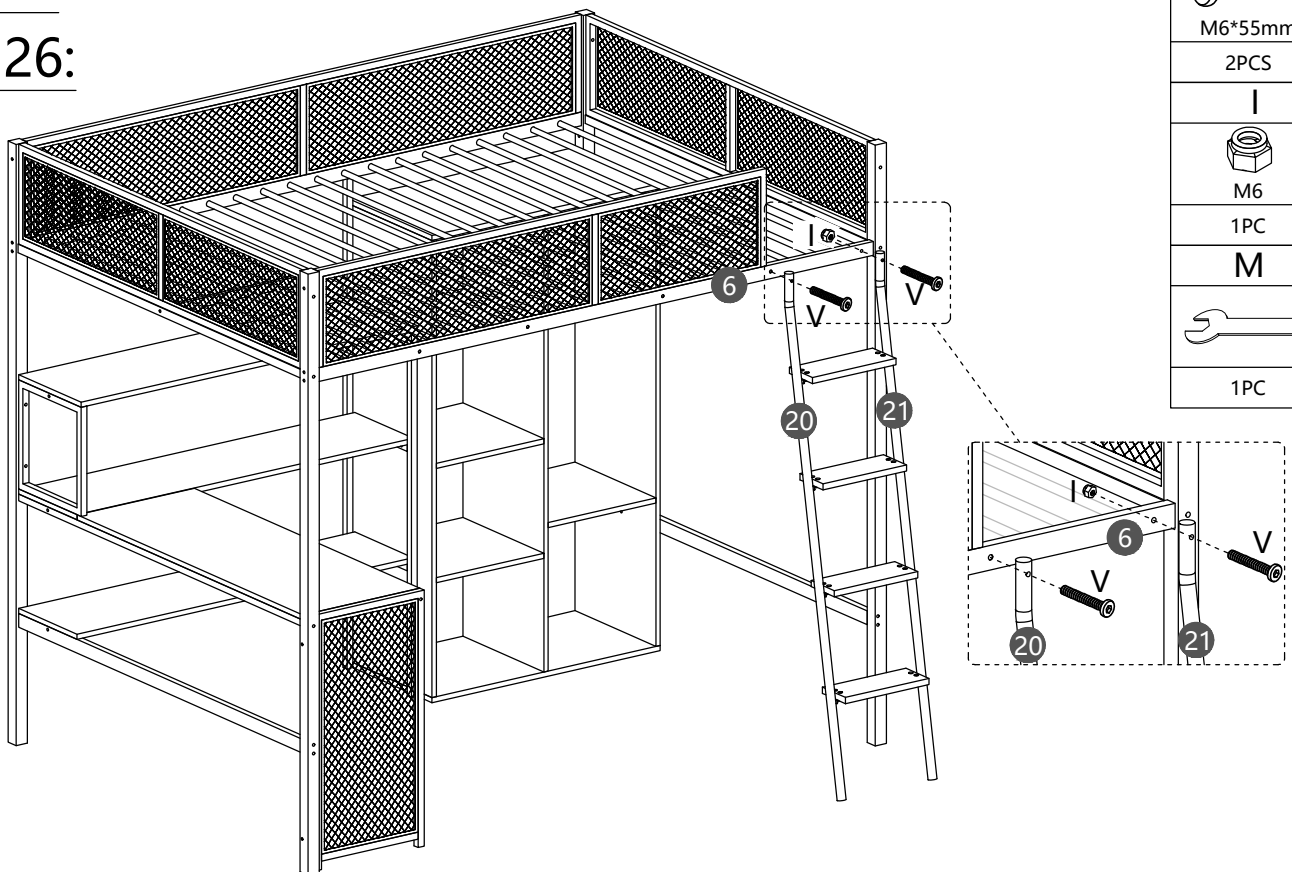
M6
16PCS
<b>M</b>

1PC



# STEP 26:

## Étape 26:



<b>V</b>

M6*55mm
2PCS
<b>I</b>

M6
1PC
<b>M</b>

1PC



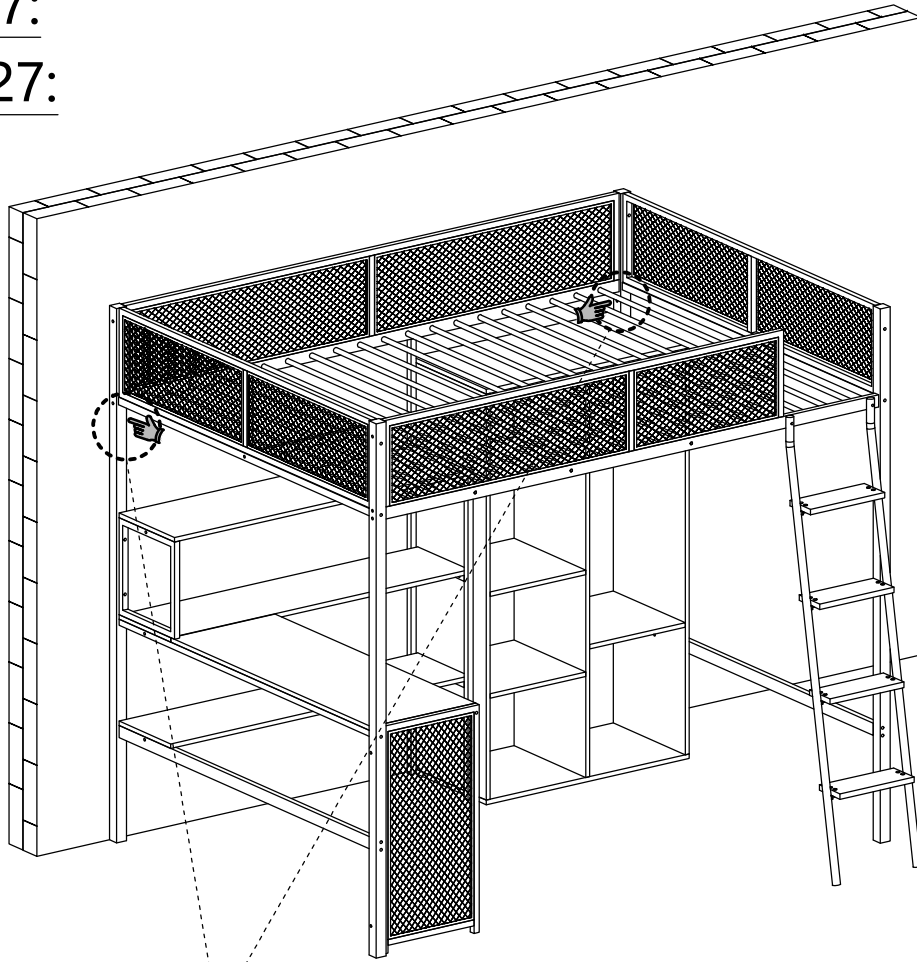

Tighten all the bolts.  
Serrez tous les boulons.

# STEP 27:

## Étape 27:

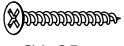

R	S
	 Ø4x35mm
2PCS	2PCS
U	T
	 Ø4x14mm
2PCS	2PCS

