

FOOSBALL TABLE

54" Table

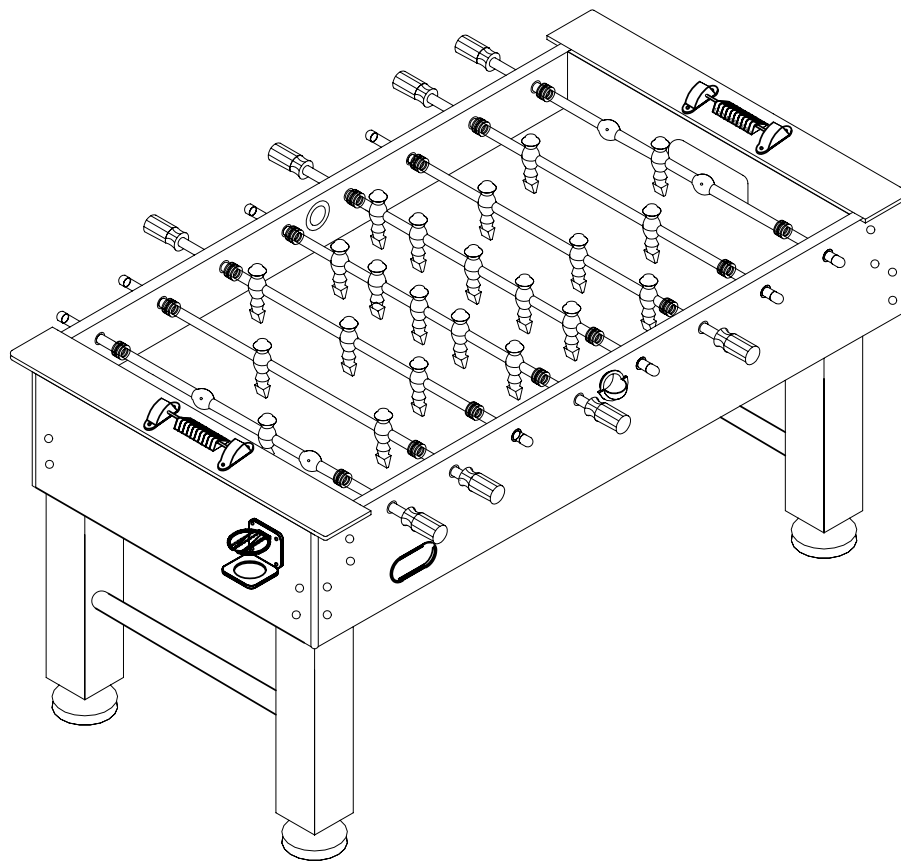

HARDWARE

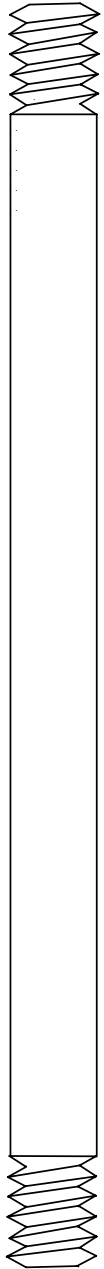
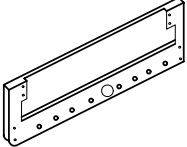
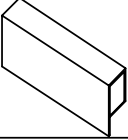
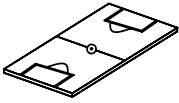
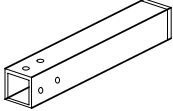
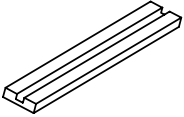
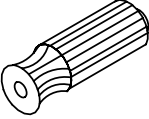
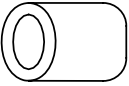

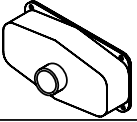

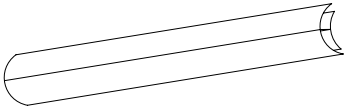
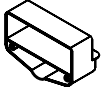
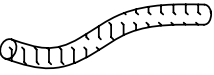
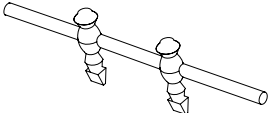
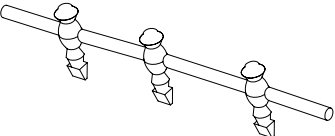
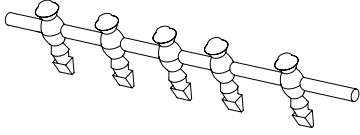
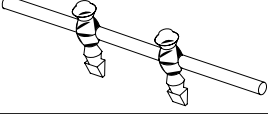
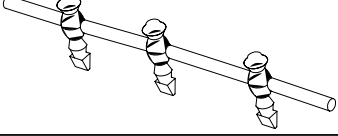
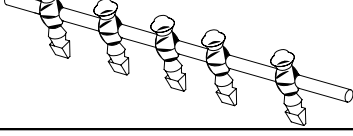
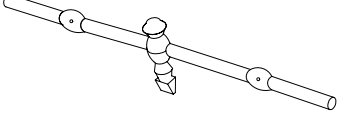
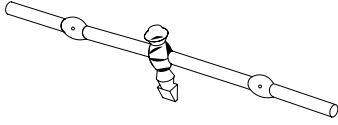
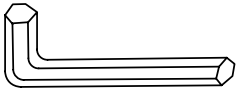



IMAGE		DESCRIPTION	QUANTITY
	H1	SUPPORT ROD	3
	H2	5/16" FLAT WASHER	24
	H3	1/4"NUT	6
	H4	5/16"X2-1/4" BOLT	24
	H5	3/16"X3/4" FLAT HEAD PHILLIPS SCREW	8
	H6	1-1/2"ROUND HEAD PHILLIPS SCREW	18
	H7	1/2"ROUND HEAD PHILLIPS SCREW	30
	H9	1" FLAT HEAD PHILLIPS SCREW	4
	H10	LEG LEVELER	4





COMPONENTS

IMAGE		DESCRIPTION	QUANTITY
	P1	SIDE PANEL	2
	P2	END PANEL	2
	P3	PLAYING FIELD	1
	P4	LEG	4
	P5	PLAY FIELD SUPPORT BRACE	3
	P6	ROD HANDLE	8
	P7	ROD END CAP	8
	P8	BALL ENTRY CUP	2
	P9	BALL CATCHER	2
	P10	SLIDE SCORER	2
	P11	CORNER	4
	P12	GOAL	2
	P13	BALL RUNNER	2

COMPONENTS

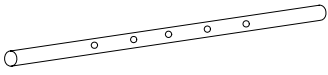
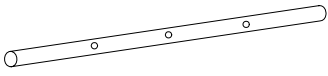
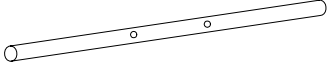
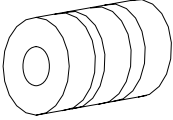
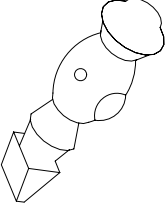
IMAGE		DESCRIPTION	QUANTITY
	R1	2 HOME PLAYERS ROD	1
	R2	3 HOME PLAYERS ROD	1
	R3	5 HOME PLAYERS ROD	1
	R4	2 AWAY PLAYERS ROD	1
	R5	3 AWAY PLAYERS ROD	1
	R6	5 AWAY PLAYERS ROD	1
	R7	1 HOME PLAYERS ROD	1
	R8	1 AWAY PLAYERS ROD	1
ACCESSORIES			QTY
	A1	TOOL	2
	A2	SOCCER BALL	2

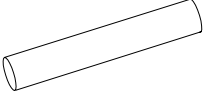
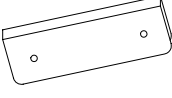
COMPONENTS

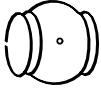
IMAGE		DESCRIPTION	QUANTITY
	C1	5 PLAYERS ROD	2
	C2	3 PLAYERS ROD	4
	C3	2 PLAYERS ROD	2
	C4	RUBBER BUSHING	16
	C5	AWAY MEN	12
	C6	HOME MEN	12
	C7	STICK	4
	C8	CROSS BAR	2
	C9	PANEL	2
	C10	CUP HOLDER	2
	C11	SLEEVE	4

ASSEMBLY INSTRUCTIONS

FOOSBALL TABLE ASSEMBLY

WARNING: TWO ADULTS NEEDED FOR ASSEMBLY

IMPORTANT:

Please read through the instruction book before attempting assembly to familiarize yourself with all part and assembly steps.

- 1** CUT CORNERS OF THE BOX TOP AND PLACE IT ON THE FLOOR TO PROTECT THE PARTS AS THE UNIT IS BEING ASSEMBLED. PLACE SIDE PANELS ***P1*** UPSIDE DOWN WITH THE SLOT FACING INWARD AS SHOWN IN ***FIGURE 1A***.(BALL ENTRY HOLE WILL BE CLOSEST TO THE FLOOR.) TO EASE ASSEMBLY PUSH THE PRE-ASSEMBLED BUSHINGS AND PLASTIC WASHERS ON THE RODS UP AGAINST THE MEN. AT THIS TIME DO NOT CUT THE RUBBER BANDS THAT HOLD THE ASSEMBLY TOGETHER. ALIGN THE RODS AS SHOWN IN ***FIGURE 1A***. THE HANDLE ENDS OF THE RODS ARE THE ENDS WITH THE HOLES APPROX. 1/2"FROM THE END.

REMEMBER:

You are working upside down. All of the home team must face one direction and the away team the opposite direction. All home team handles will go on one side, all the away team on the other side. The handle ends are the ends with the holes approx. 1/2" from the end of the rod.

- 2** INSERT THE RODS THROUGH THE ROD BUSHINGS IN ONE SIDE PANEL AS SHOWN IN ***FIGURE 1A***.

ZOOM FOOSBALL TABLE ASSEMBLY

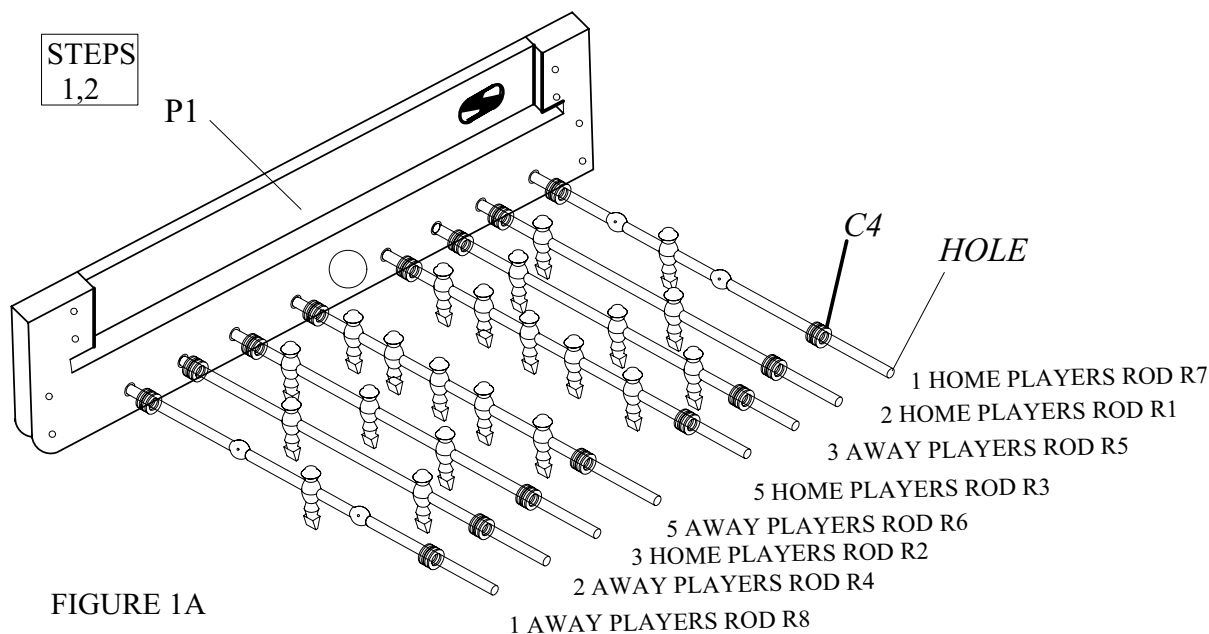

FIGURE 1A

- 3 ATTACH THE TWO END PANELS **P2** TO THE SIDE PANELS **P1** AS SHOWN IN **FIGURE 2**. **REMEMBER THE GROOVE MUST FACE INWARD TOWARD THE PLAY FIELD**. INSERT THE BENDS (P11) INTO THE SIDE PANELS (P1) & END PANELS (P2) SEE **FIGURE 1B**.
- 4 ATTACH THE END PANELS WITH BOLTS (**H4**) AND WASHERS (**H2**) INTO THE PRE-INSTALLED DOWEL CONNECTORS. TIGHTEN ALL HARDWARE AT THIS TIME. INSERT PLAYING FIELD (P3) INTO THE GROOVE ON THE SIDE PANELS (P1) WITH GRAPHICS FACING DOWN. SEE **FIGURE 1B**.

STEPS
3,4

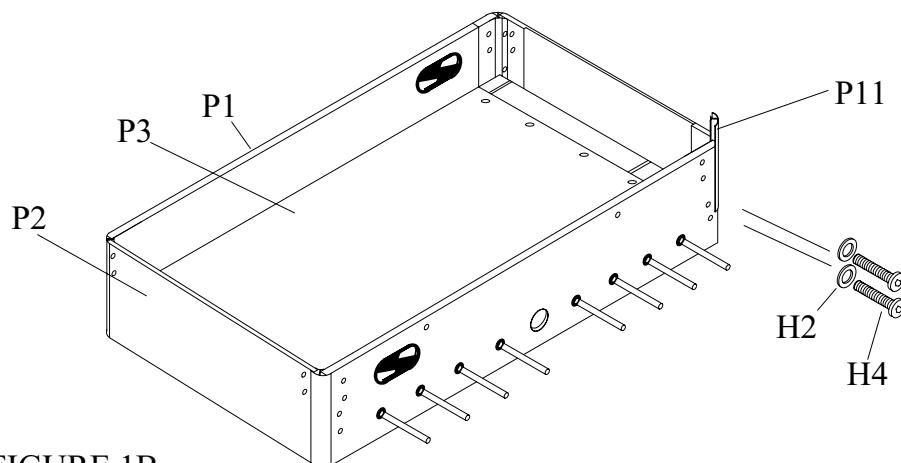

FIGURE 1B

ZOOM FOOSBALL TABLE ASSEMBLY

- 5** INSERT PLAYING FIELD SUPPORT BRACES (**P5**) INTO THE NOTCHES ON THE SIDE PANELS. SLIDE THE SUPPORT RODS **H1** THROUGH THE GROOVE IN THE SUPPORT BRACES. SECURE WITH NUT (**H3**).
DO NOT TIGHTEN AT THIS TIME! SEE **FIGURE 2**.

- 6** ATTACH PLAY FIELD WITH EIGHT SCREWS (**H6**) IN THE ENDS AS SHOWN IN **FIGURE 2**.

STEP
5,6

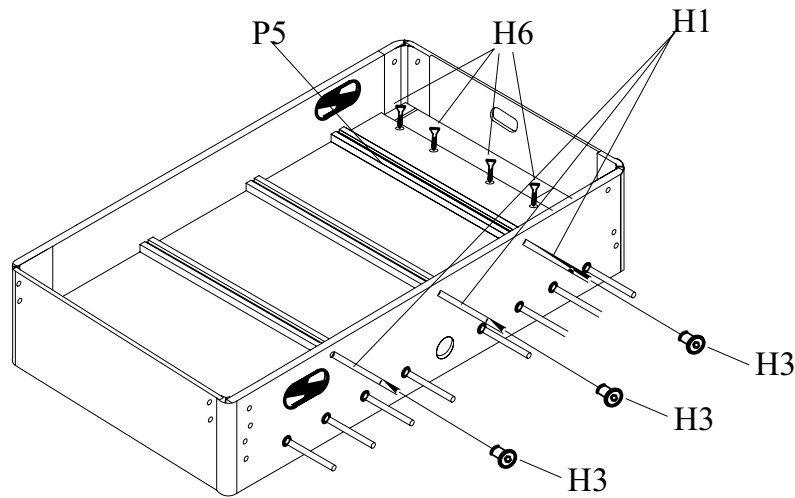

FIGURE2

- 7** INSERT CROSS BAR (**C8**) INTO LEGS (**P4**) AS SHOWN IN **FIGURE 3A**.

STEP
7

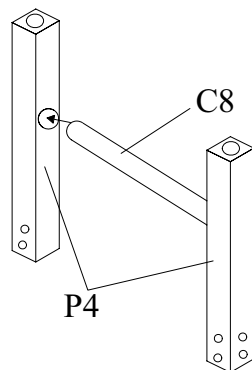

FIGURE 3A

ZOOM FOOSBALL TABLE ASSEMBLY

CAUTION

Do not over-tighten hardware!

8

AFFIX THE GOAL (P12) TO THE END PANEL WITH THE ½" PHILLIPS ROUND HEAD SCREWS (H7). AFFIX THE BALL CATCHER (P9) TO THE SIDE PANEL WITH THE ½" PHILLIPS ROUND HEAD SCREWS (H7). CONNECT THE GOAL TO THE BALL CATCHER WITH THE BALL RUNNER (P13)

CONNECT THE WIRES FROM THE END PANEL TO THE CONTROL PANEL.
CONNECT THE WIRES FROM THE GOAL TO THE CONTROL PANEL.

9

ATTACH THE LEGS (P4) TO THE CORNERS OF THE SIDE AND END PANELS USING THE 5/16" BOLT (H4) AND 5/16" WASHER (H3). SCREW THE LEG LEVELERS (H10) INTO THE BOTTOM OF THE LEGS.

WARNING

PLEASE VERY CAREFULLY TURN THE TABLE OVER AND SET ON ITS LEGS. BE CAREFUL THE TABLE IS VERY HEAVY AND THE RODS WILL SLIDE. DO NOT LIFT THE TABLE BY HOLDING ONTO THE RODS.

STEP
8,9

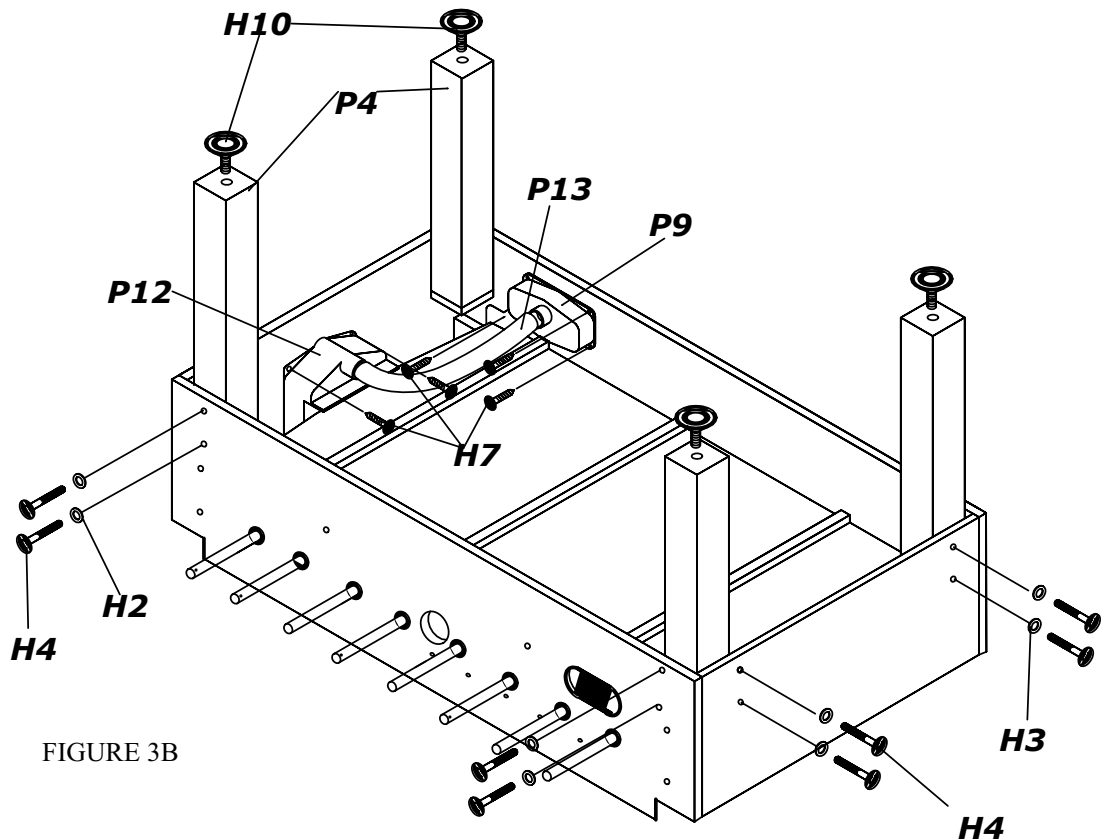

ZOOM FOOSBALL TABLE ASSEMBLY

10

ATTACH BALL ENTRY CUPS **P8** TO THE SIDE PANELS WITH SCREWS **(H7)** AS SHOWN IN **FIGURE 4A**. SLIDE THE HANDLES **(P6)** ONTO THE END OF THE RODS WITH THE HOLE CLOSE TO THE END (THE HOLE MAY NOT GO COMPLETELY THROUGH THE ROD!). SLIDE THE RUBBER END CAPS **(P7)** ONTO THE **OTHER** END OF THE RODS.

ATTACH THE CUP HOLDER **(C10)** TO THE END PANEL USING THE 1/2" ROUND HEAD SCREWS **(H7)**. SEE **FIGURE 4A**.

11

ATTACH THE PANELS **(C9)** TO THE END PANEL USING ROUND HEAD STICK **(C7)**. SEE **FIGURE 4A**.

ATTACH THE **(P10)** TO THE END PANEL USING THE 2" ROUND HEAD SCREWS **(H9)**. SEE **FIGURE 4B**.

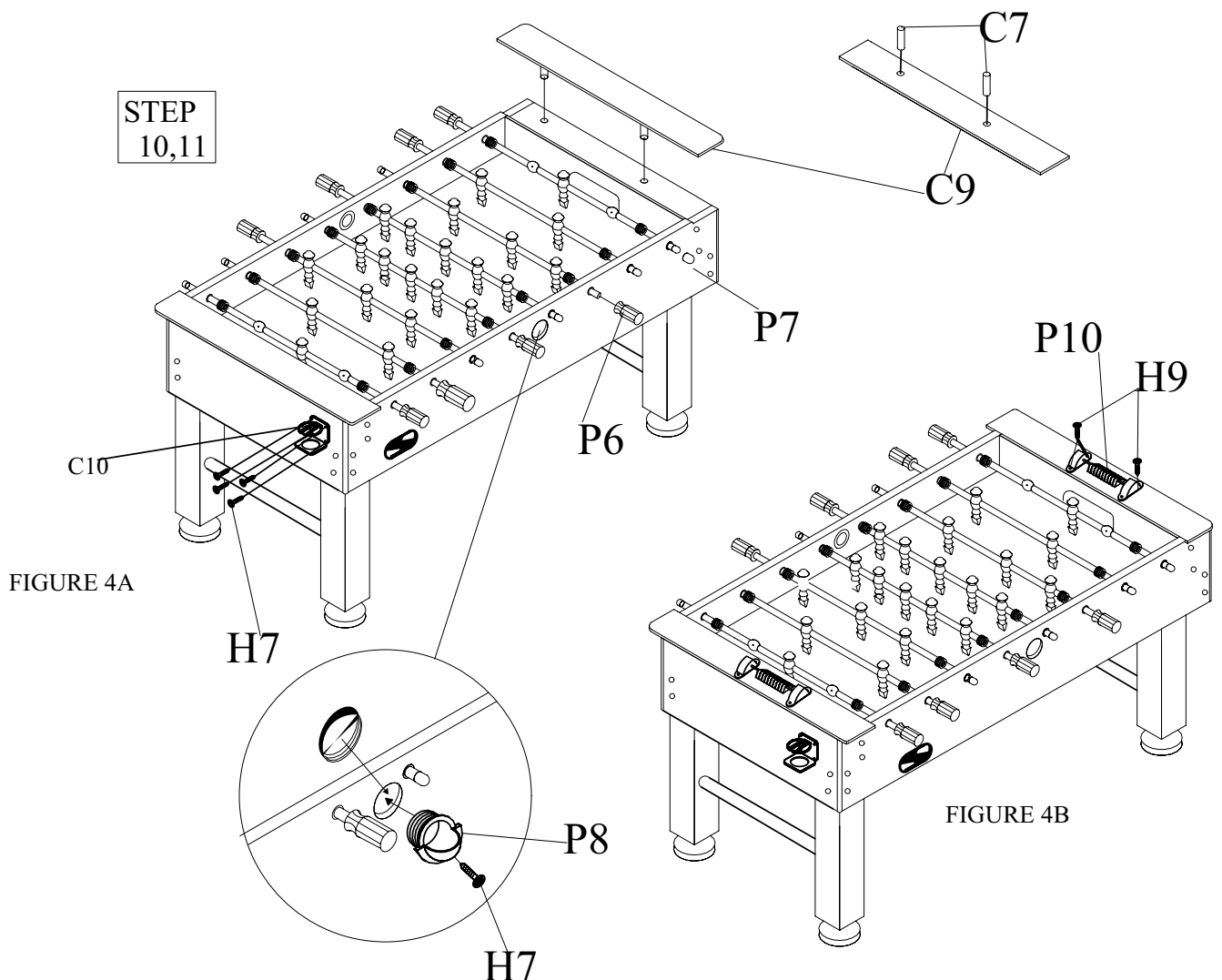

ZOOM FOOSBALL TABLE ASSEMBLY

12

ATTACH THE HANDLES (P6) ONTO THE END OF THE RODS WITH SCREWS(H5). AS SHOWN IN **FIGURE 5**.

STEP
12

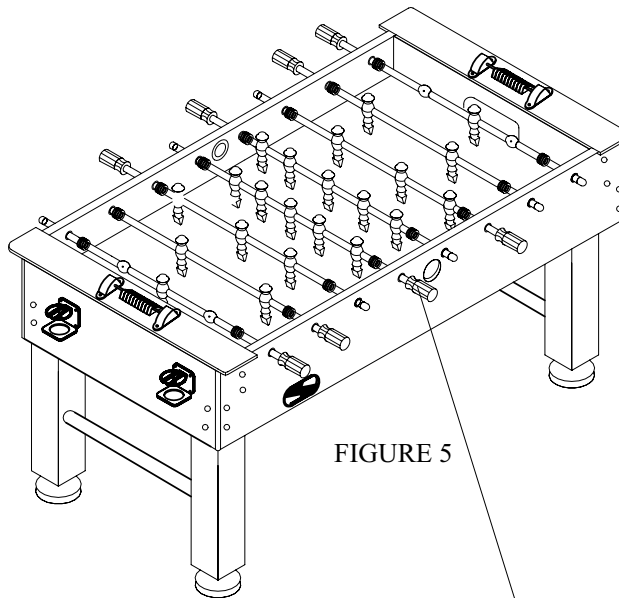
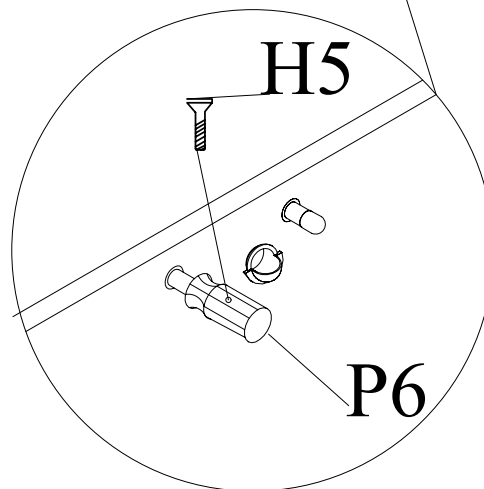

FIGURE 5



FOOSBALL GAME RULES

Table soccer is also called "foosball". It can be played by two teams of **two** players each or by two individuals.

The object of the game:

To be the first team (or player) to score a predetermined number **or** to score the most **points** in **a** given amount of time.

How to play:

Serving:

The server rolls the ball through the serving hole to start the game, after a ball leaves the table. The server can spin the ball to influence the serve, but the ball must be struck by one of the serving teams (or server's) player figures. Once the ball is in play, it remains in play until it is hit off the table, a dead ball is declared, time out is called, or a point is scored.

Passing:

If a ball is pinned on the 5-man rod, it cannot be passed to the 3-man rod of the same team without touching at least two player figures as it is being passed.

Scoring:

When a ball enters the opposing team's goal, a point is scored. If the ball enters the goal, but bounces back onto the playing surface or leaves the table, it still counts as a goal.

Spinning Rods: Spinning the rods is illegal.

Ball off the Table:

If the ball leaves the playing surface and strikes any object that is not part of the table, it is declared "off the table" and should be put back into play by a serve from the team (or player) that originally **served** that ball. If the ball rolls into the serving cup and then returns to the playing surface it is still considered "in play".

Dead Ball:

If the ball has completely stopped its motion and cannot be reached by any player figure, it is declare a "dead ball". If the ball is declared dead between the goal and the 2-man rod, it should be put back into play by placing it in nearest comer and releasing it. If the ball is declared dead anywhere else on the playing surface, it should be put back into play by a serve from the team that originally served the ball. If a ball is spinning in place, it is not considered a dead ball.

Helpful Hints:

If the rods do not slide freely you can spray furniture polish on a rag and wipe down the rods, this will make them slide easier. If the playfield has a slight warp you can loosen the nuts H3 on the rods H1 to help relax the playfield.

A drop of liquid soap will help slide the handles P6 onto the rods.