

Assembly Instructions

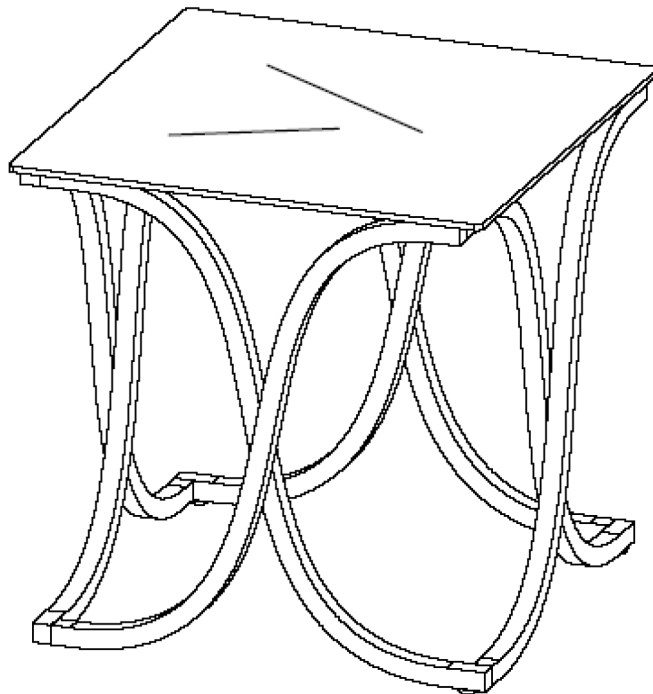

ASSEMBLY RATING

The Assembly Rating is a 5-point system that shows the degree of effort needed in assembling a specific product (with 1 being easy and 5 being difficult). For some products, two persons are recommended.

Tools Required for Assembly:

Allen Wrench



EASY  DIFFICULT

ASSEMBLY & CARE ADVICE

FOR YOUR FURNITURE TO LAST, CORRECT ASSEMBLY AND PROPER MAINTENANCE ARE NECESSARY. PLEASE FOLLOW THE INFORMATION PROVIDED BELOW TO FULLY ENJOY YOUR FURNITURE.

BASIC ASSEMBLY TECHNIQUES



1 When lock or spring washer is used in an assembly, please make sure the lock or spring washer is placed between the larger flat washer and the head of the screw or bolt.



2 Position each part correctly and insert screws or bolts into their respective holes by hand tighten or using the proper hand tool. Only tighten when step is completed or when instructed to do so.



3 Use cardboard or carpet area when assembling furniture to prevent scratches. Make sure the furniture rests on a flat and level surface with each leg evenly touching the floor.



4 Some furniture comes with height adjustment knobs underneath each leg. To lower or to raise each leg, you need to turn clockwise or counterclockwise, respectively.



5 Make sure all parts are properly aligned, then use the appropriate hand tool to completely tighten the bolts or screws. Do not use power tools and do not overtighten.



6 Save the instructions and store the Allen wrench or any supplied tool for later maintenance. After two weeks, check and tighten any loose hardware and repeat again every six months thereafter.

IT IS THE USER'S RESPONSIBILITY TO MAINTAIN THE FURNITURE. THE HARDWARE MAY LOOSEN OVER TIME AND MAY CAUSE THE FURNITURE TO BE WOBBLY AND UNABLE TO SUPPORT ITS INTENDED WEIGHT CAPACITY. THIS MAY LEAD TO COLLAPSE AND MAY CAUSE SERIOUS INJURY.



FAILURE TO FOLLOW THE GUIDELINES ABOVE MAY RESULT IN INJURY AND/OR PROPERTY DAMAGE.

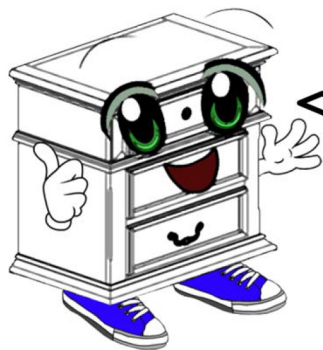

Before you begin, please read Page 2 of "Assembly and Care Advice".

And remember, do not tighten until each step is completed or instructed.

MD

Parts List

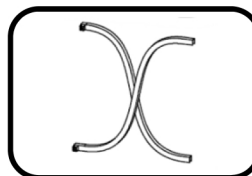

#1 x 4 pcs
Leg Stand

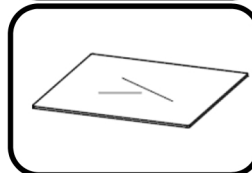

#2 x 1 pc
Glass Top

Hardware List

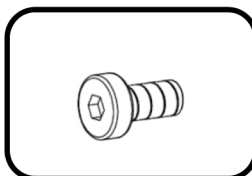

#A x 8 pcs
Bolt 1/4"x1/2"

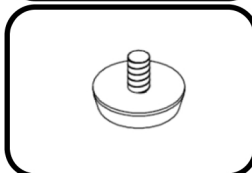

#B x 4 pcs
Leveler

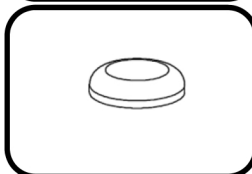

#C x 4 pcs
Spacer

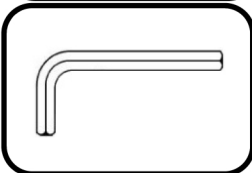

#D x 1 pc
Allen Wrench

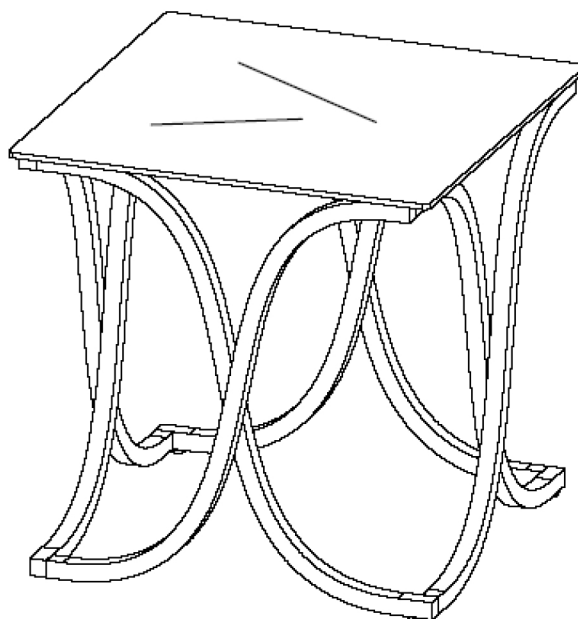



#1

#A x 4 pcs

Turn right (clockwise) to tighten

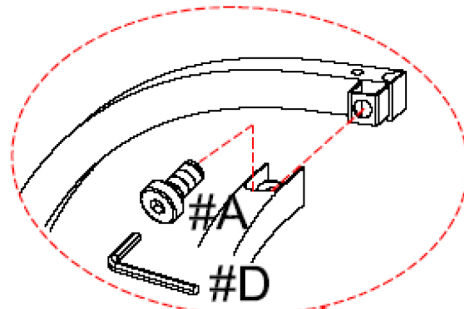

- I. Align the 2 leg stands (#1) with the third leg stand (#1).
- II. Insert 4 bolts (#A) through the leg stands (#1) and secure the bolts using the Allen wrench (#D) to lock the leg stands together.

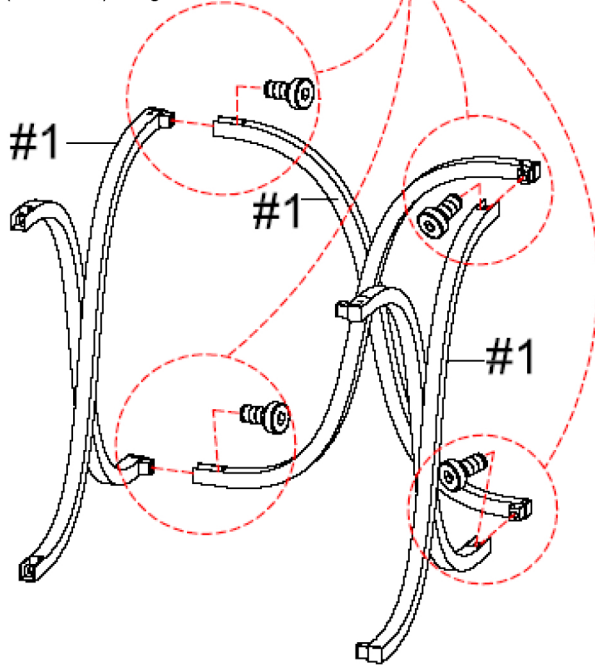

#2

Repeat the process in Step 1 to assemble the fourth leg stand (#1) onto the other ends of the leg stands (#1).

#A x 4 pcs

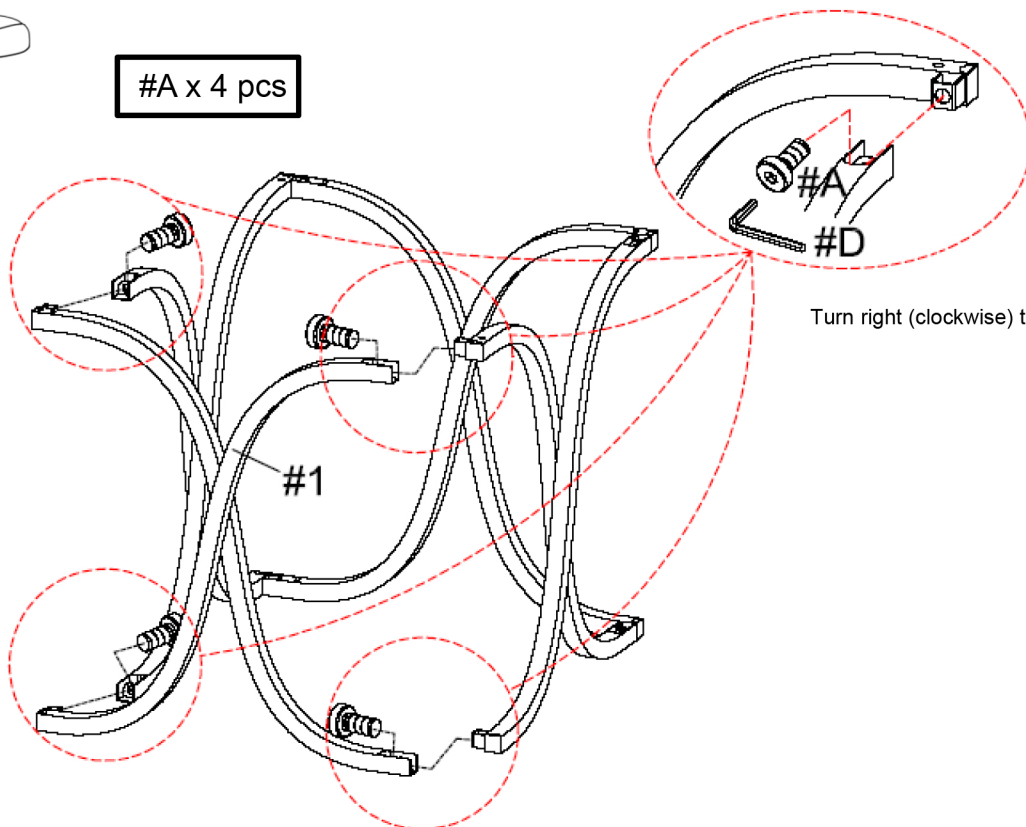

Turn right (clockwise) to tighten



Align the threaded ends of the 4 levelers (#B) with the pre-drilled holes on the leg stands (#1) and tighten by hand until secured.

#B x 4 pcs

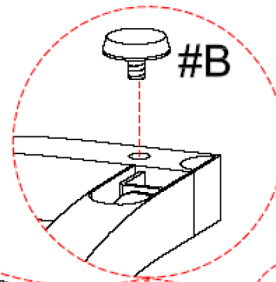

Turn right (clockwise) to tighten

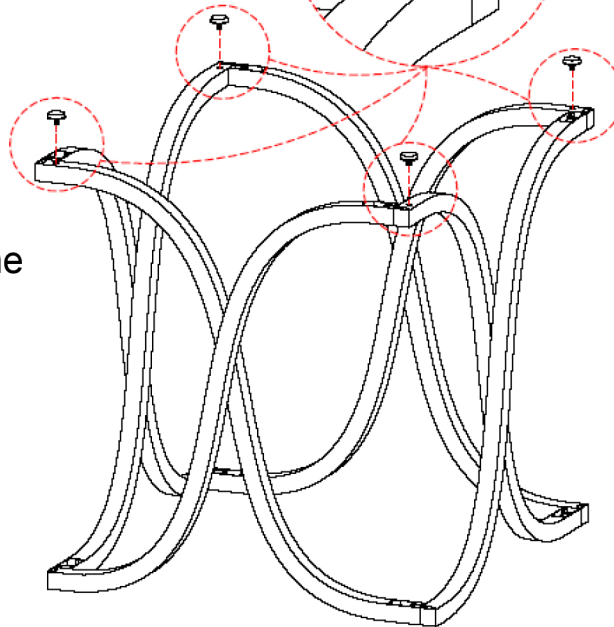

Adjust the levelers according to the ground level on Step 4.



#C x 4 pcs

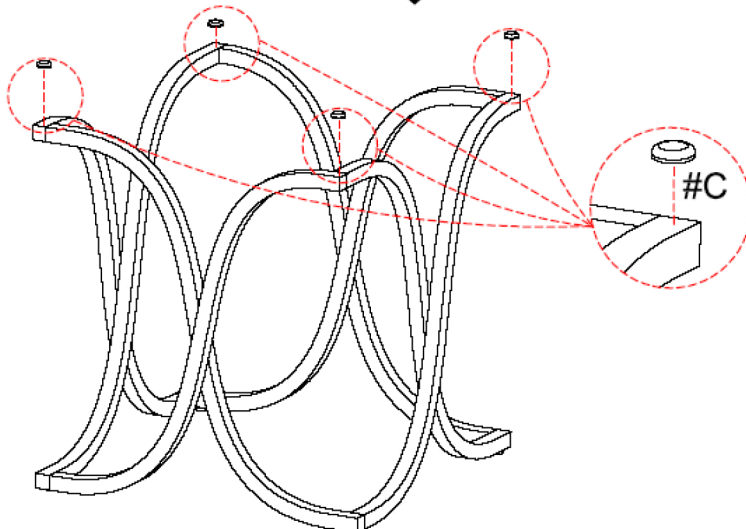

- I. Place 4 spacers (#C) on top of the leg stands (#1).
- II. With the help of another person, carefully place the glass top (#2) over the spacers (#C). The glass top (#2) should be evenly centered and flatly rested.
- III. Make sure the table is rested on a flat surface and does not feel loose or wobbly. If it does, double check that the bolts/screws are secured and properly tightened.
- IV. If necessary, adjust the levelers (#B) according to the ground level. To lower or to raise the levelers (#B), turn the levelers clockwise or counterclockwise, respectively.

ASSEMBLY IS COMPLETED