

# ASSEMBLY INSTRUCTIONS

Item NO. : DN210105

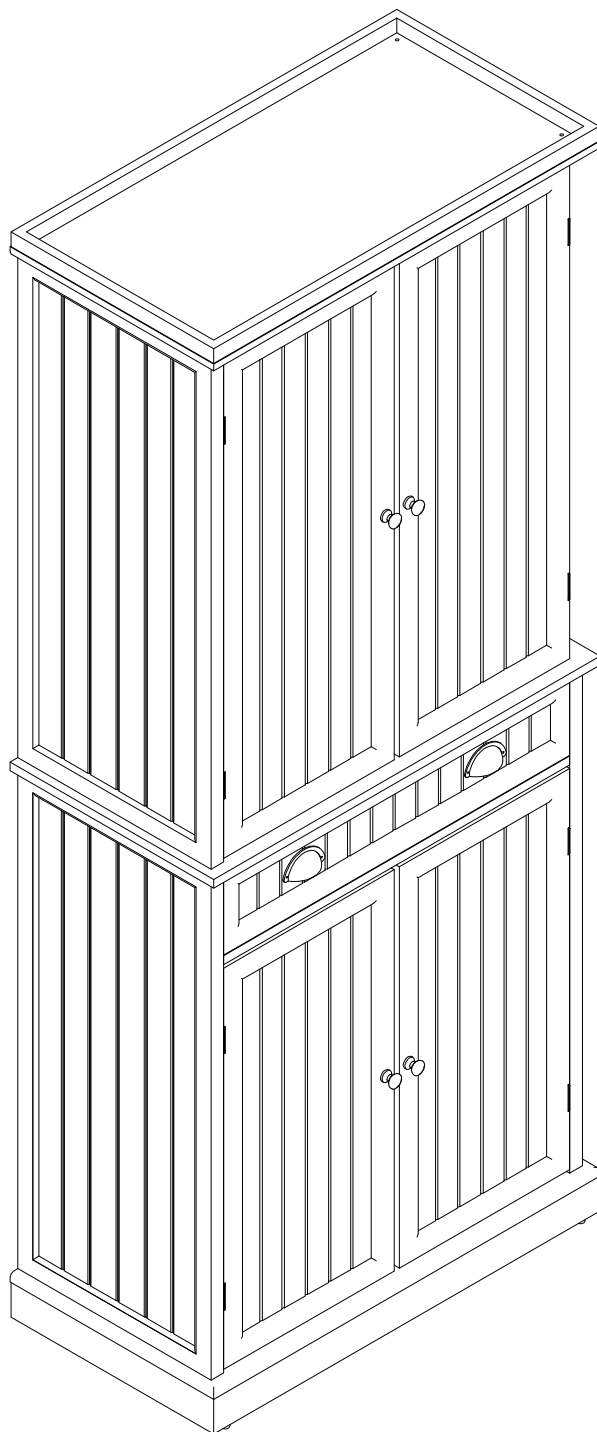

## ASSEMBLY TOOLS REQUIRED (NOT INCLUDED)

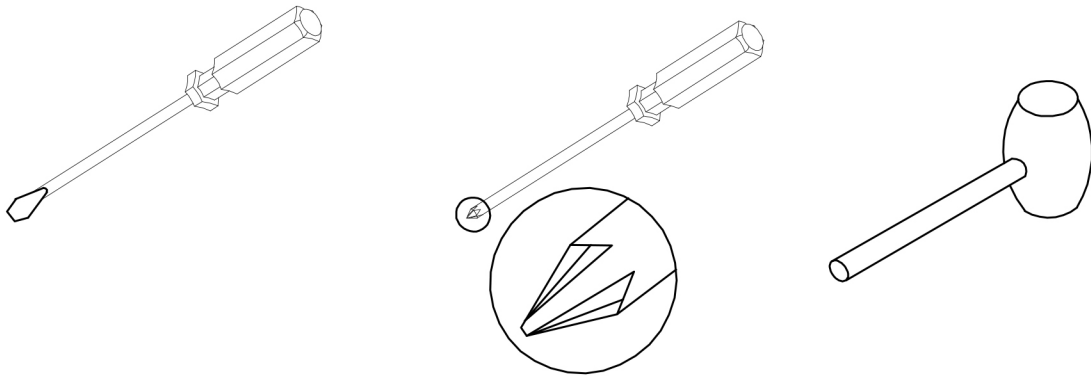

### Wooden dowel installation

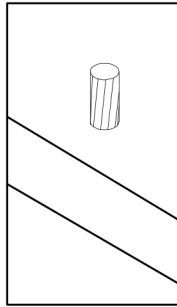
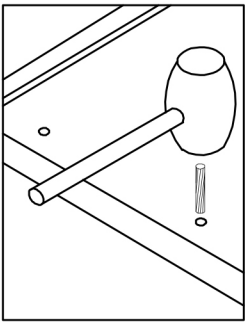

**Gently tap dowel into hole with rubber mallet.**

**\* Before discarding packing materials, please check all parts and hardware are presented.**







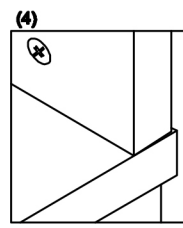
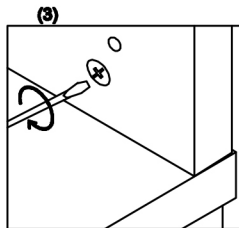
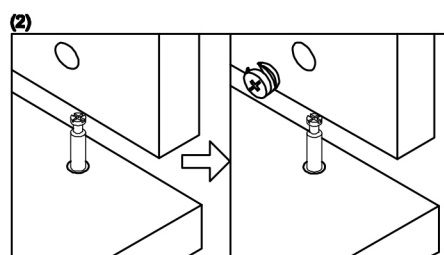
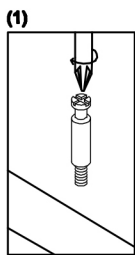

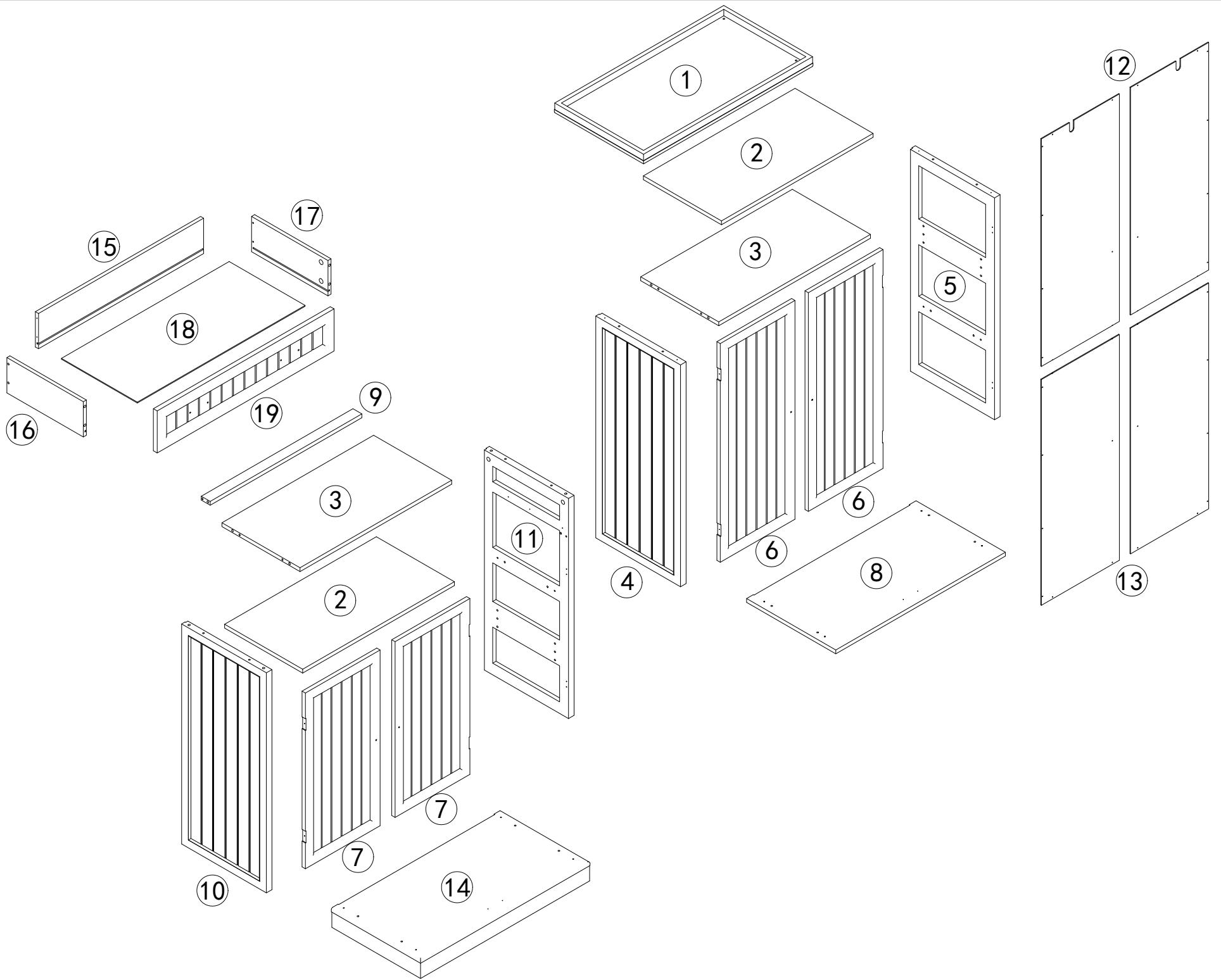
**\* Please follow the instructions closely.**

**\* After few days of initial assembly, the product may has acclimated to new environment, please tighten all hardware again.**

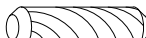
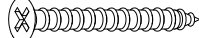
### Hidden connector..... Assembly Techniques

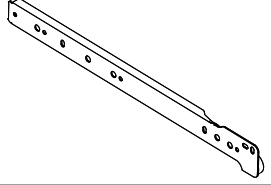
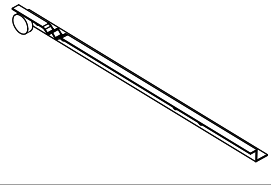
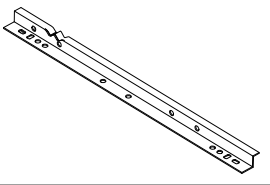
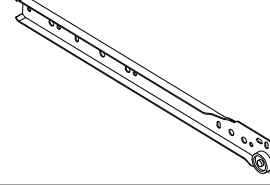
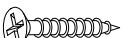
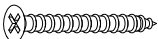
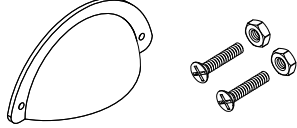
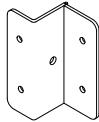

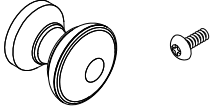
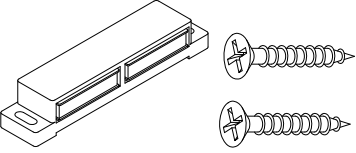

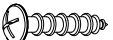
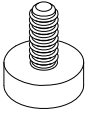
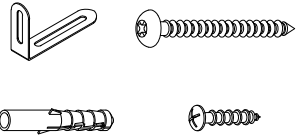
|   |  |  |  |   |
|---|--|--|--|---|
| <p><b>A</b>      ×18</p>  <p>φ6×35mm</p> | <p><b>B</b>      ×18</p>  <p>φ10×15mm</p> | <p><b>C</b>      ×18</p>  <p>φ6×30mm</p>  | <p><b>D</b>      ×12</p>  <p>FA4×45mm</p> | <p><b>E</b>      ×8</p>  <p>6×10+13×19mm</p> |
| <p><b>F</b>      ×1</p>  <p>300mm</p>    | <p><b>G</b>      ×1</p>  <p>300mm</p>     | <p><b>H</b>      ×1</p>  <p>300mm</p>      | <p><b>I</b>      ×1</p>  <p>300mm</p>     | <p><b>J</b>      ×60</p>  <p>FA3×12mm</p>    |
| <p><b>K</b>      ×4</p>  <p>FA4×30mm</p> | <p><b>L</b>      ×2</p>  <p>M4×10mm</p>   | <p><b>M</b>      ×8</p>                   | <p><b>N</b>      ×8</p>                   | <p><b>O</b>      ×4</p>                      |
| <p><b>P</b>      ×4</p>  <p>FA3×14mm</p> | <p><b>Q</b>      ×4</p>  <p>φ8×40mm</p>   | <p><b>R</b>      ×32</p>  <p>FA3×12mm</p> | <p><b>S</b>      ×4</p>                   | <p><b>T</b>      ×2</p>                      |

1

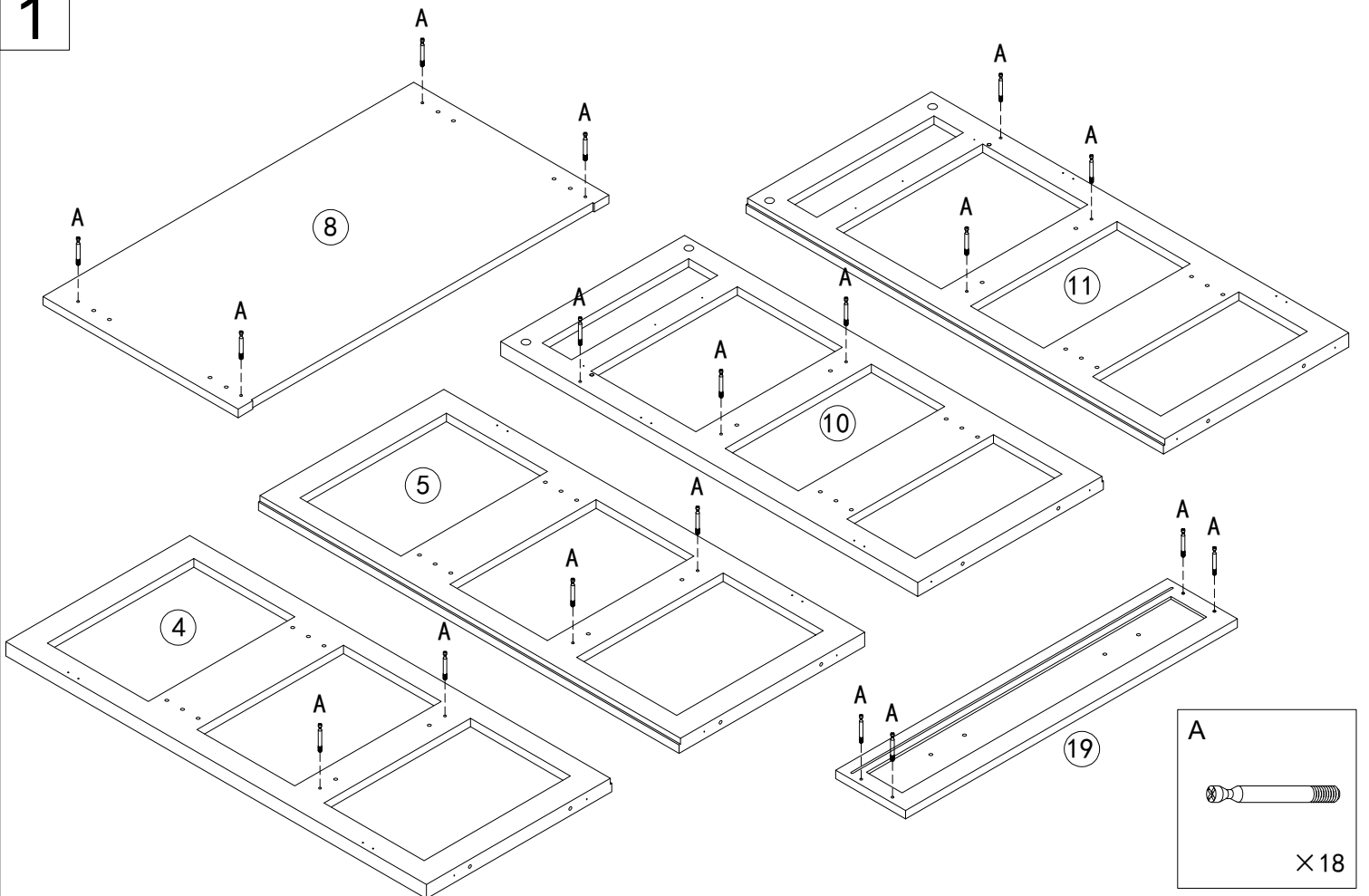

2

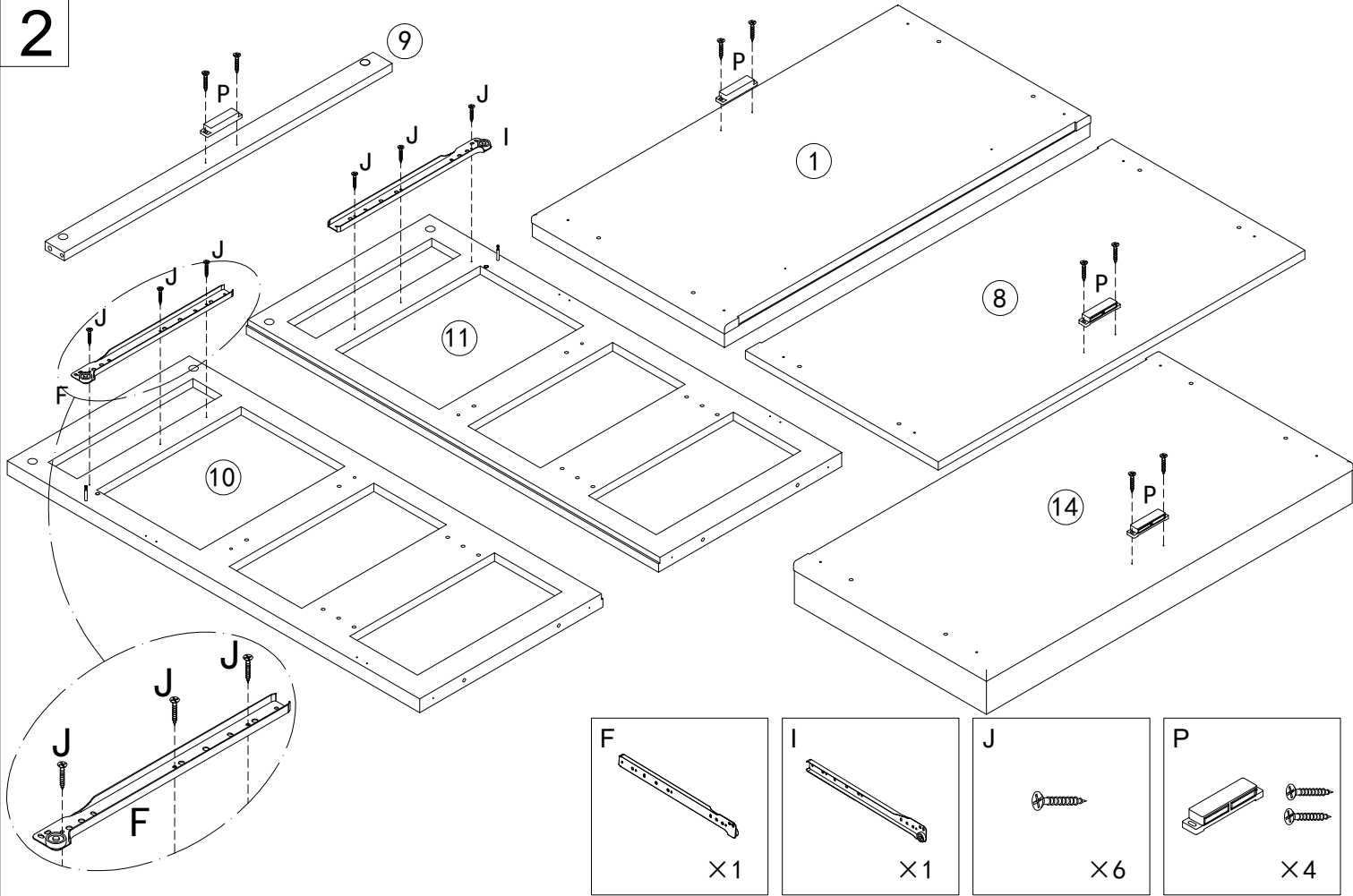

3

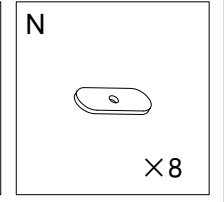
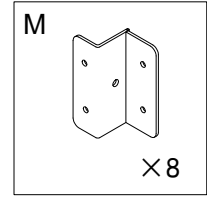
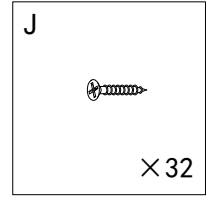
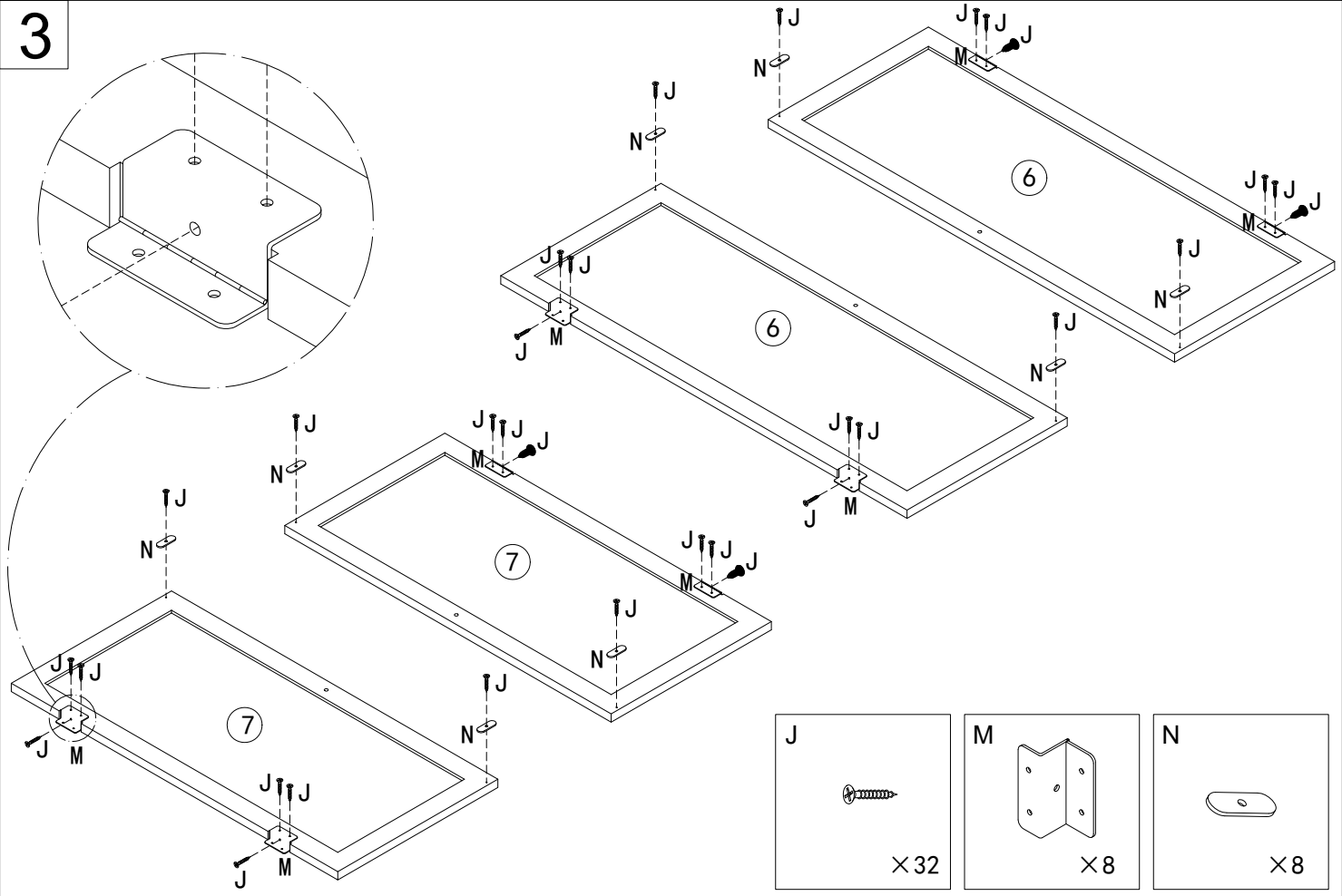

4

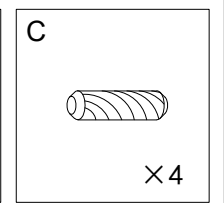
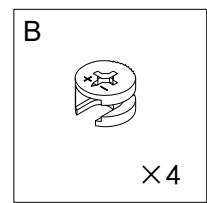
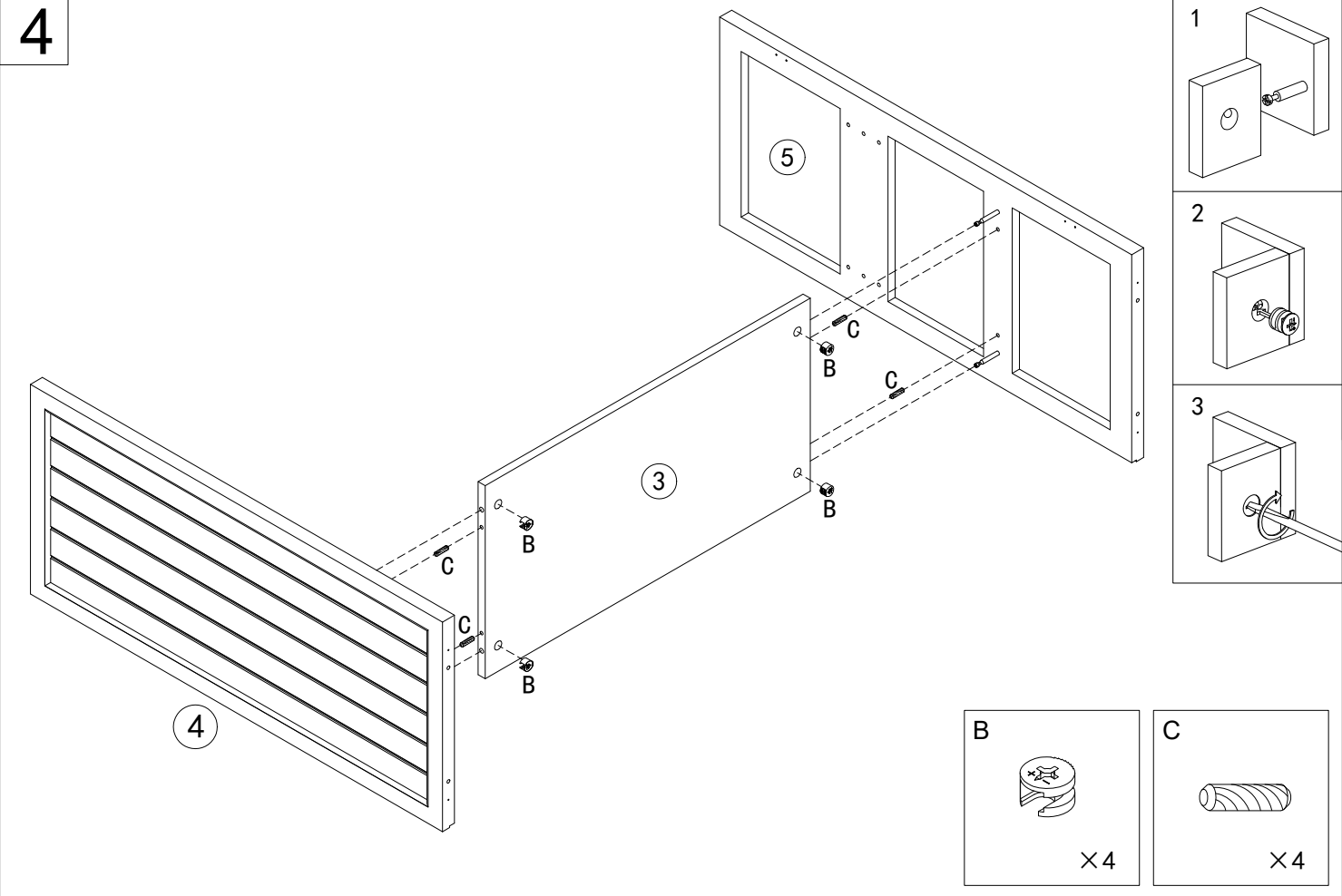

5

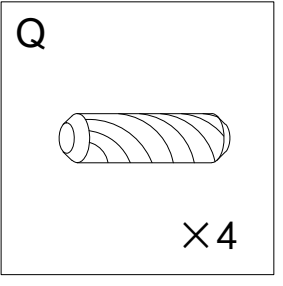
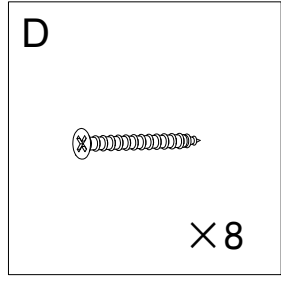
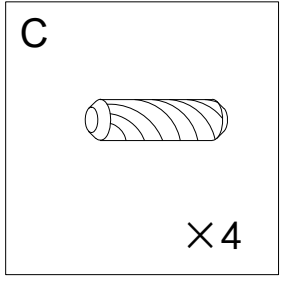
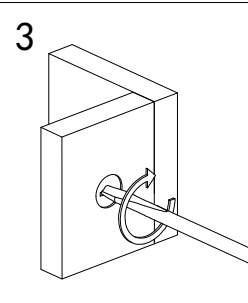
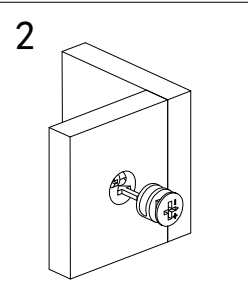
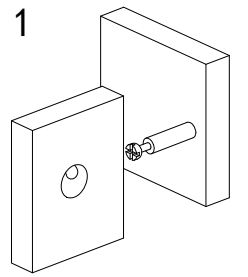
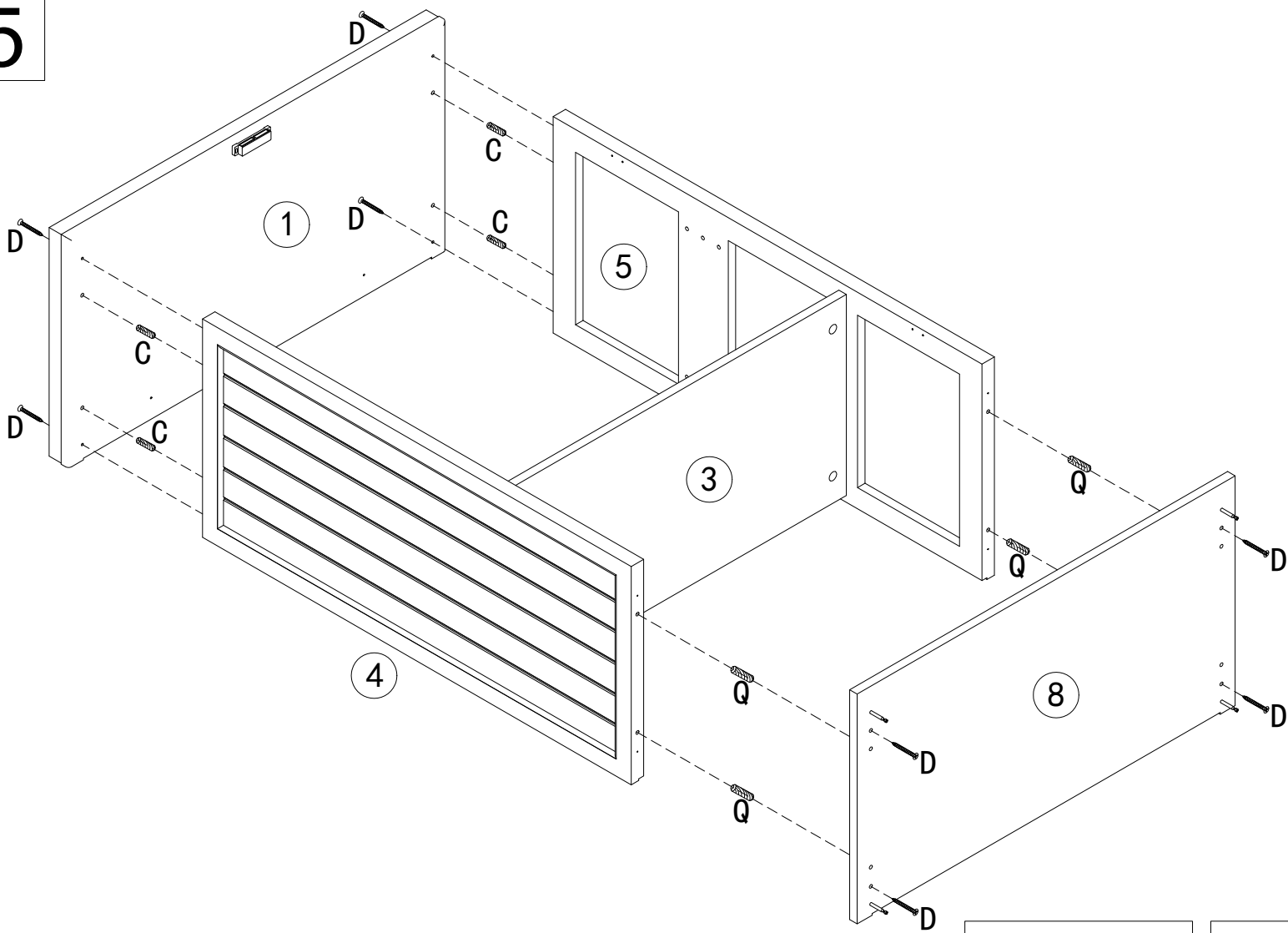

6

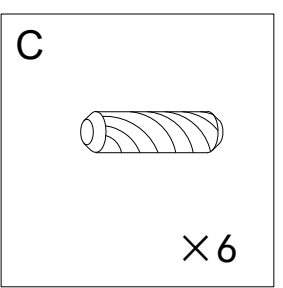
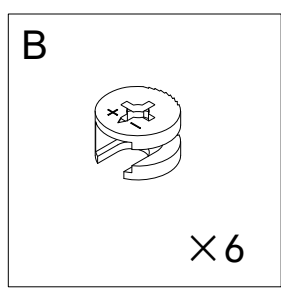
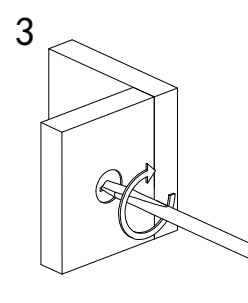
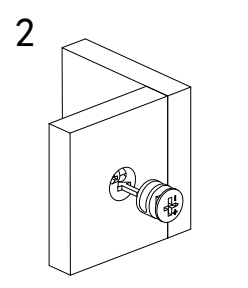
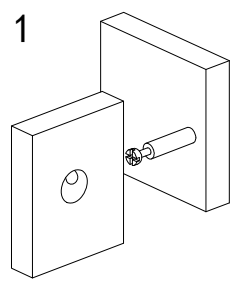
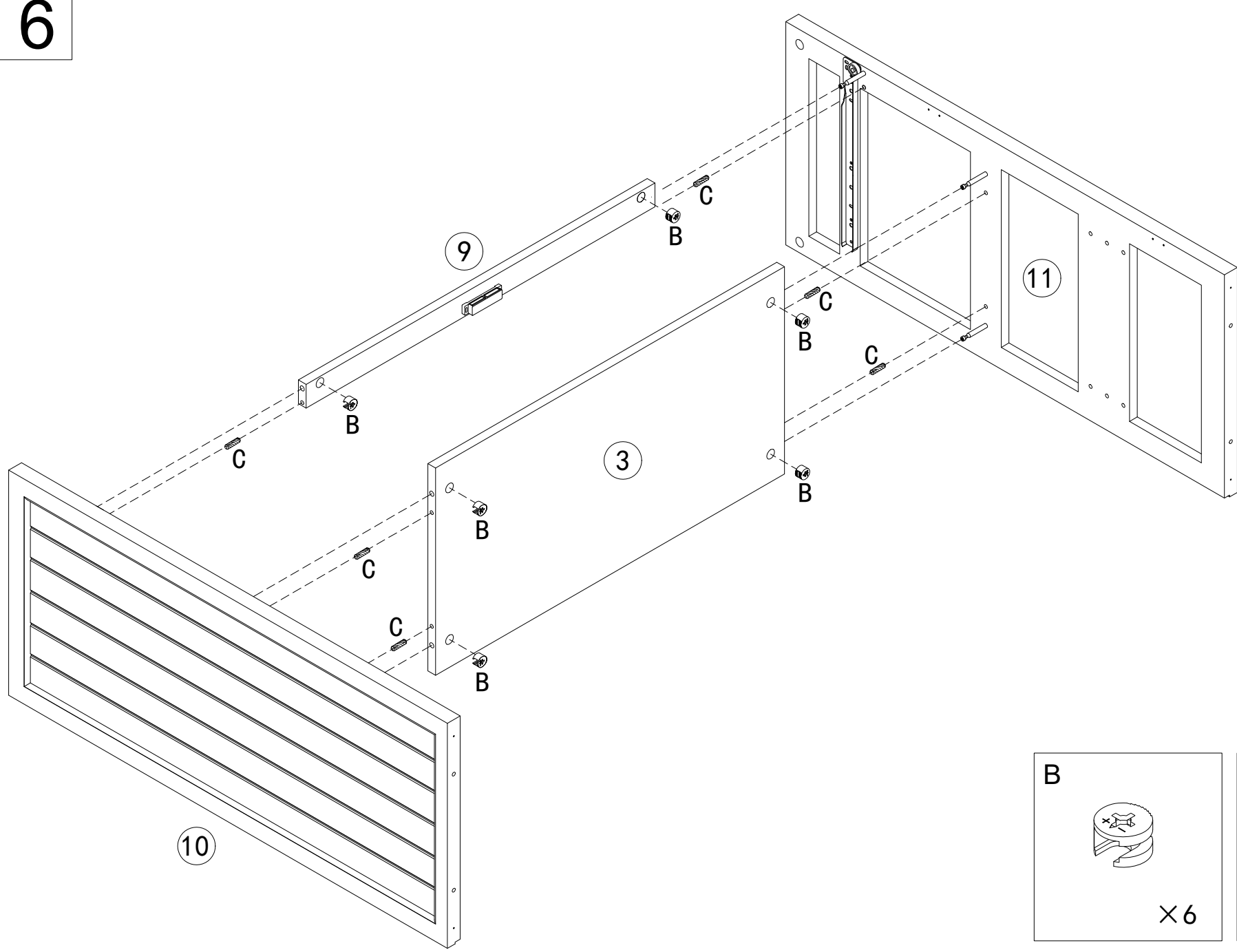

7

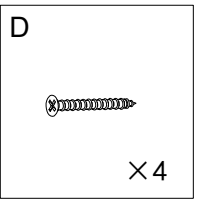
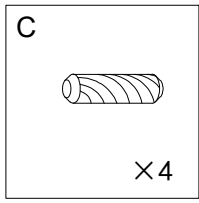
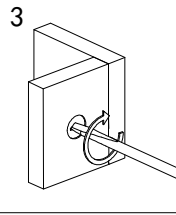
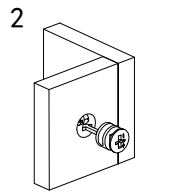
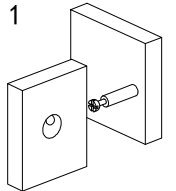
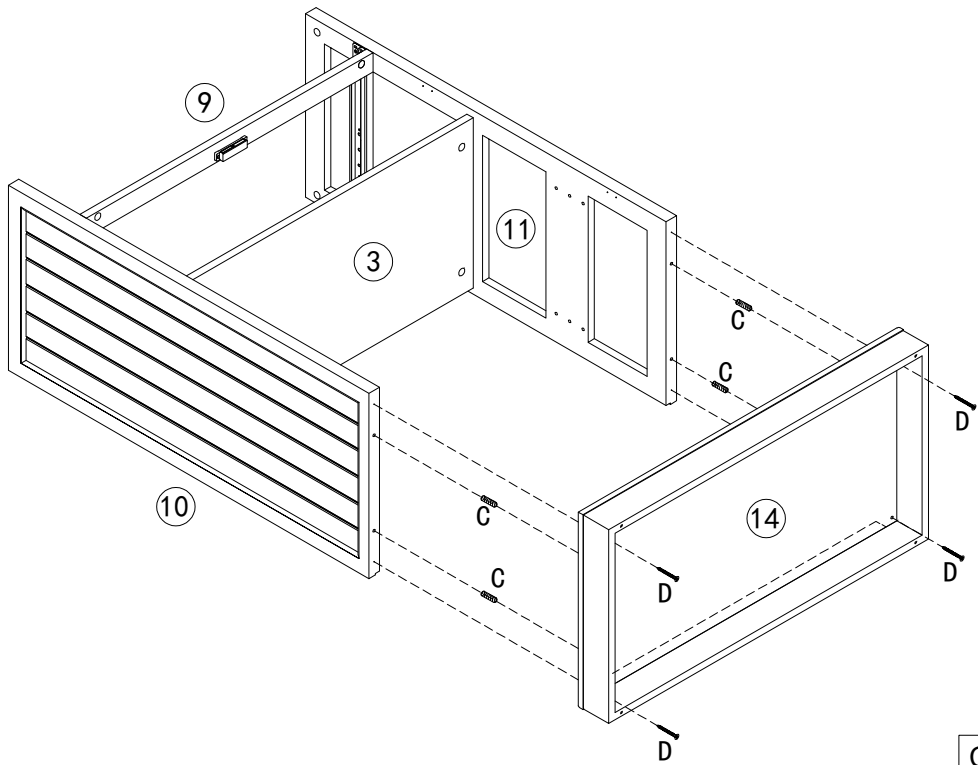

8

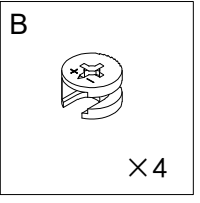
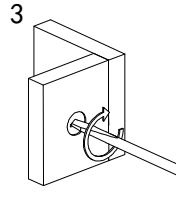
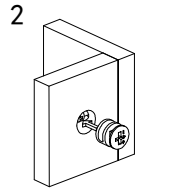
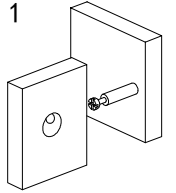
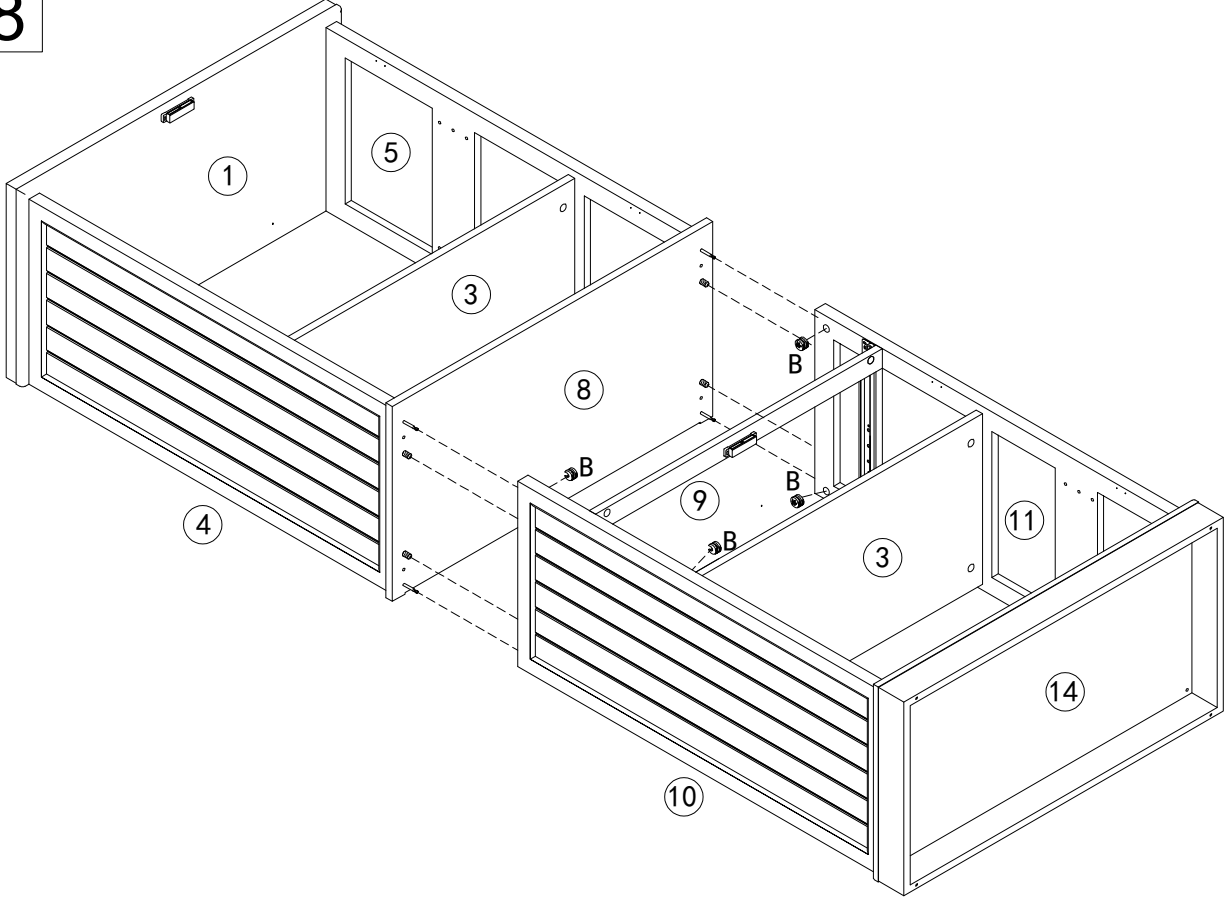

9

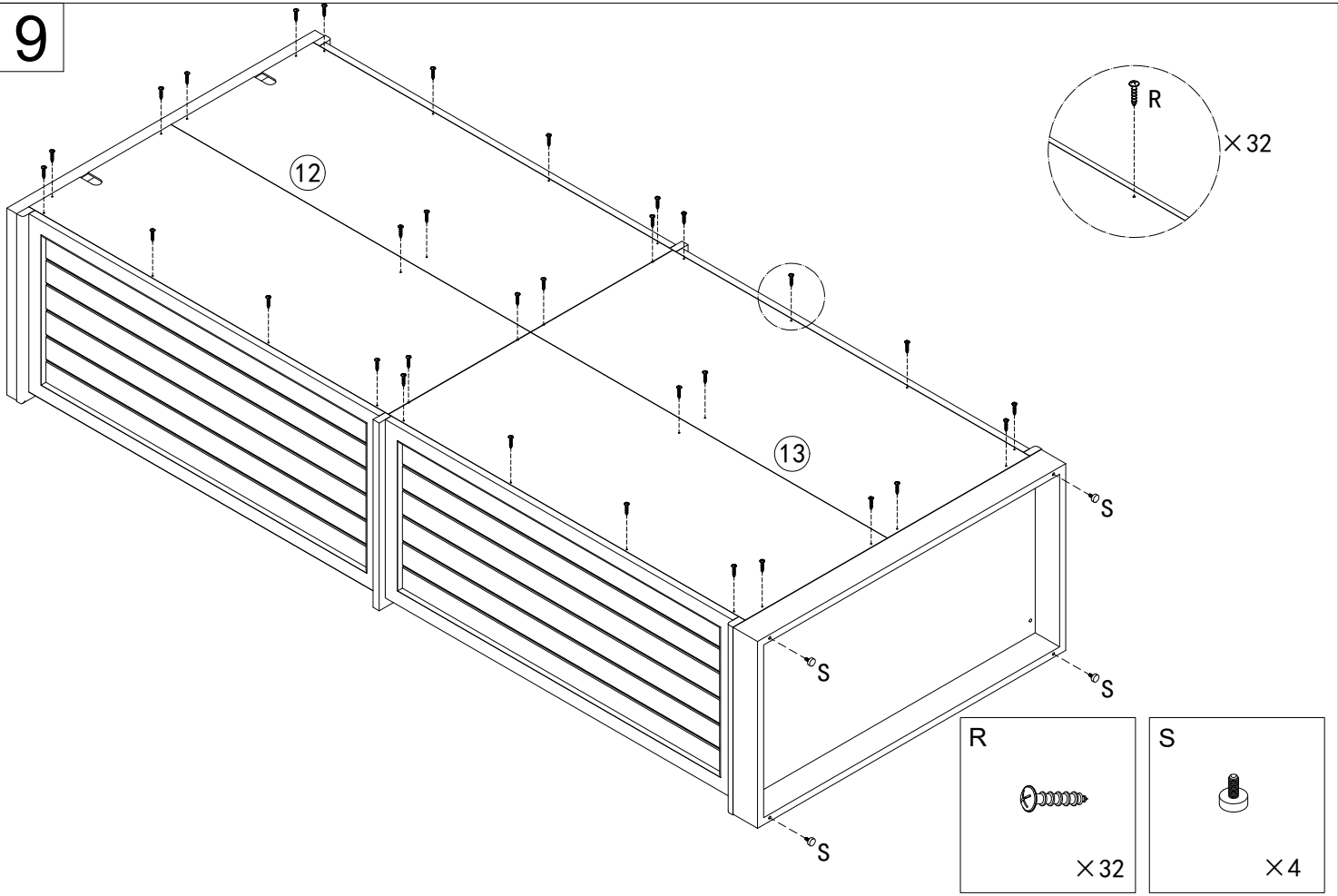

10

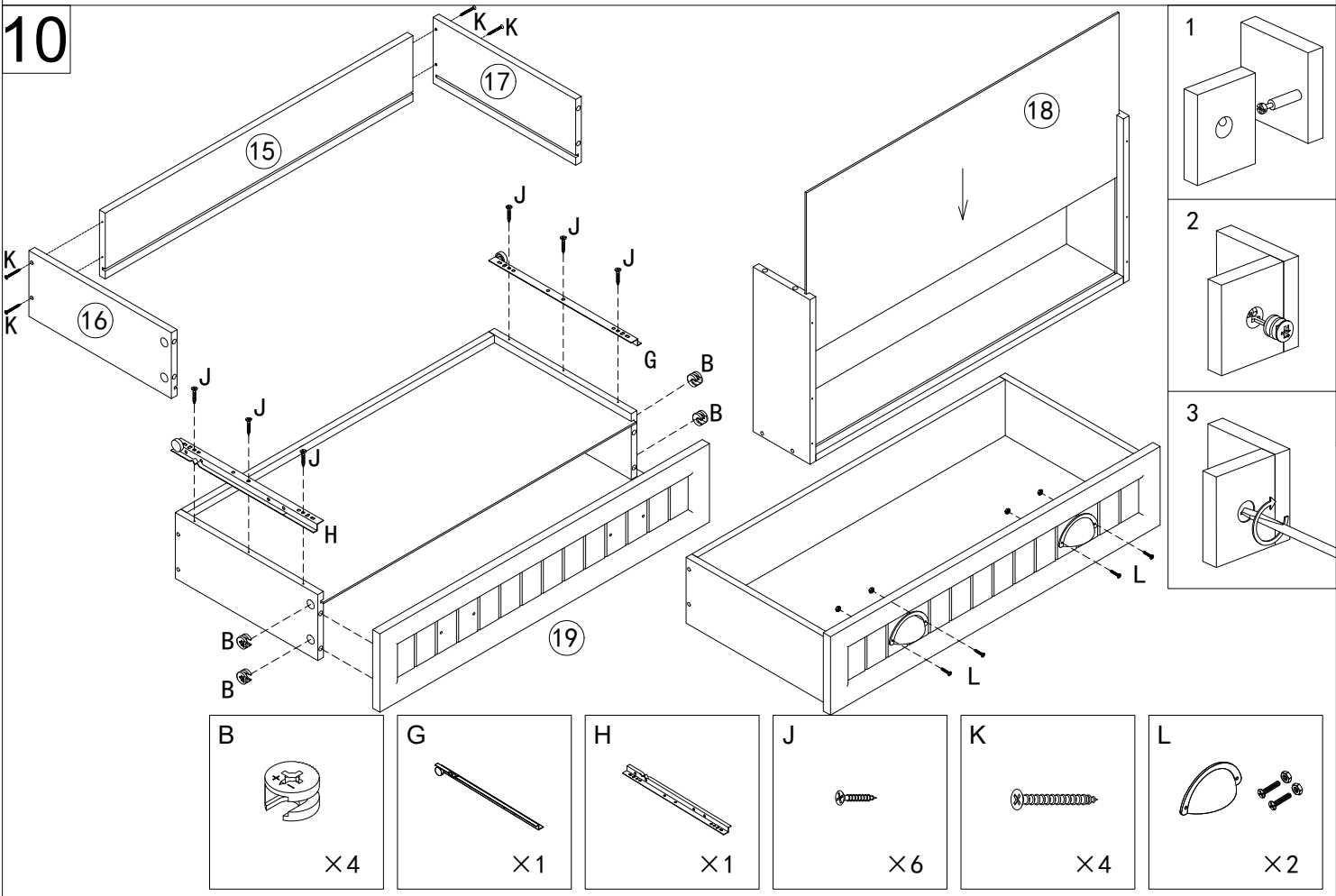

11

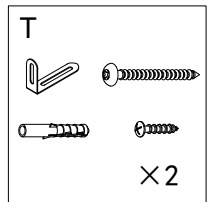
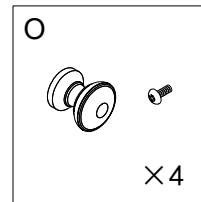
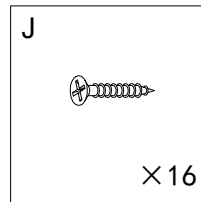
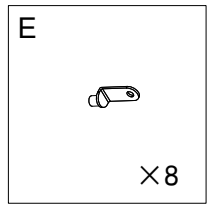
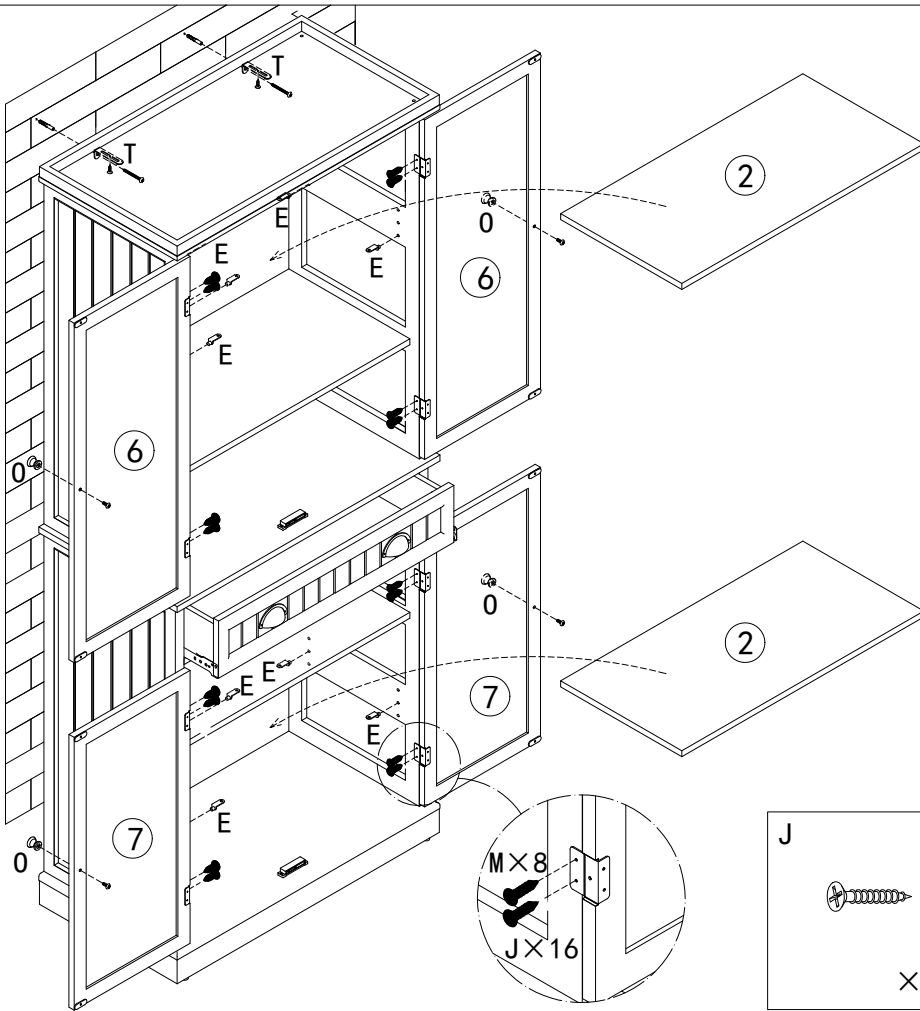

12

