

## CARE AND MAINTENANCE

Store outdoor furniture indoors or cover well when not in use.  
Remove wooden furniture from standing water. Dust regularly with small brush or vacuum  
Spills should be taken care of immediately before they harden or stain with a slightly dampened sponge.



















## NOTICE

- \* Please make sure that you have all parts indicated before you begin assembly of this item
- \* This item should be assembled on a soft surface to prevent scratching the finish during assembly
- \* This item may require periodic tightening

**Weight Capacity : 275 Lbs (single seat)  
550 Lbs (towperson seat)**  
**Warning : Do not stand on chair**  
**Warning : Do not over torque bolts/screws**



## Part List and Hardware List

PIECE	DESCRIPTION	PICTURE	QUANTITY
1	Chair/Bench left frame		3X
2	Chair/Bench right frame		3X
3	Bench back frame		1X
4	Chair back frame		2X
5	Bench seat frame		1X
6	Bench front frame		1X
7	Chair seat chair		2X
8	Chair front frame		2X
9	Bench seat cushion		1X
10	Chair seat cushion		2X
11	Chair/Bench back cushion		4X
12	Leg table		2X
13	Table bottom frame		1X
14	Table glass		1X
A	Allen bolt(M6x30 mm)		17X
B	Allen bolt(M6x40 mm)		28X
C	Allen bolt(M6x60 mm)		6X
D	Flat washer		51X
E	Allen key		3X

Product Dimensions:

48.82"x26.38"x29.92" H (Bench)

25.98"x26.38"x29.92" H (Chair)

36.22"x22.04"x17.12" H (Table)

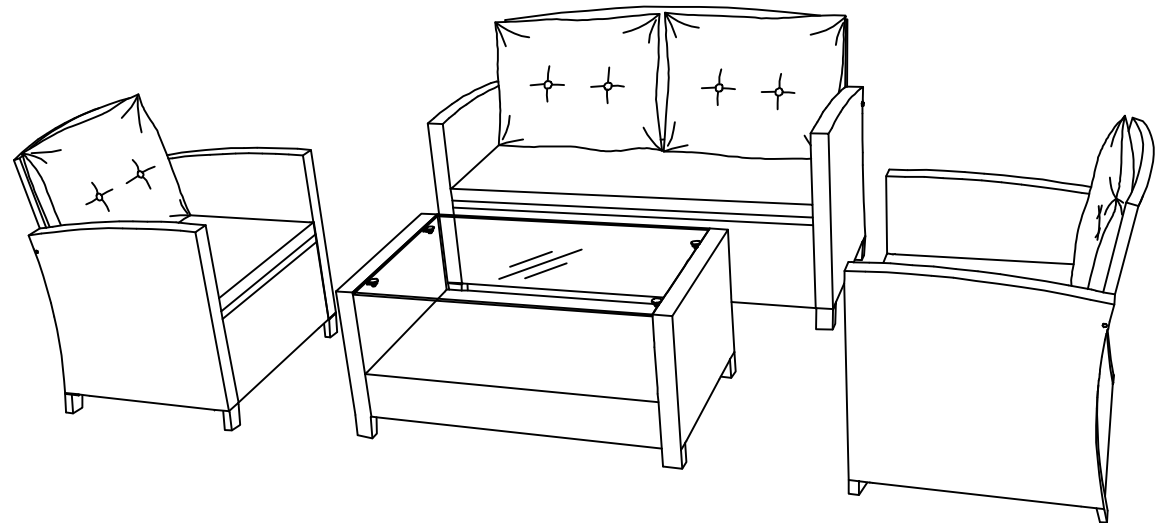

## CARE AND MAINTENANCE

Store outdoor furniture indoors or cover well when not in use.  
Remove wooden furniture from standing water. Dust regularly with small brush or vacuum  
Spills should be taken care of immediately before they harden or stain with a slightly dampened sponge.

## NOTICE

- \* Please make sure that you have all parts indicated before you begin assembly of this item
- \* This item should be assembled on a soft surface to prevent scratching the finish during assembly
- \* This item may require periodic tightening

**Weight Capacity : 275 Lbs (single seat)  
550 Lbs (towperson seat)**

**Warning : Do not stand on chair**

**Warning : Do not over torque bolts/screws**



## Part List and Hardware List

PIECE	DESCRIPTION	PICTURE	QUANTITY
1	Chair/Bench left frame		2X
2	Chair/Bench right frame		2X
4	Chair back frame		2X
7	Chair seat frame		2X
8	Chair front frame		2X
10	Chair seat cushion		2X
11	Chair/Bench back cushion		2X
A	Allen bolt(M6x30 mm)		8X
B	Allen bolt(M6x40 mm)		14X
C	Allen bolt(M6x60 mm)		4X
D	Flat washer		26X
E	Allen key		1X

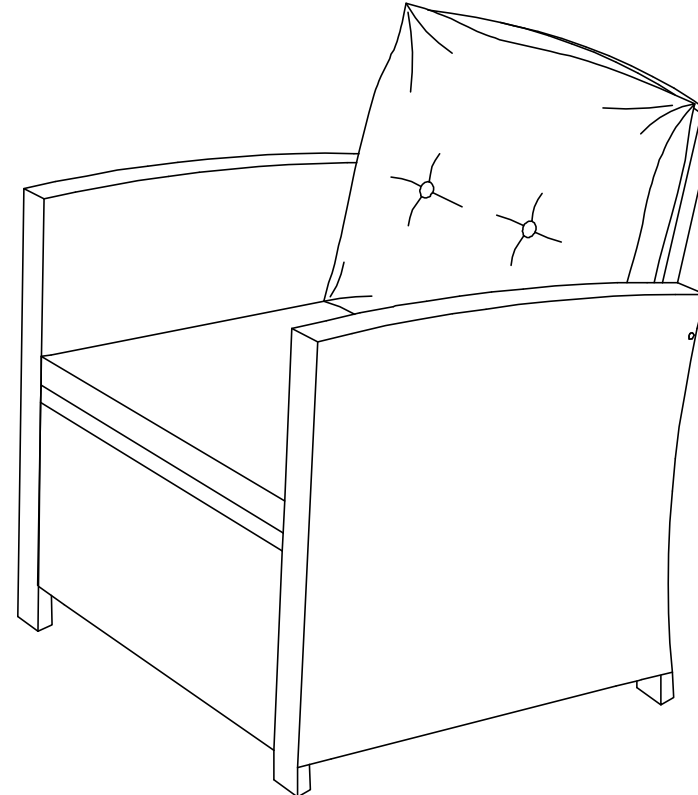

1 x2

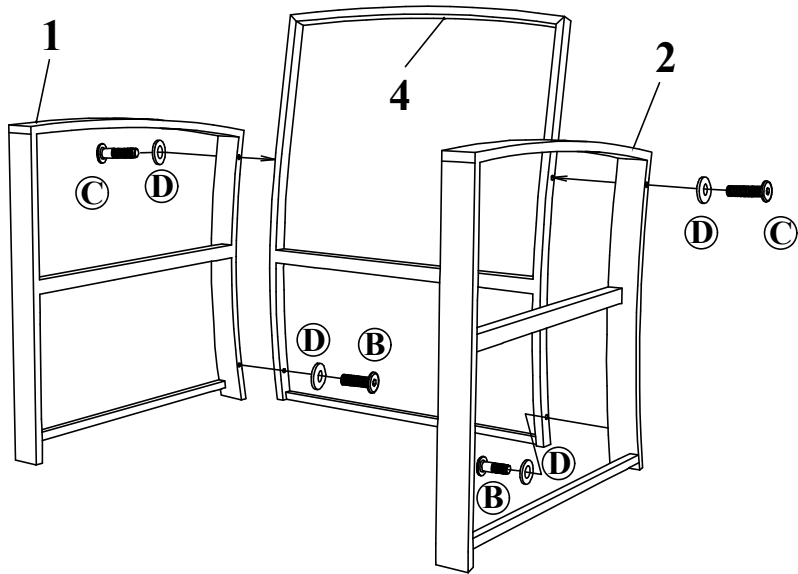

Step 1  
 Connect Chair Left Frame (1) & Chair Back Frame (4) & Chair Right Frame (2) & tighten Bolt (B),(C) with Allen key (E)

2 x2

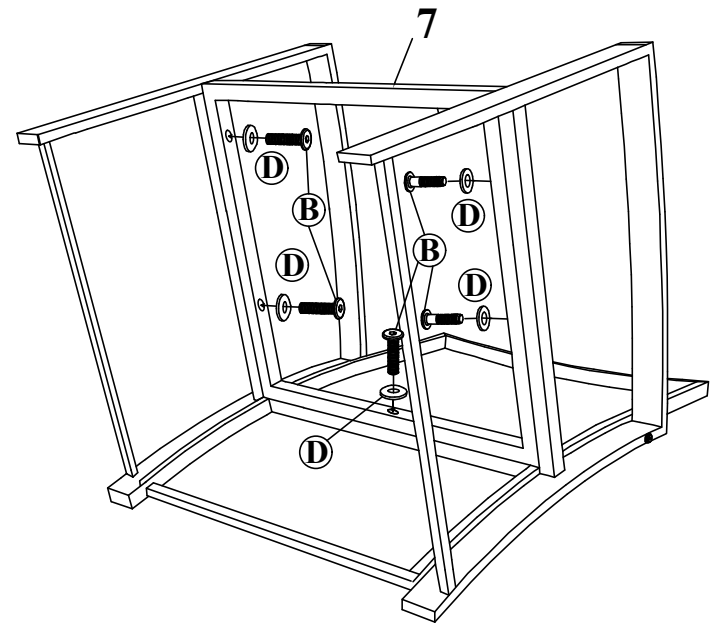

Step 2  
 Connect part from Step 1 & Chair Seat Frame (7) tighten Bolt (B) with Allen key (E)

3 x2

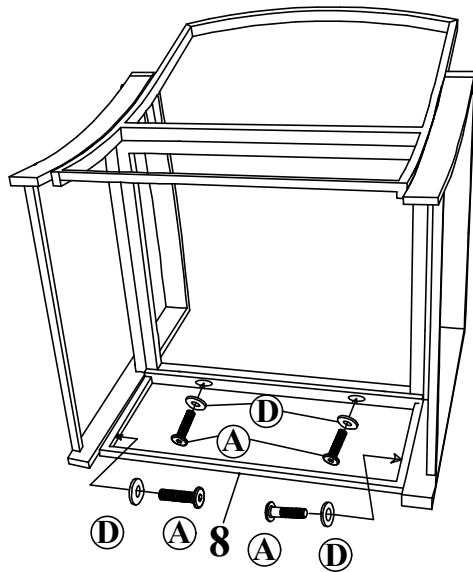

Step 3  
 Connect part from Step 2 & Chair Front Frame (8) tighten Bolt (A) with Allen key (E)

4 x2

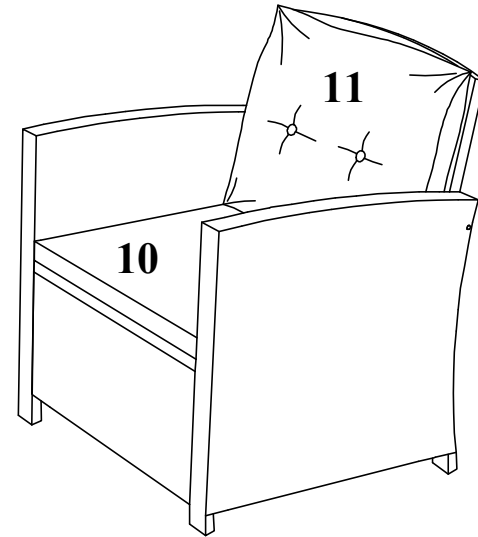

Step 4  
 Put on Chair Seat Cushion (10) & Chair Back Cushion (11) to complete Chair