

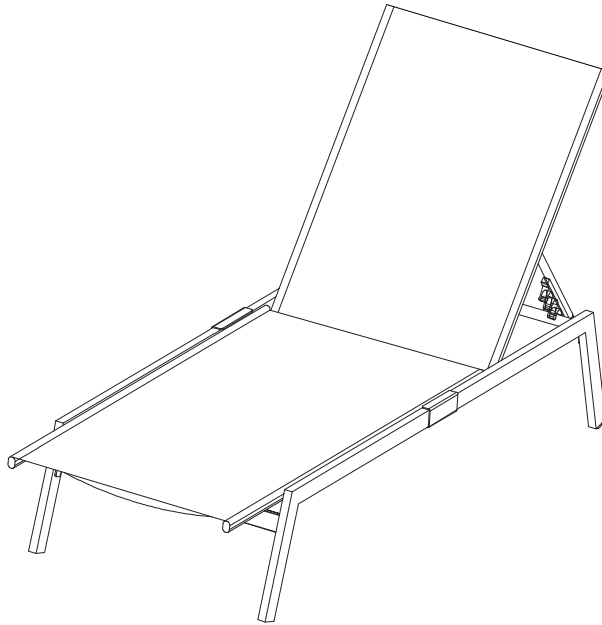





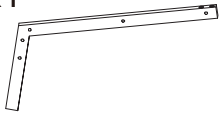
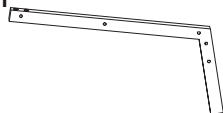
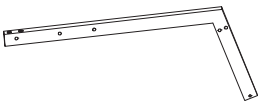
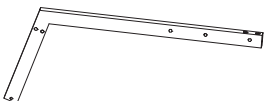
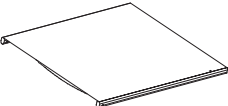
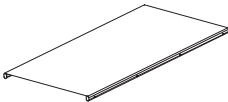
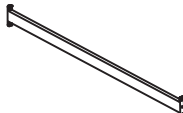
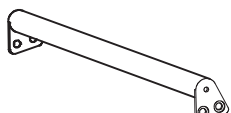
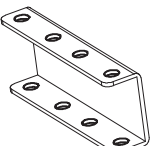

# ASSEMBLY INSTRUCTIONS

## Lounge chair





Thanks for choosing our product. Please kindly check parts listed below and read this manual carefully, then assemble them step by step. Please feel free to contact us for any questions.



### Parts List



<b>A</b> X1  Right Front Leg	<b>B</b> X1  Left Front Leg	<b>C</b> X1  Right Back Leg	<b>D</b> X1  Left Back Leg
<b>E</b> X1  Seat	<b>F</b> X1  Backrest	<b>G</b> X1  Front Connection	<b>H</b> X1  Back Connection Bar
<b>I</b> X2  Metal Clip	<b>J</b> X36  Washer M6	<b>K</b> X8  Bolt M6×20mm	<b>L</b> X12  Bolt M6×35mm
<b>M</b> X8  Bolt M6×55mm	<b>N</b> X8  Nut	<b>O</b> X28  Acorn Nut	<b>P</b> X1  Allen Key <b>Q</b> X1  Wrench

STEP1

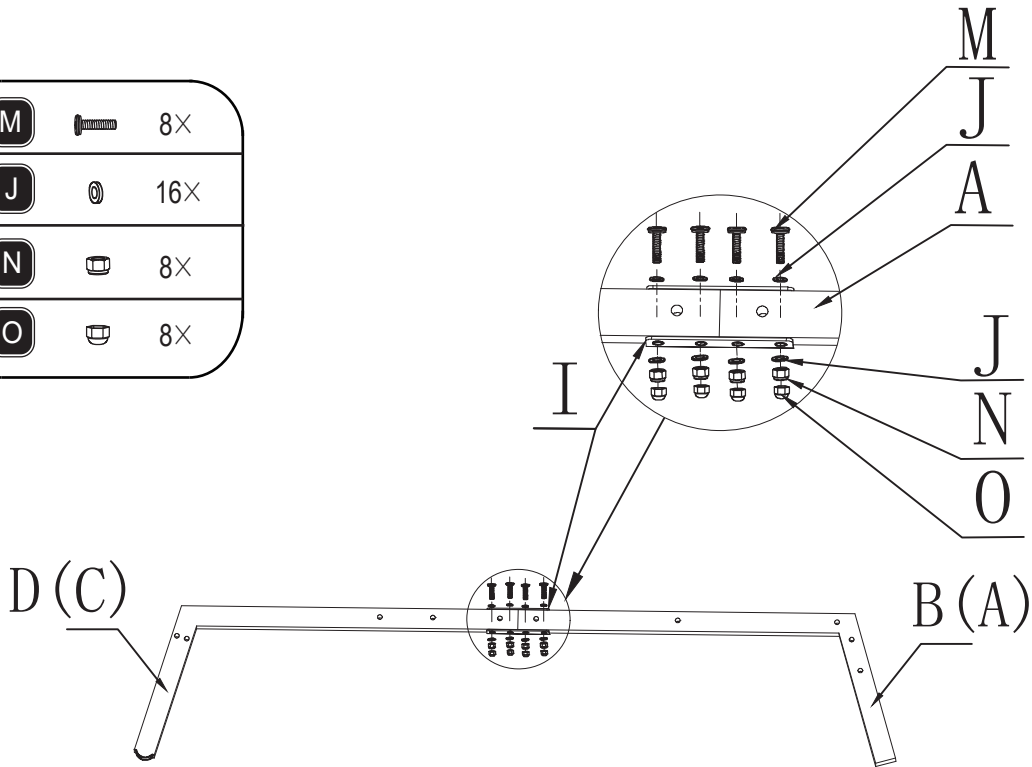
M		8X
J		16X
N		8X
O		8X



STEP2

J		6X
L		6X
O		6X

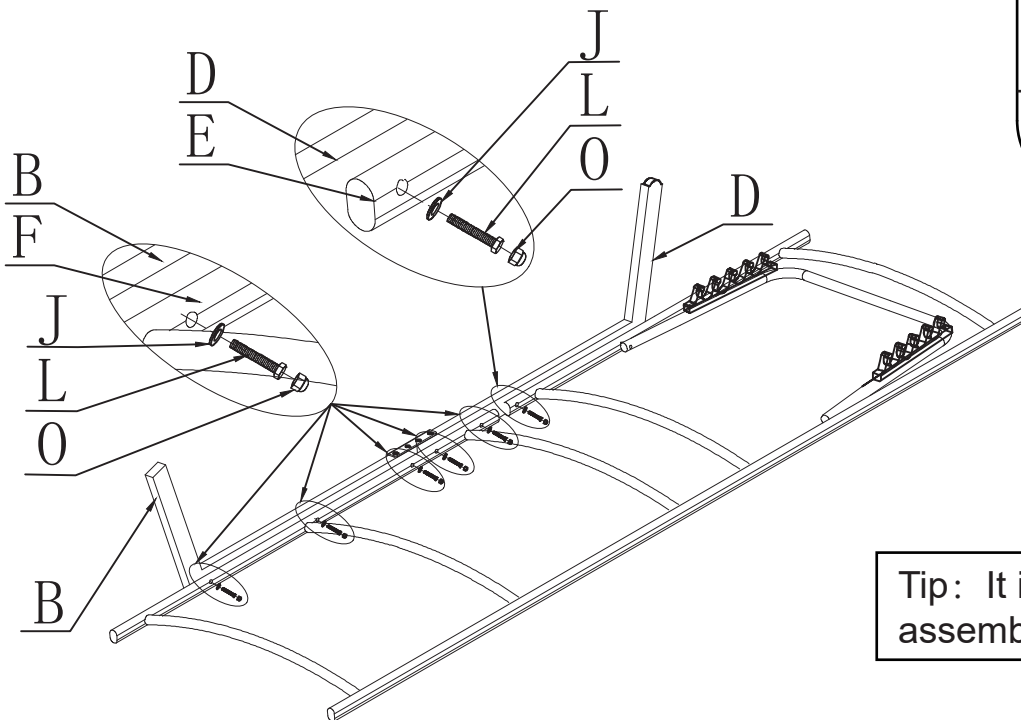

Tip: It is better that assemble side by side.

## Assembly Instruction

### STEP3

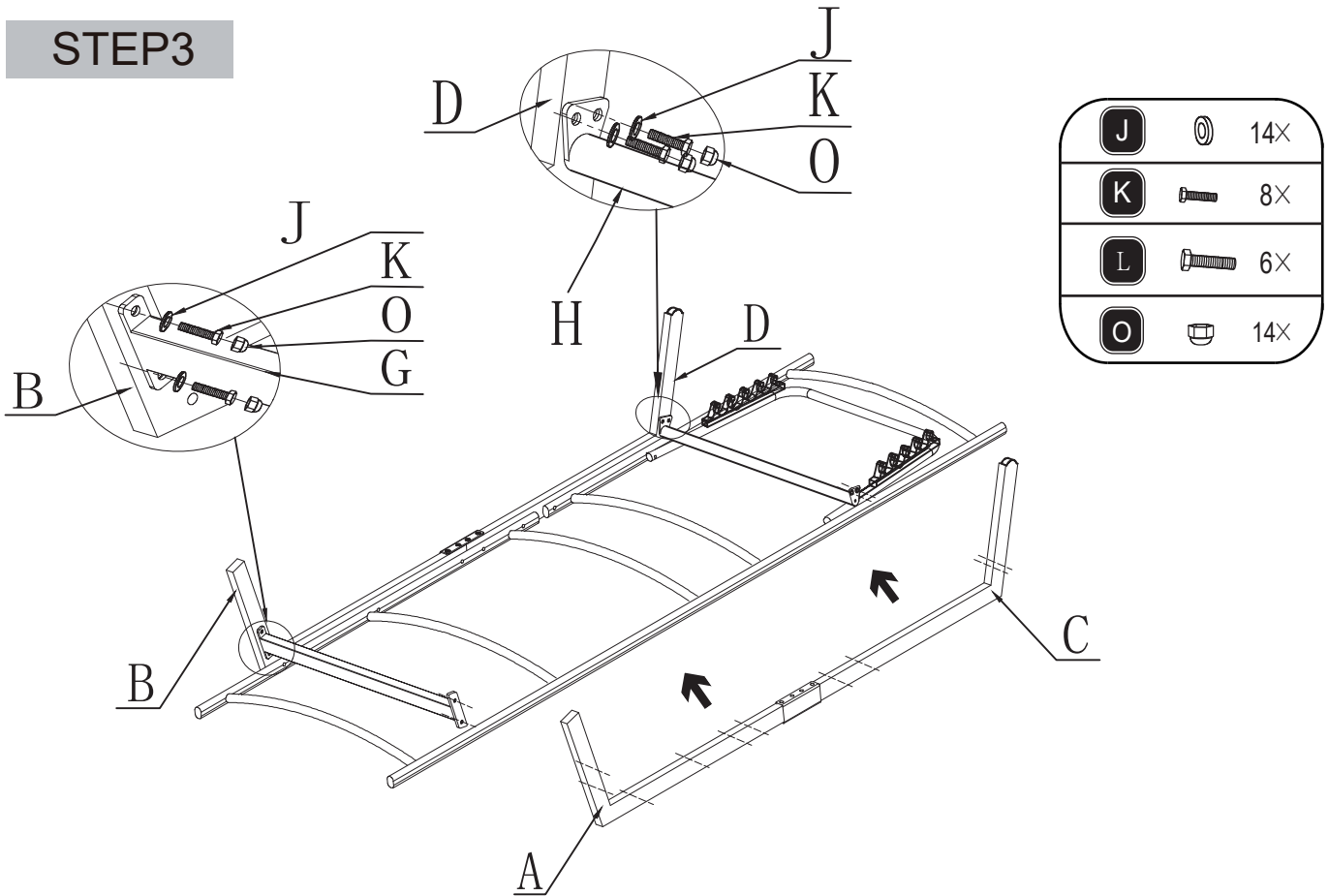

### STEP4

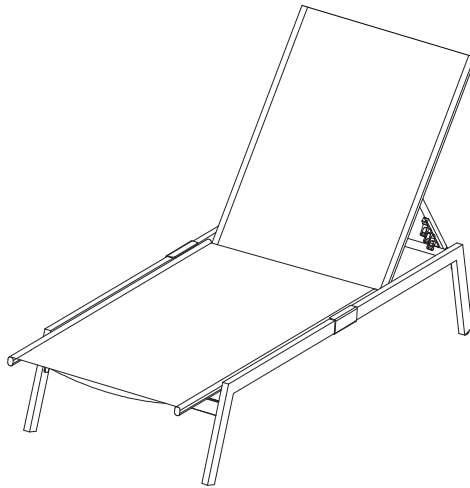

**FINISH!**

### Attention

1. We care about every customer's using experience, please feel free to chat us if has anything missing or damaged or any advice, efficient solution would be offered soon.
2. Recommend to use waterproof furniture cover for entire patio lounge chair when out of use to keep them longer performance.
3. Please keep your children away when you assembly. This item contains small parts which can be swallowed by children.