

# Assembly Guide

PXXZOT108

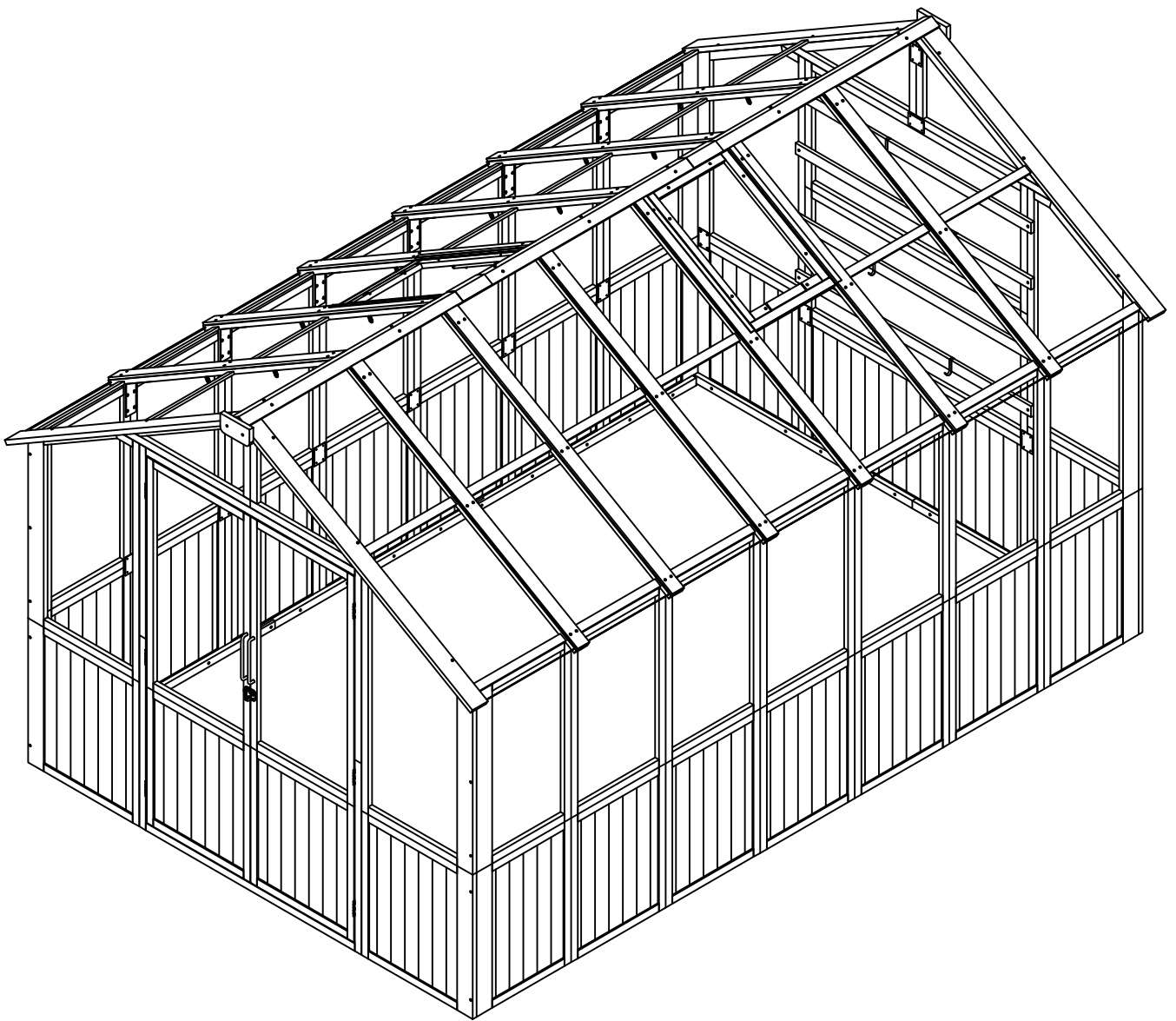

READ AND SAVE THIS INSTRUCTIONS FOR FUTURE USE

**ASSEMBLY & INSTRUCTION MANUAL**

Hx4

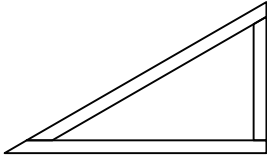

Lx6

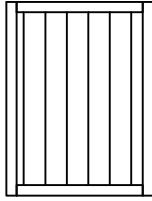

Sx6

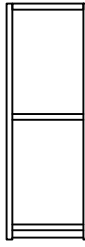

V1x2



V2x2

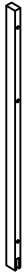

W1x1



W2x1



X1x2

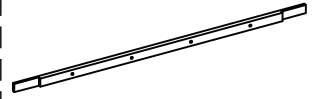

X2x4

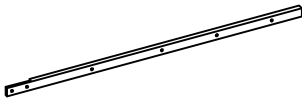

X3x4

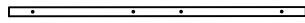

Y2x2



Zx2

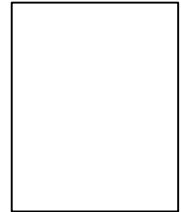

X4x4

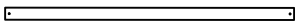

Y3x1



E1x1

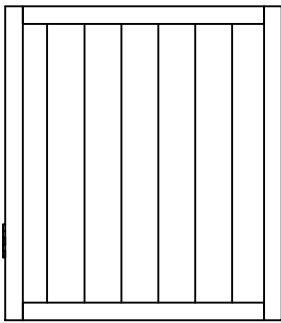

E2x1

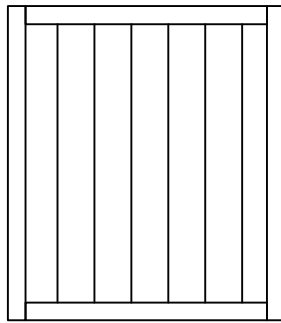

Qx2

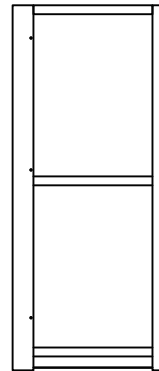

Rx2

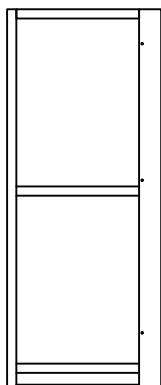

Sx2

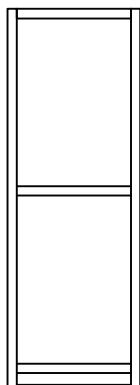

Tx2

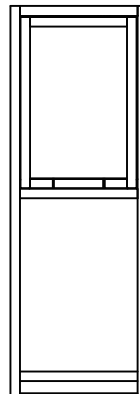

Y1x12



A1x1

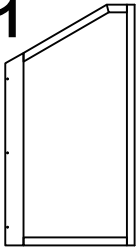

A2x1

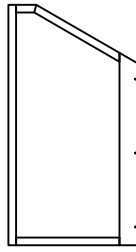

B1x1

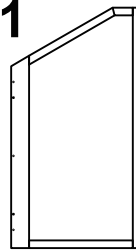

B2x1

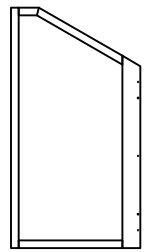

C1x2

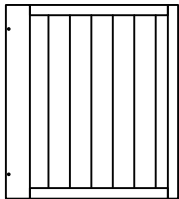

C2x2

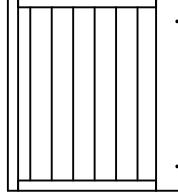

D1x1

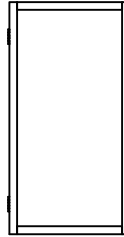

D2x1

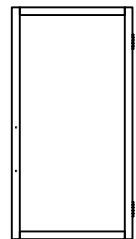

Fx2

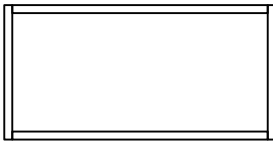

Gx1

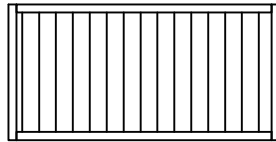

Mx2

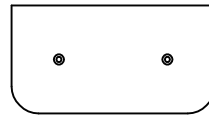

Nx2

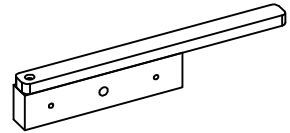

Ox1

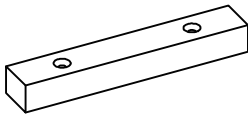

Px1

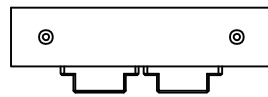

Ux18

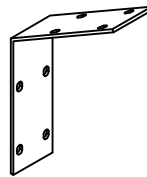

I1x2

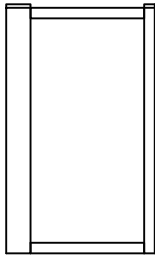

I2x2



Jx10

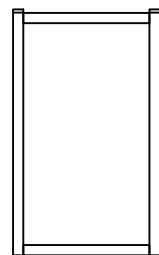

K1x1

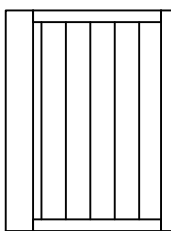



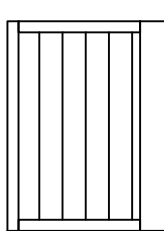



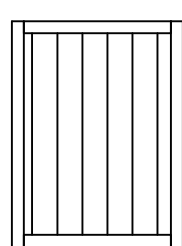

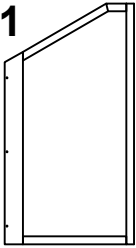
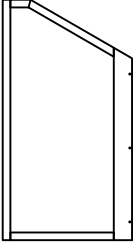
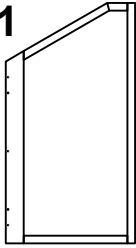
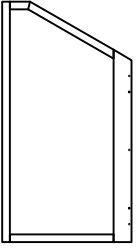
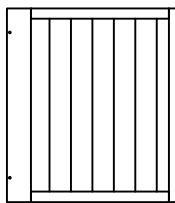
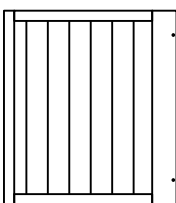
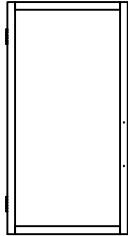
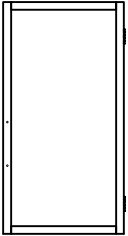
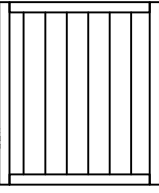
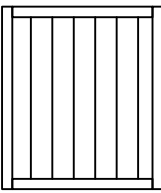
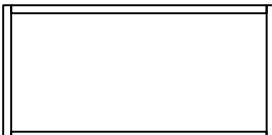
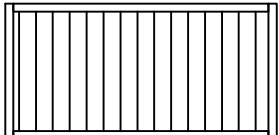
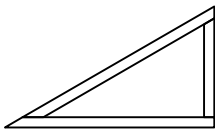
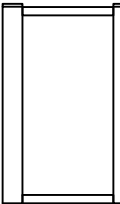
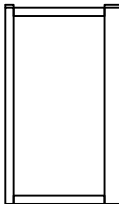
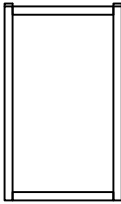
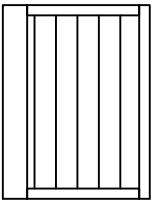
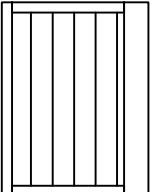
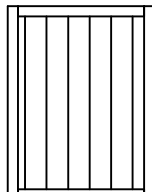
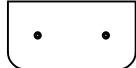
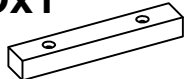
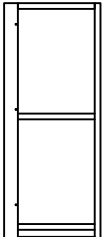
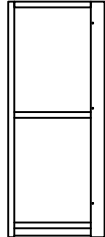
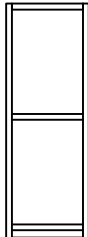
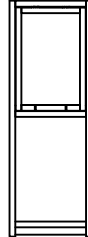
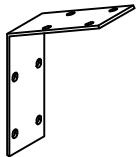





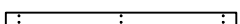



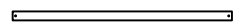

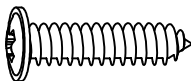

K2x1



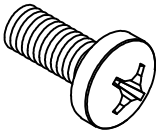
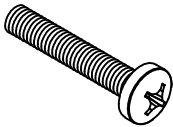

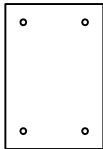
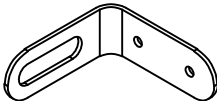

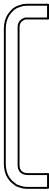
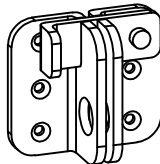
Lx4







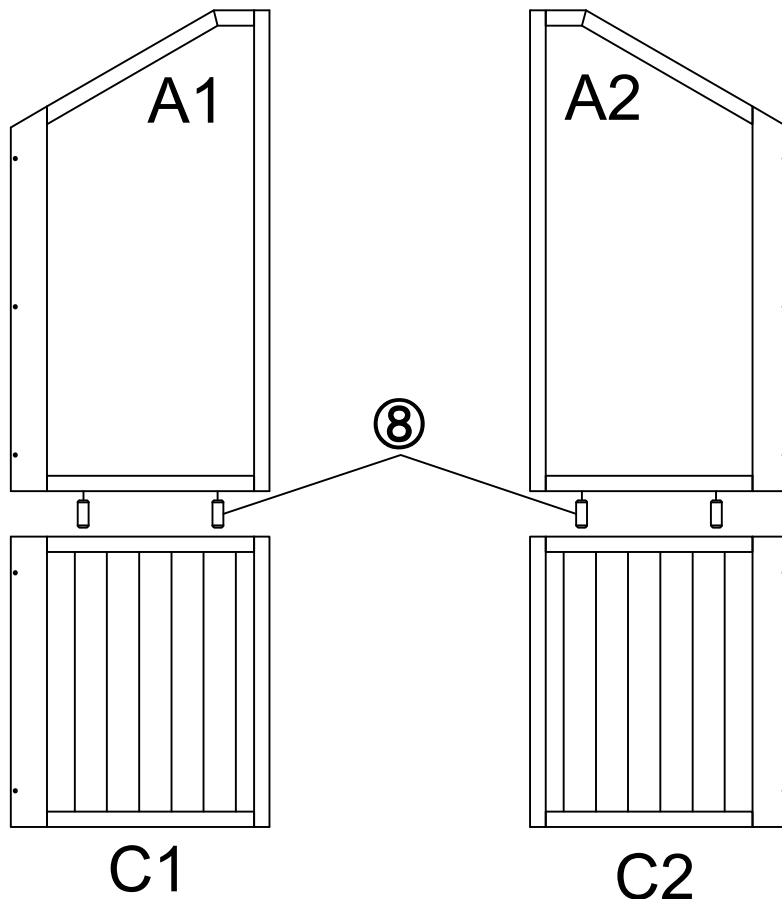

<b>A1x1</b> 	<b>A2x1</b> 	<b>B1x1</b> 	<b>B2x1</b> 		
<b>C1x2</b> 	<b>C2x2</b> 	<b>D1x1</b> 	<b>D2x1</b> 		
<b>E1x1</b> 	<b>E2x1</b> 	<b>Fx2</b> 	<b>Gx1</b> 		
<b>Hx4</b> 	<b>I1x2</b> 	<b>I2x2</b> 	<b>Jx10</b> 	<b>K1x2</b> 	
<b>K2x2</b> 	<b>Lx10</b> 	<b>Mx2</b> 	<b>Ox1</b> 	<b>Qx2</b> 	
<b>Rx2</b> 	<b>Sx8</b> 	<b>Tx2</b> 	<b>Ux18</b> 	<b>V1x2</b> 	<b>V2x2</b> 
<b>W1x1</b> 	<b>X1x2</b> 	<b>X3x4</b> 	<b>Y1x12</b> 	<b>Y3x1</b> 	
<b>W2x1</b> 	<b>X2x4</b> 	<b>X4x4</b> 	<b>Y2x2</b> 	<b>Zx2</b> 	

<p>①x156+2</p>  <p>M3*14mm</p>	<p>②x71+2</p>  <p>M3*14mm</p>	<p>③x10+1</p>  <p>M3.5*30mm</p>	<p>④x90+2</p>  <p>M3.5*35mm</p>	<p>⑤x24+1</p>  <p>M3.5*50mm</p>
<p>⑥x144+2</p>  <p>M6*15mm</p>	<p>⑦x4</p>  <p>M4*25mm</p>	<p>⑧x146+2</p>  <p>wood stick φ8*20mm</p>	<p>⑨x35</p> 	
<p>⑩x24</p> 	<p>⑪x4</p> 	<p>⑫x2</p> 	<p>⑬x1</p> 	<p>⑭x90+2</p>  <p>M3.5*25mm</p>

PART	NO	QIT
	A1	1
	A2	1
	C1	1
	C2	1
 wood stick	⑧	4



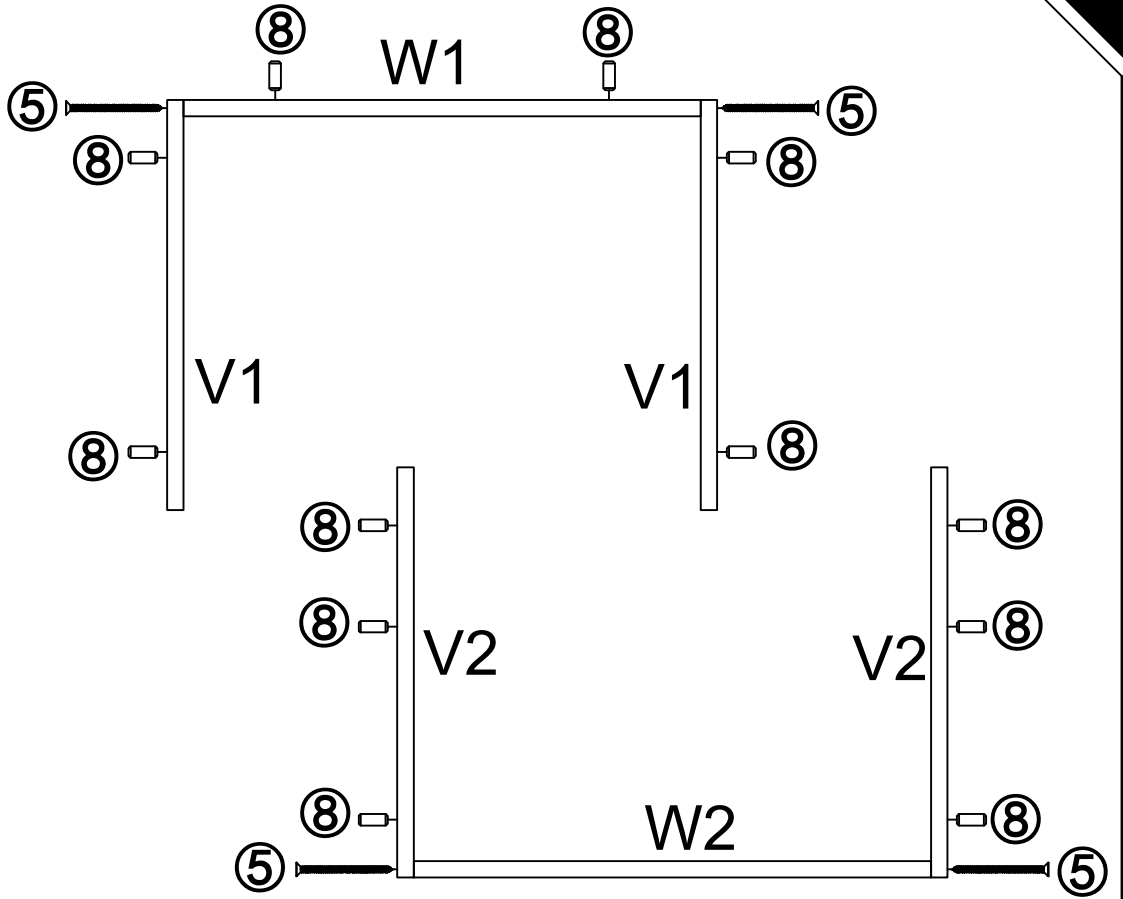

PART	NO	QIT
	V1	2
	V2	2
	W1	1
	W2	1
	⑤	4
 wood stick	⑧	12



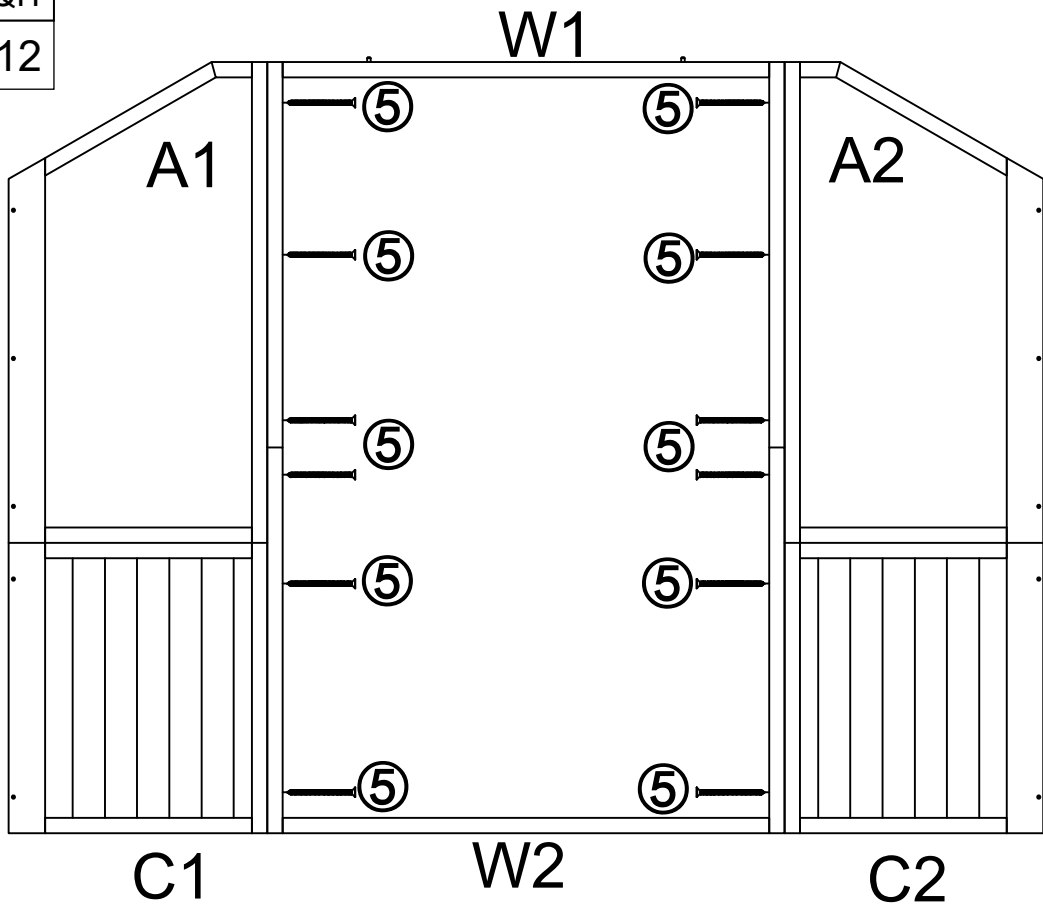

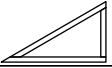

PART	NO	QIT
	⑤	12

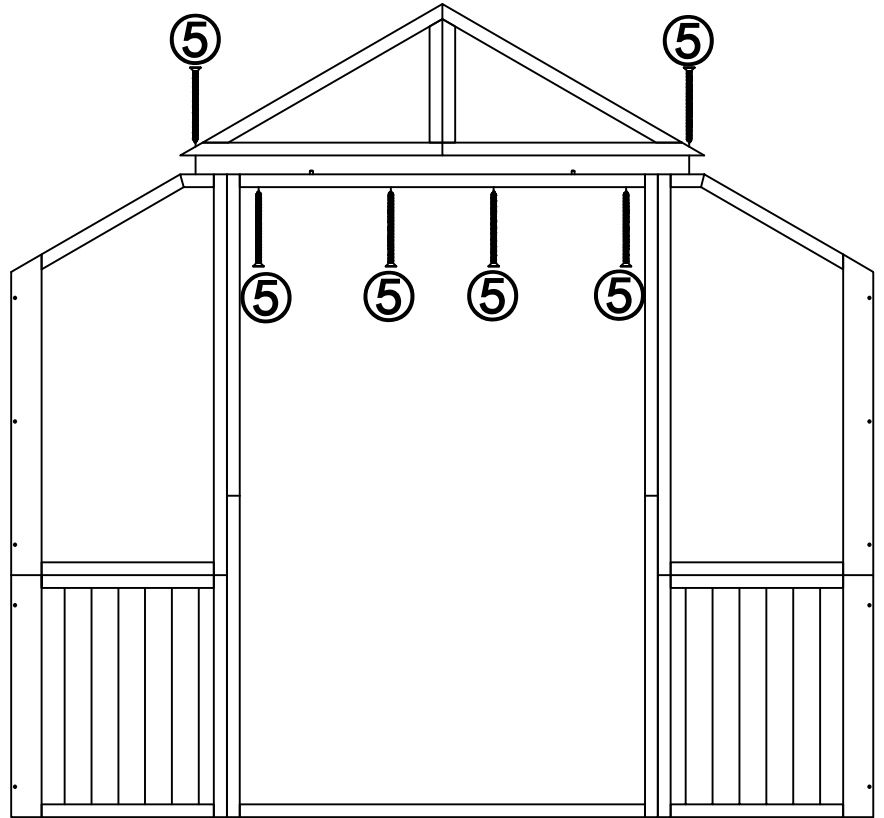
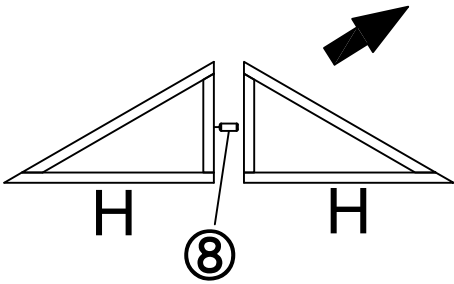

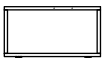
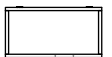



PART	NO	QIT
	H	2
	5	6
 wood stick	8	1

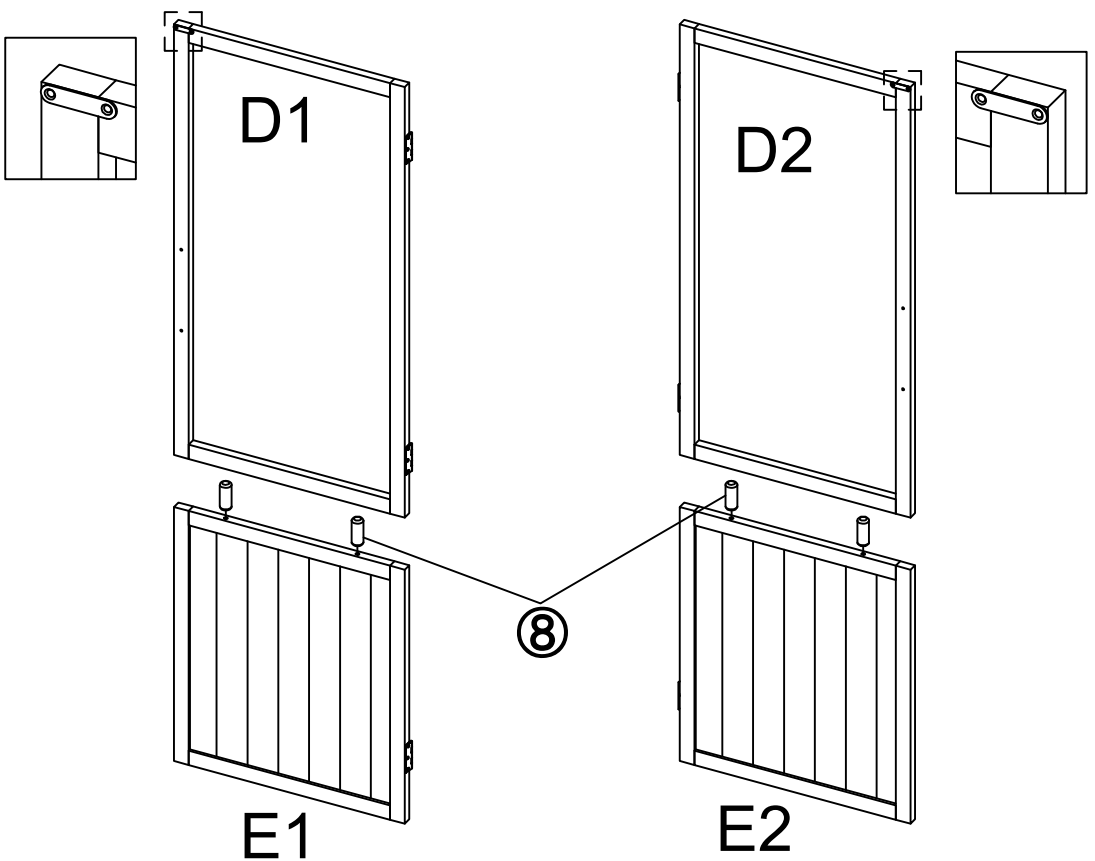

PART	NO	QIT
	D1	1
	D2	1
	E1	1
	E2	1
 wood stick	8	4

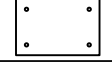

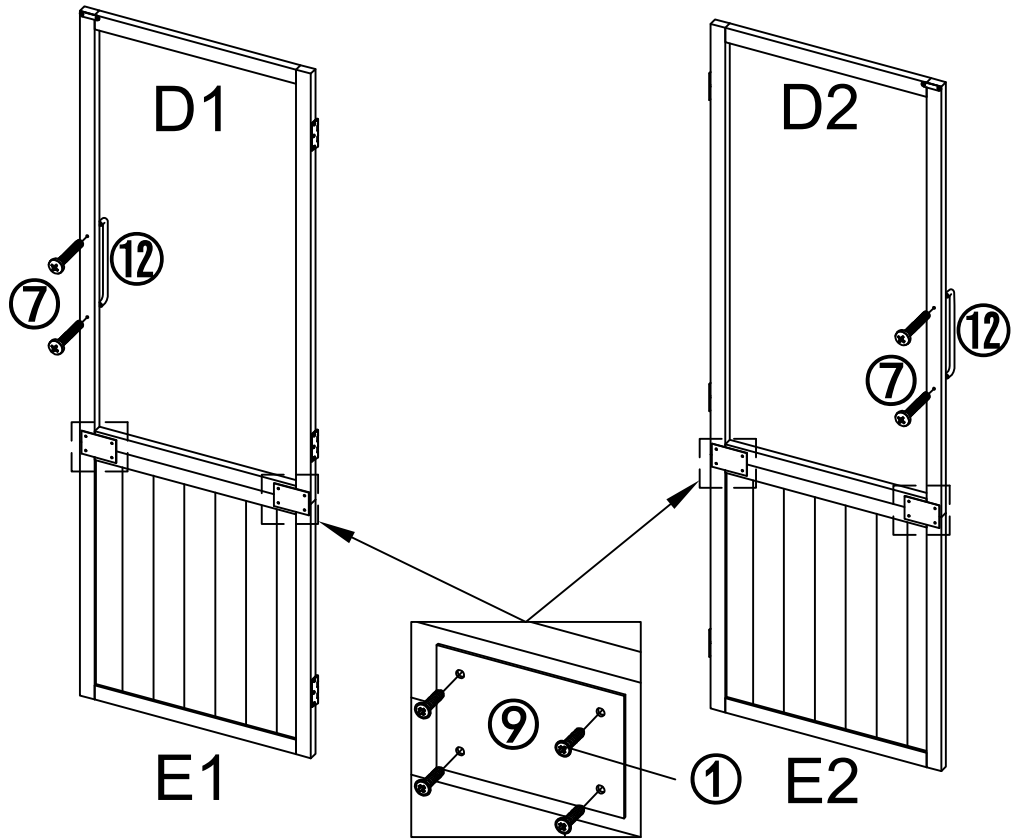

PART	NO	QIT
	①	16
	⑦	4
	⑨	4
	⑫	2



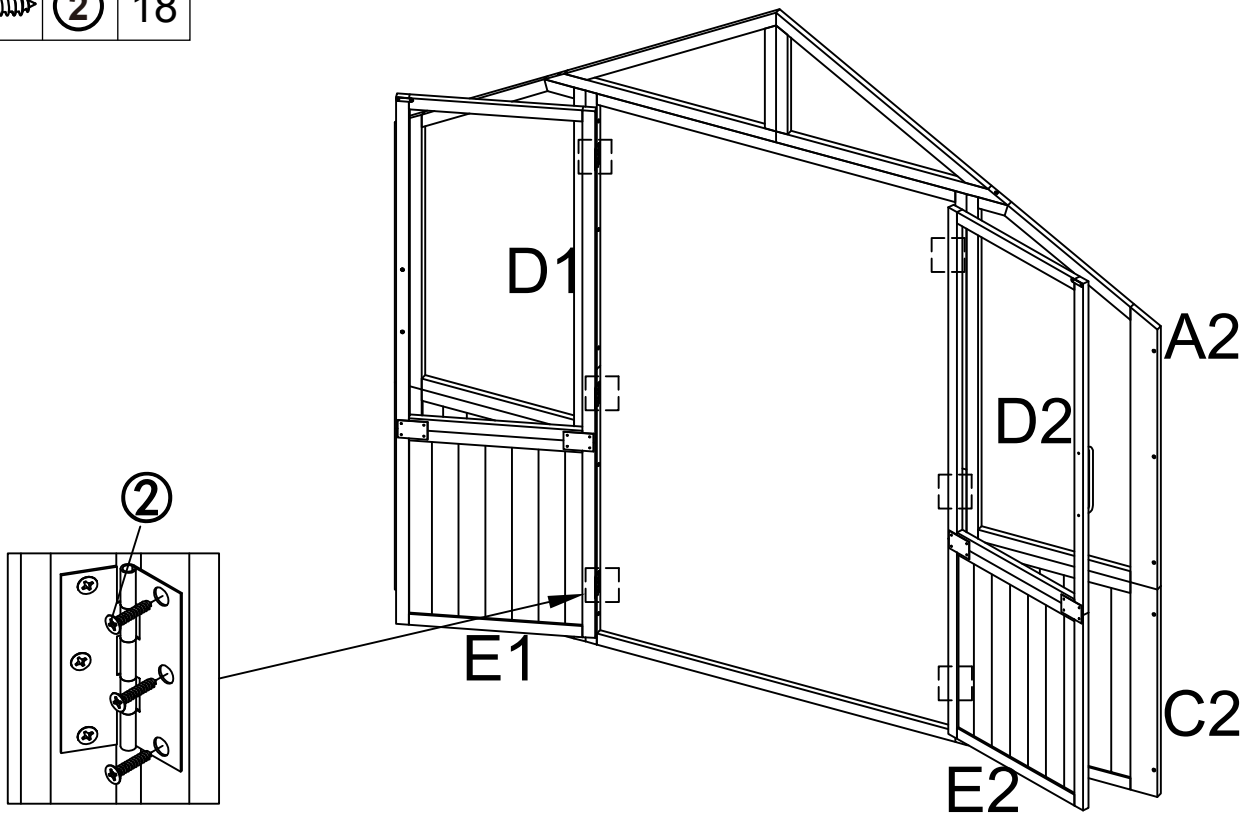

PART	NO	QIT
	②	18



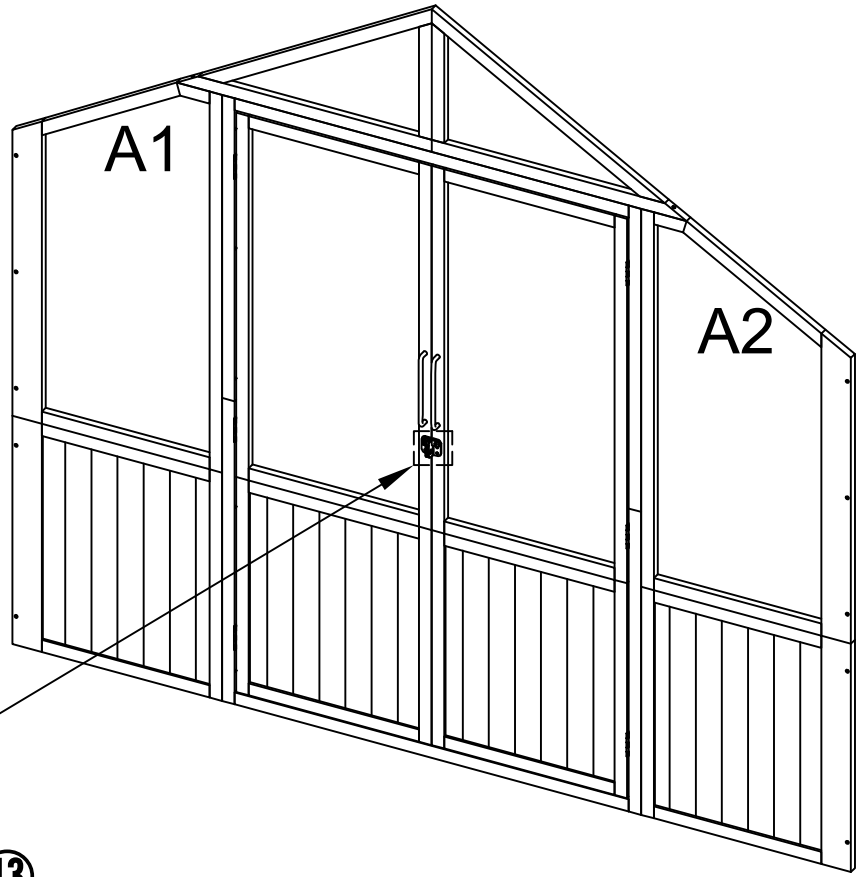
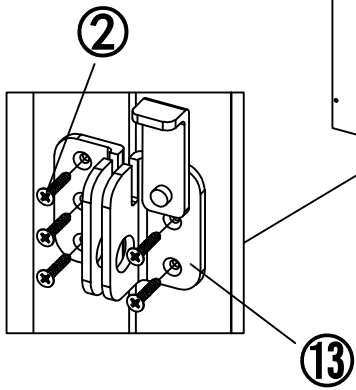

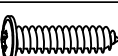
PART	NO	QIT
	②	5
	⑬	1

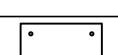

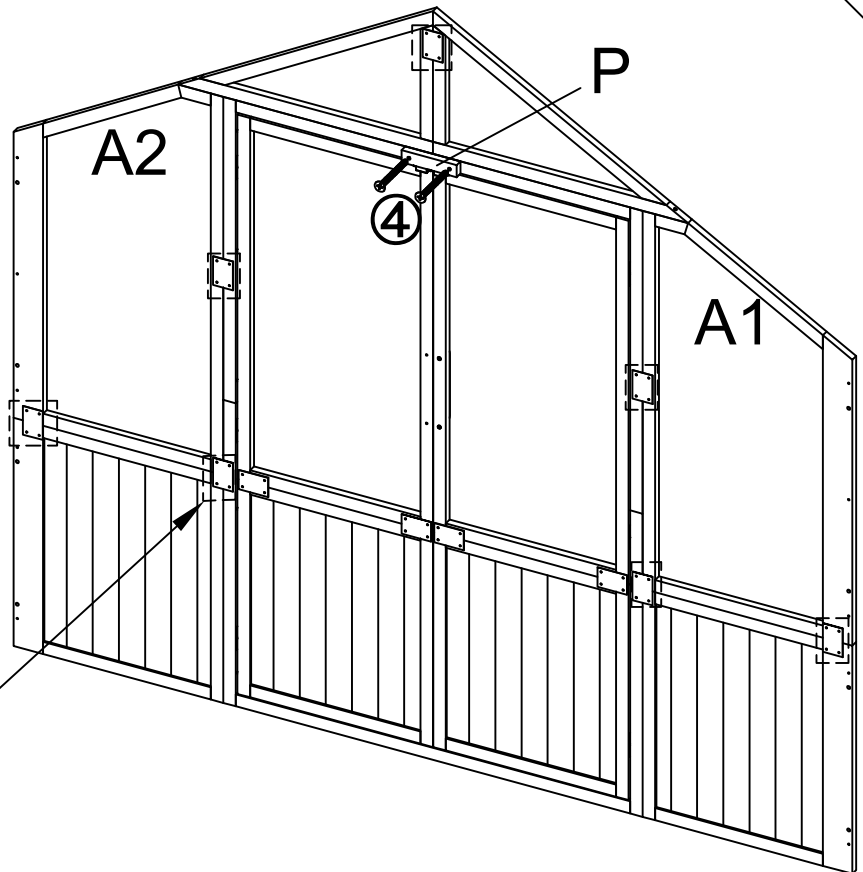
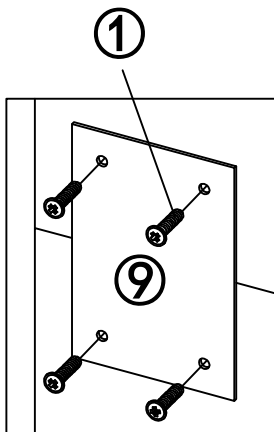

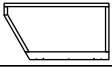
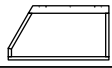
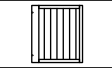
PART	NO	QIT
	P	1
	①	28
	④	2
	⑨	7



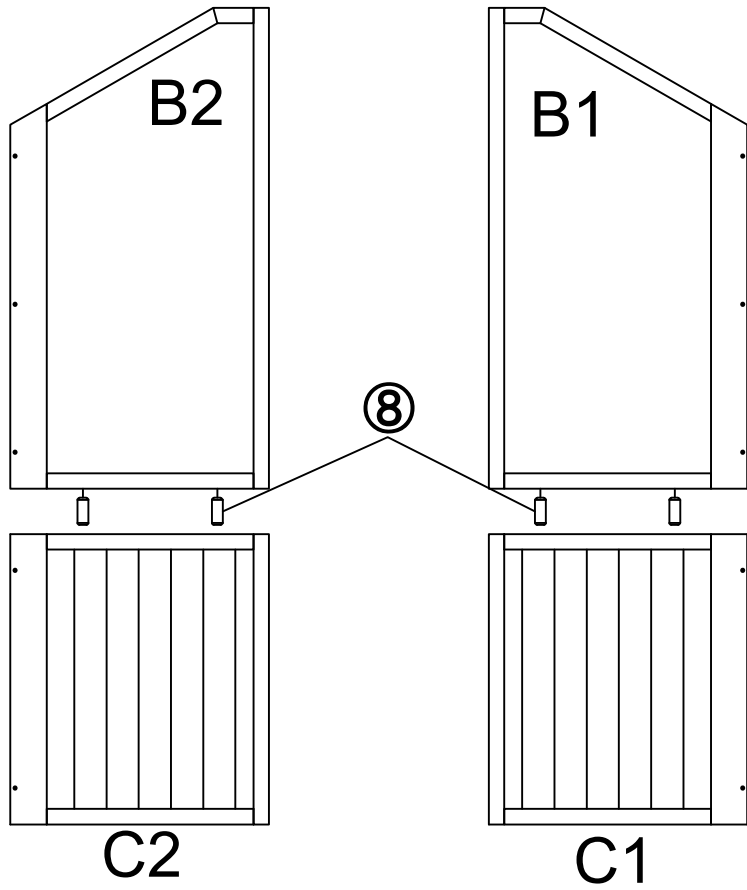

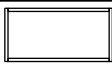
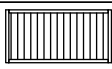
PART	NO	QIT
	B1	1
	B2	1
	C1	1
	C2	1
 wood stick	⑧	4



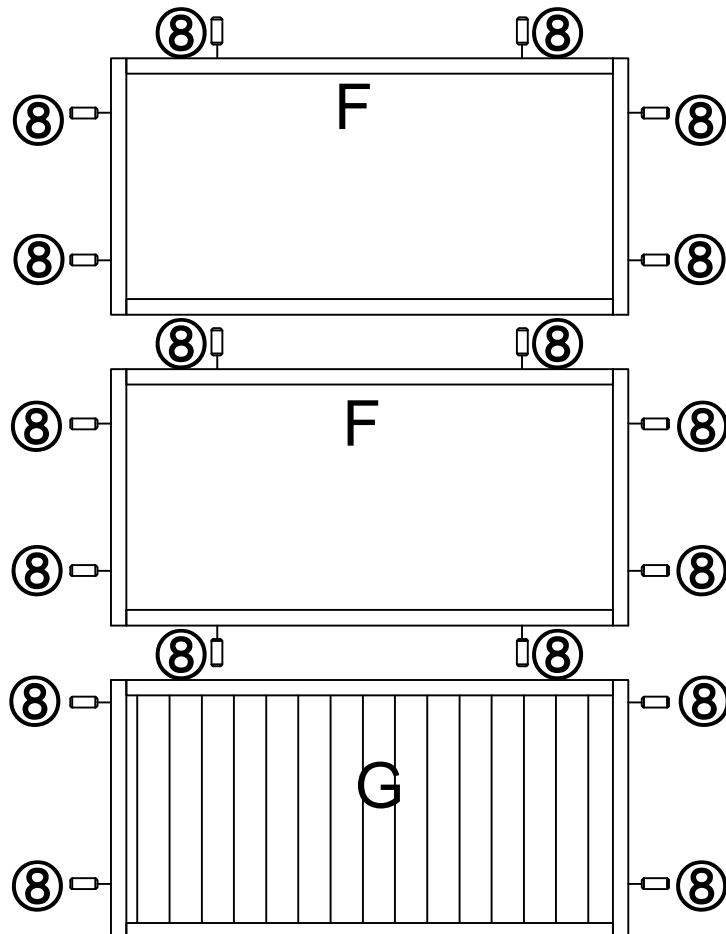

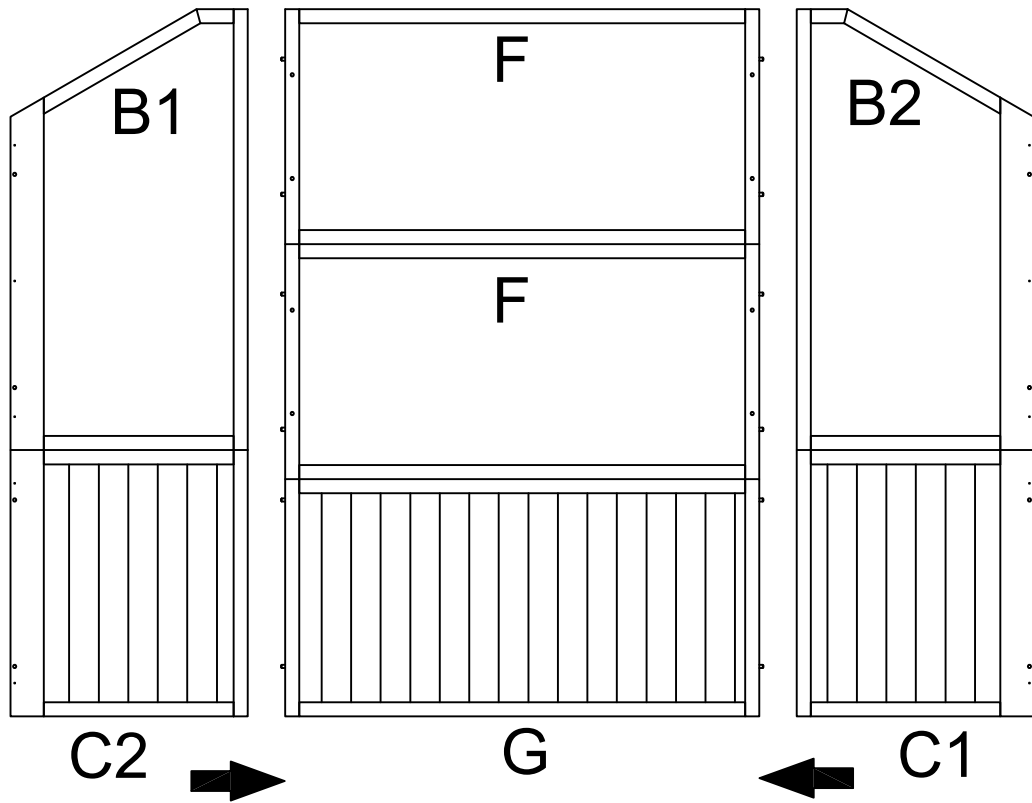
PART	NO	QIT
	F	2
	G	1
 wood stick	⑧	18

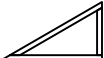



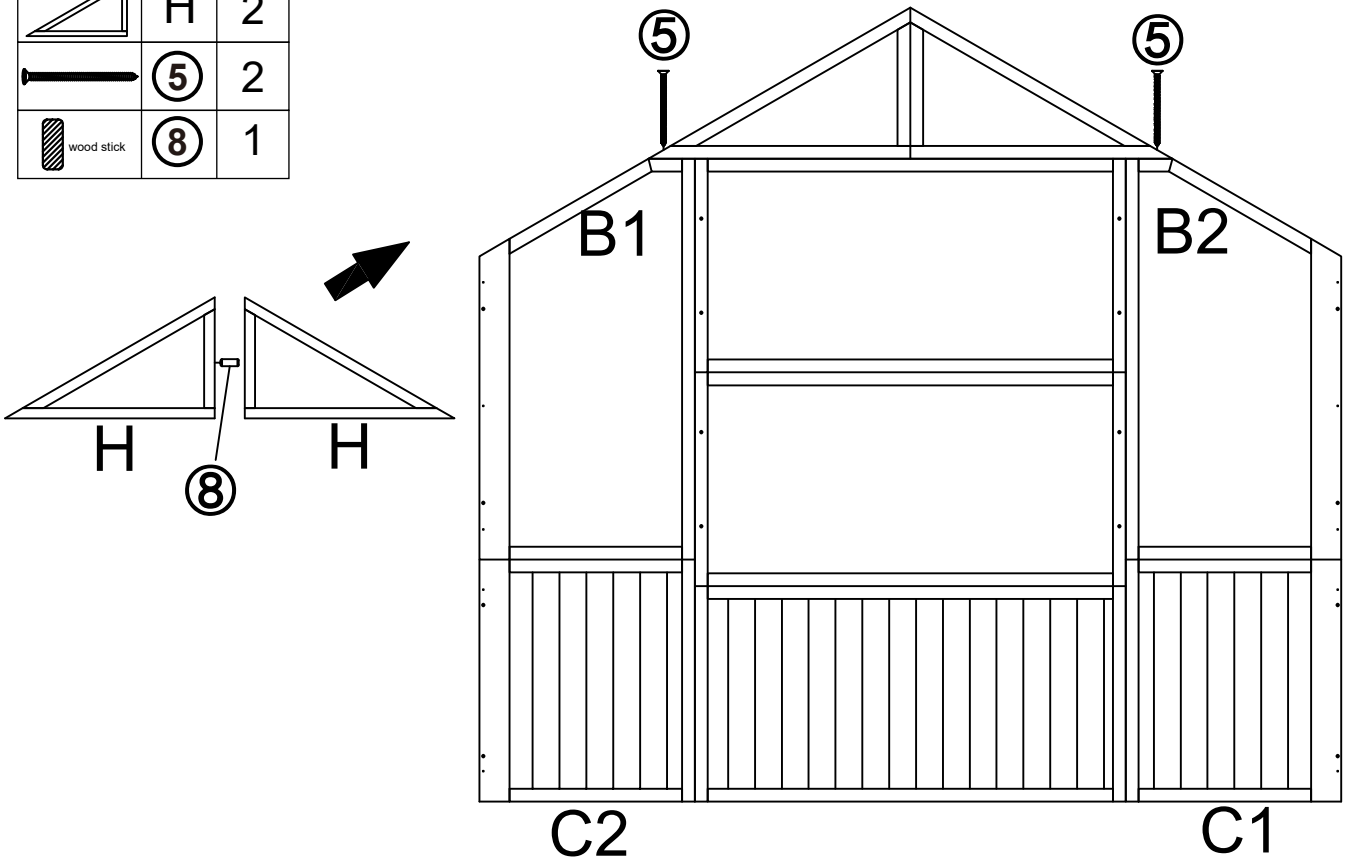

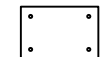

PART	NO	QIT
	H	2
	⑤	2
 wood stick	⑧	1

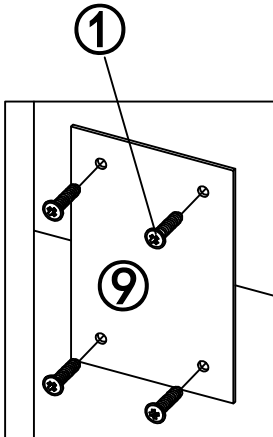
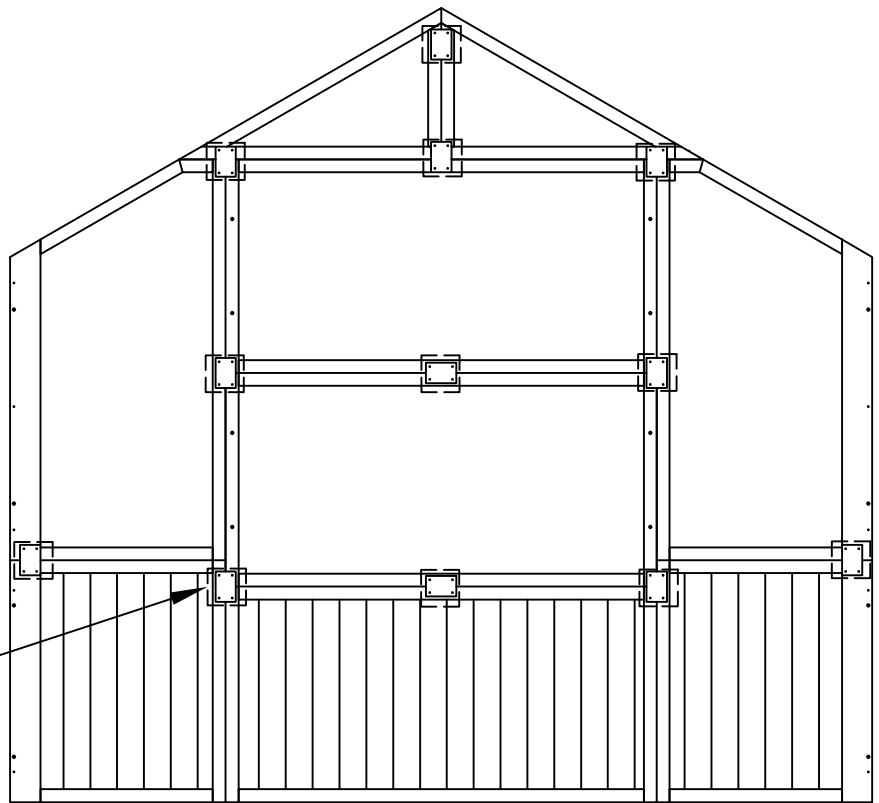

PART	NO	QIT
	①	48
	⑨	12



PART	NO	QIT
	X4	4
	③	8
 wood stick	⑧	8

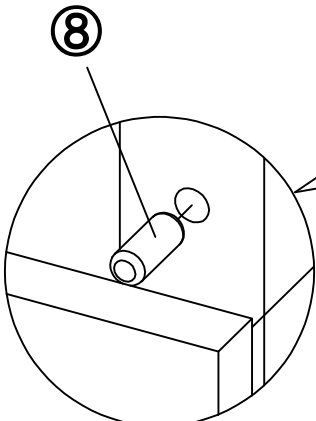
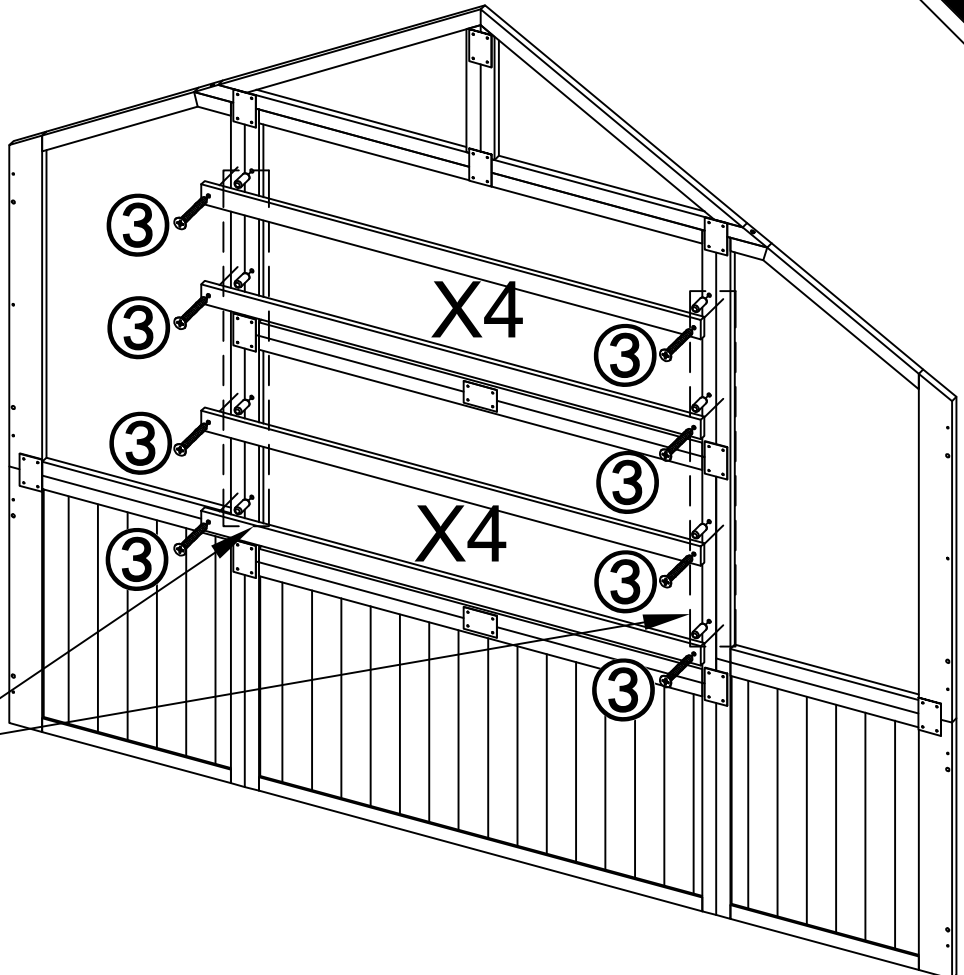

PART							
NO	I1	I2	J	K1	K2	L	⑧
QIT	2	2	10	2	2	10	28

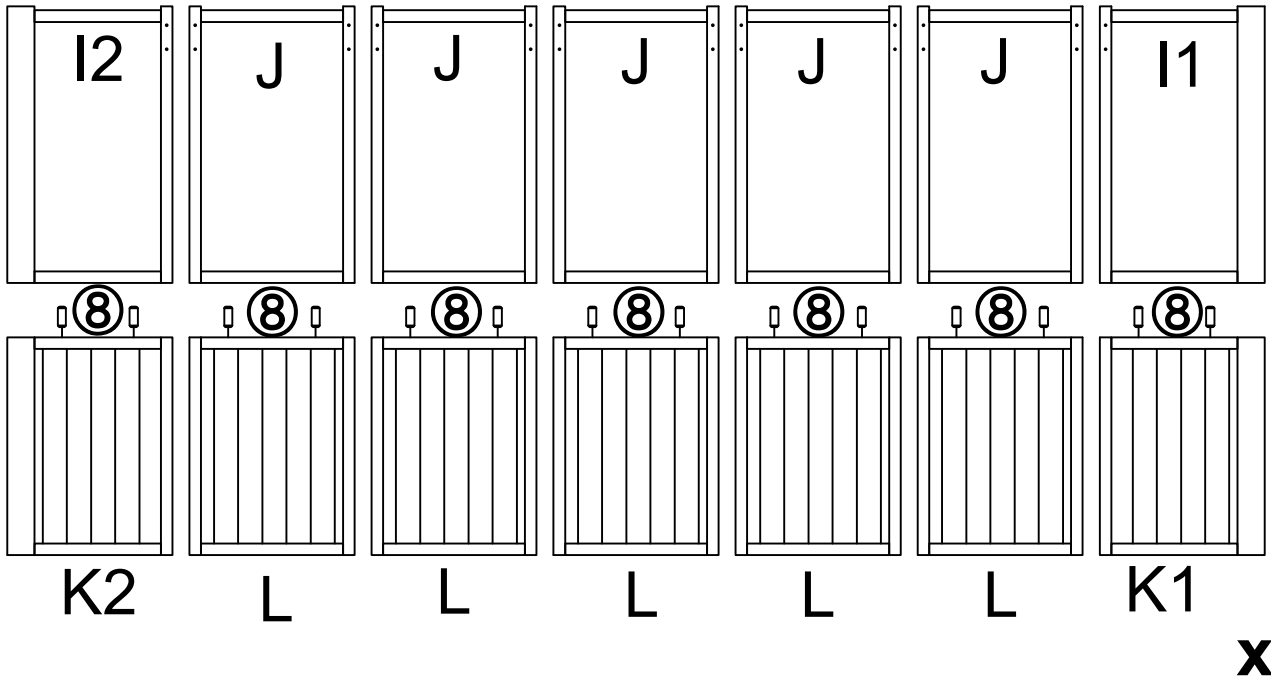

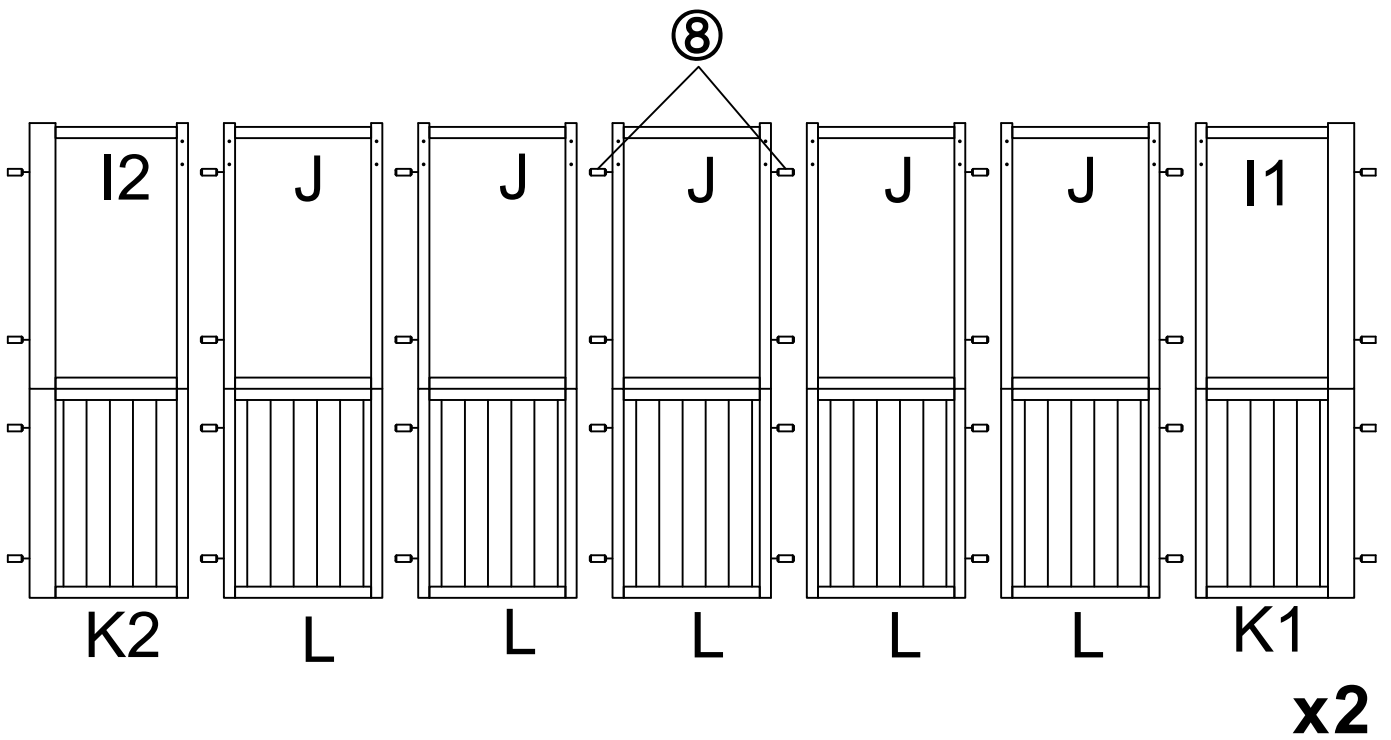

PART	
NO	⑧
QIT	64

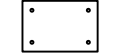

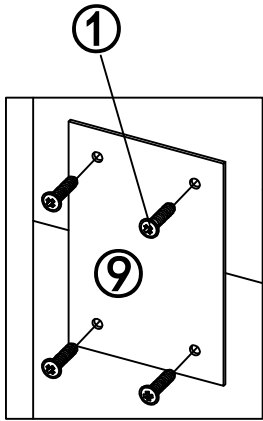
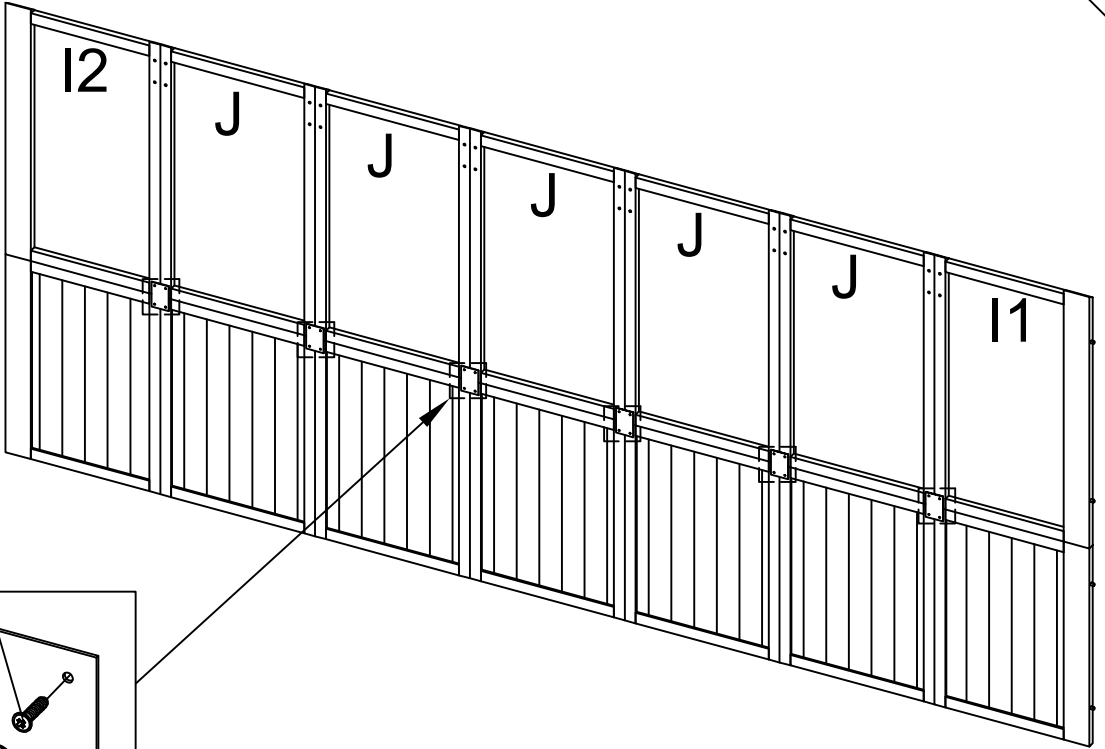
PART	NO	QIT
	①	48
	⑨	12



x2

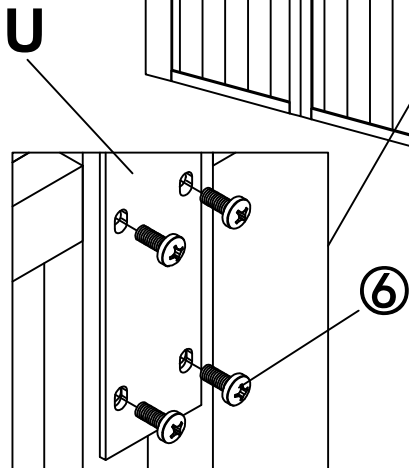
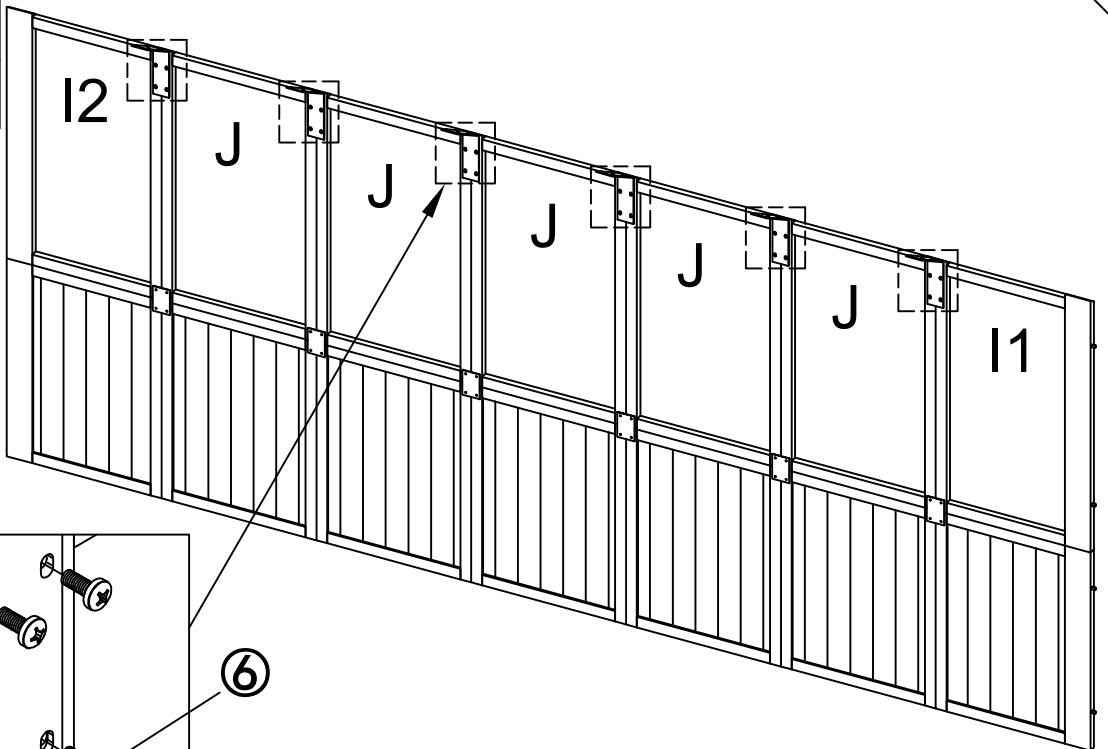

PART	NO	QIT
	U	12
	⑥	48



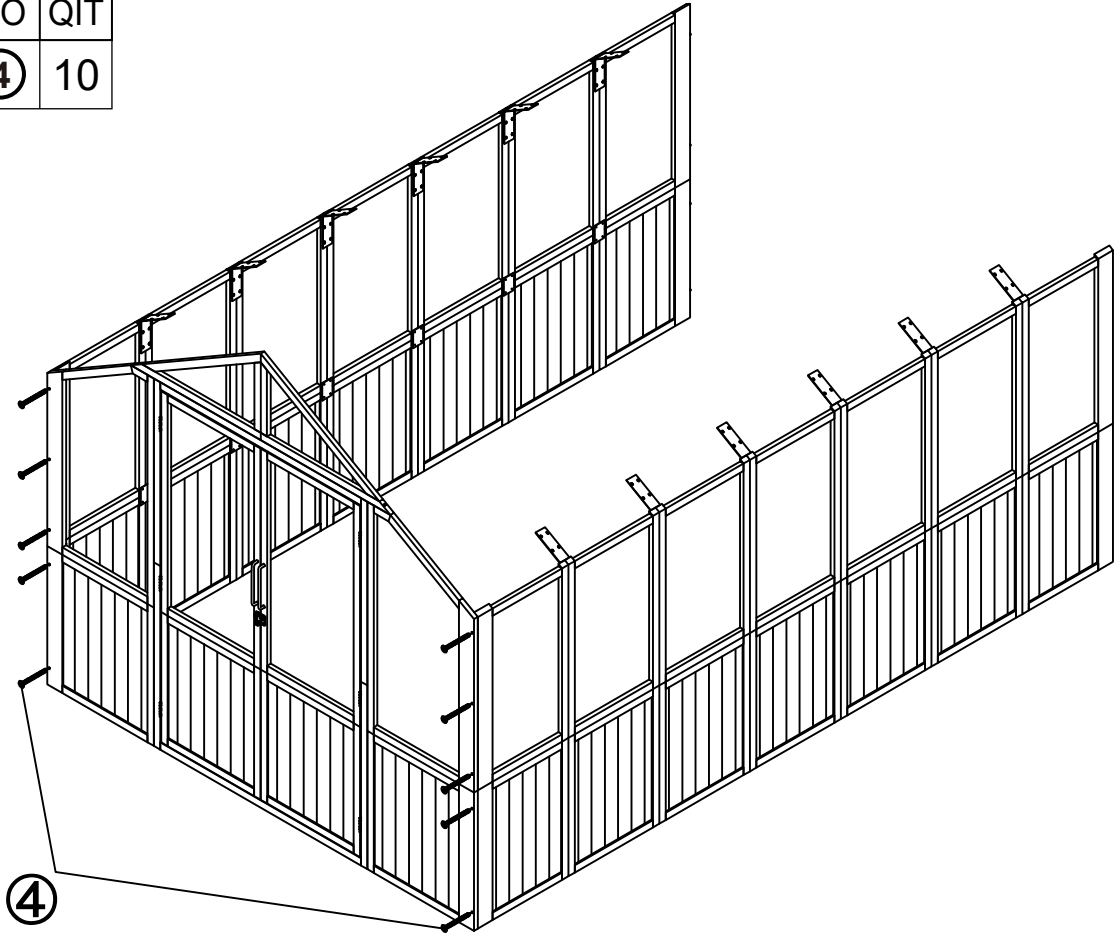

x2

PART	NO	QIT
	④	10



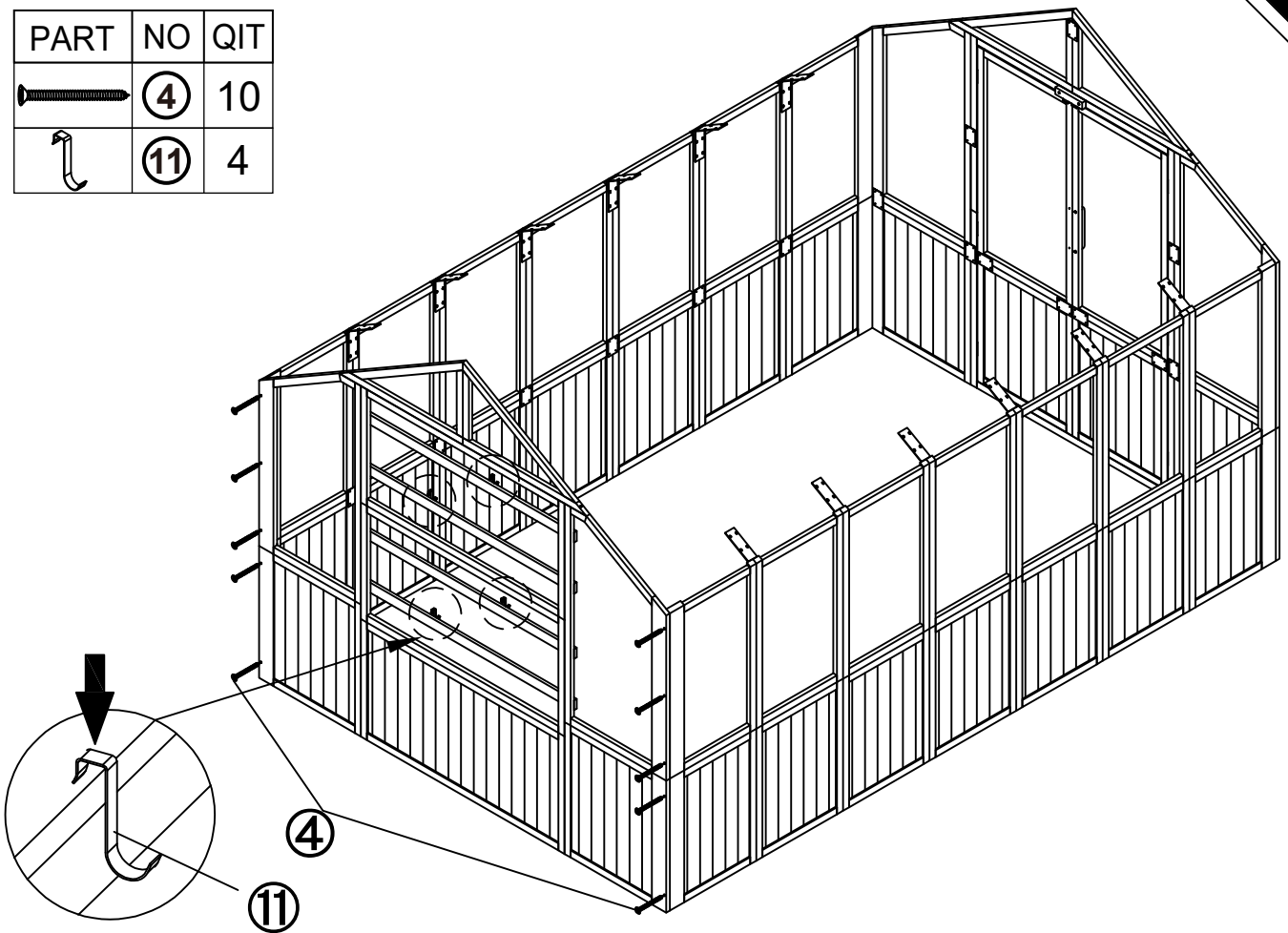

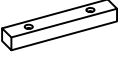
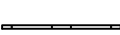
PART	NO	QIT
	④	10
	⑪	4



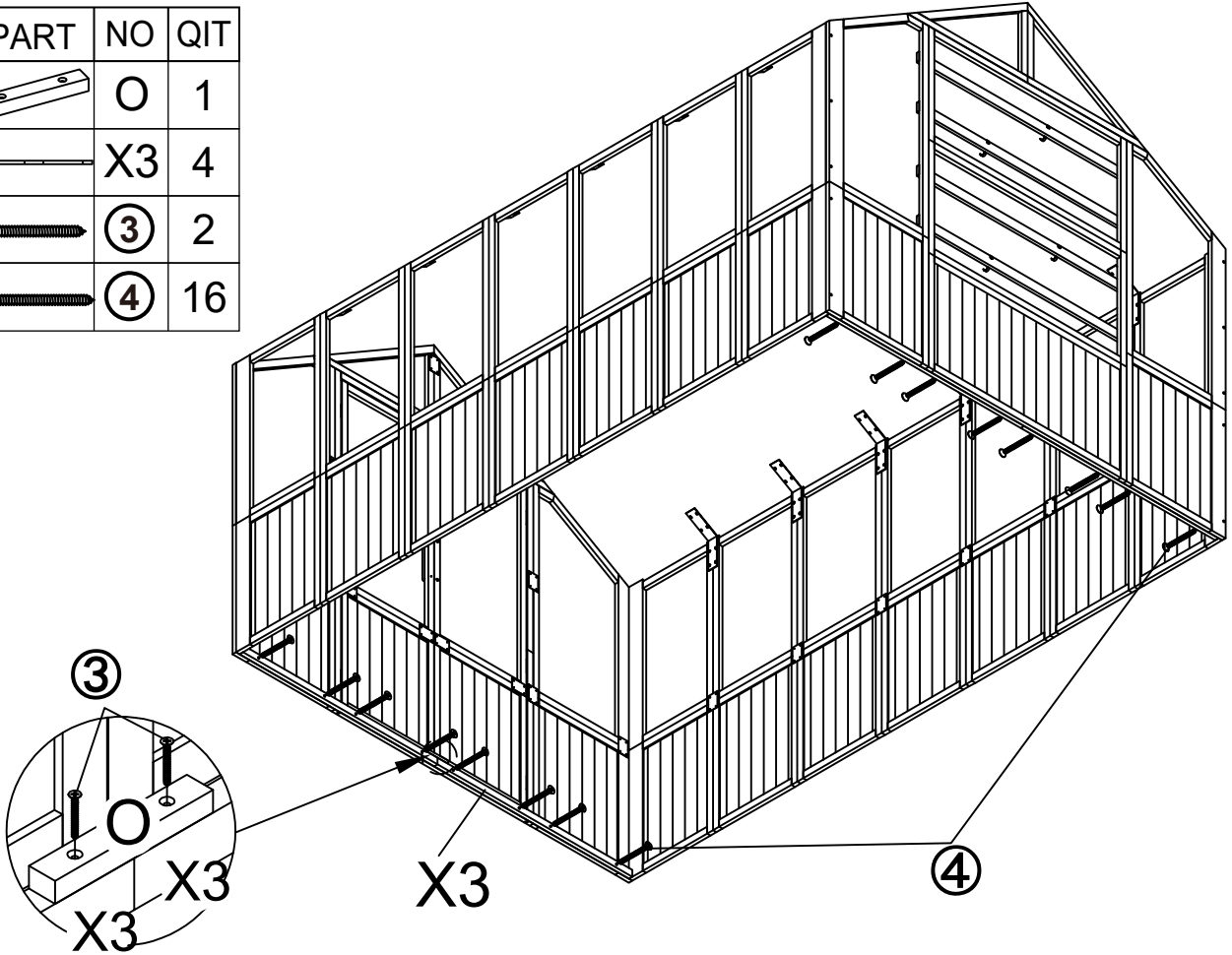

PART	NO	QIT
	O	1
	X3	4
	③	2
	④	16



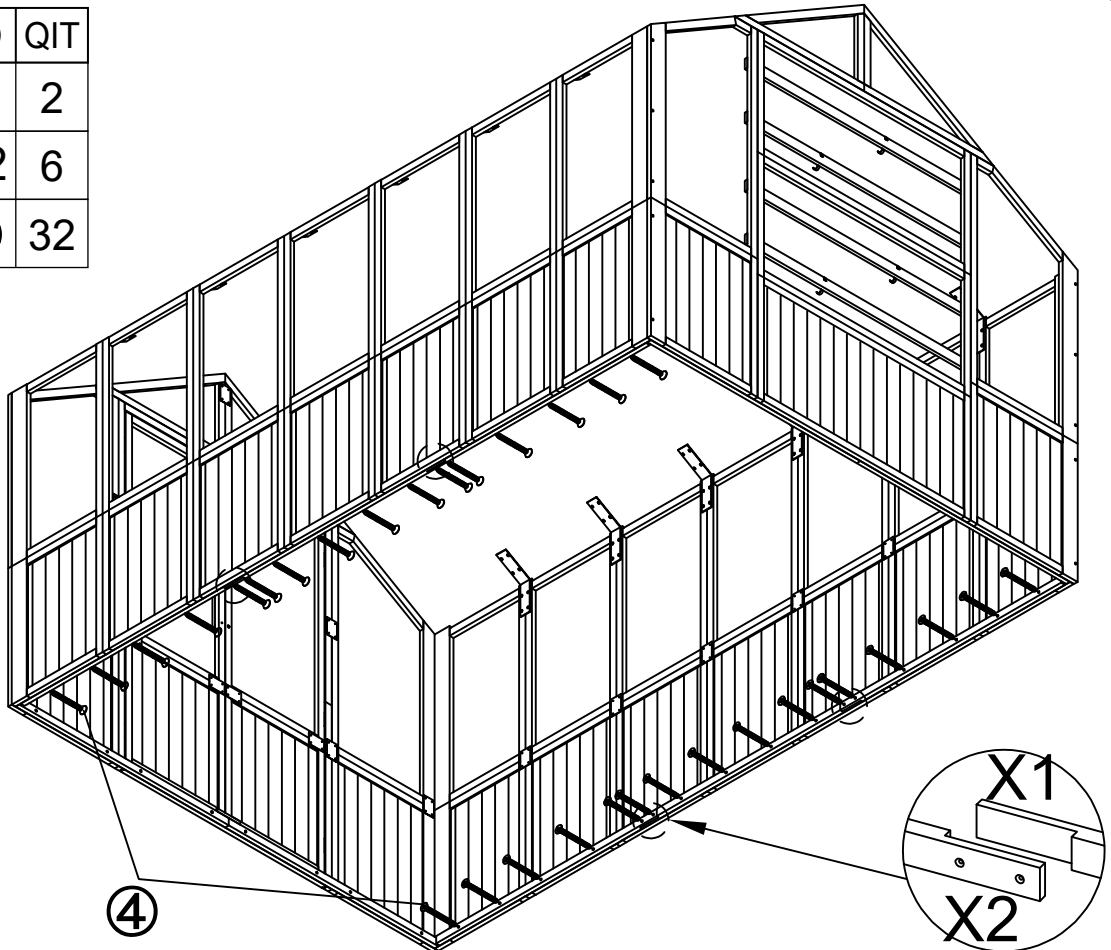

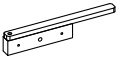
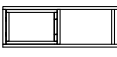

PART	NO	QIT
	X1	2
	X2	6
	④	32

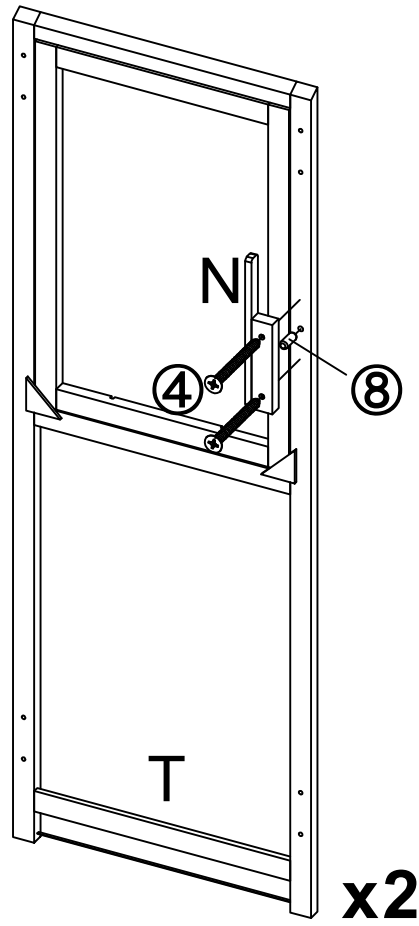

PART	NO	QIT
	N	2
	T	2
	④	4
 wood stick	⑧	2

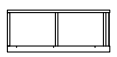
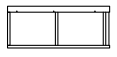

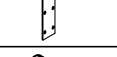

x2

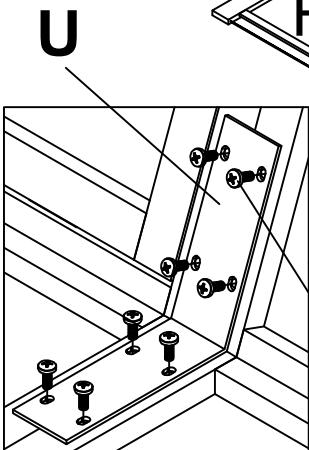
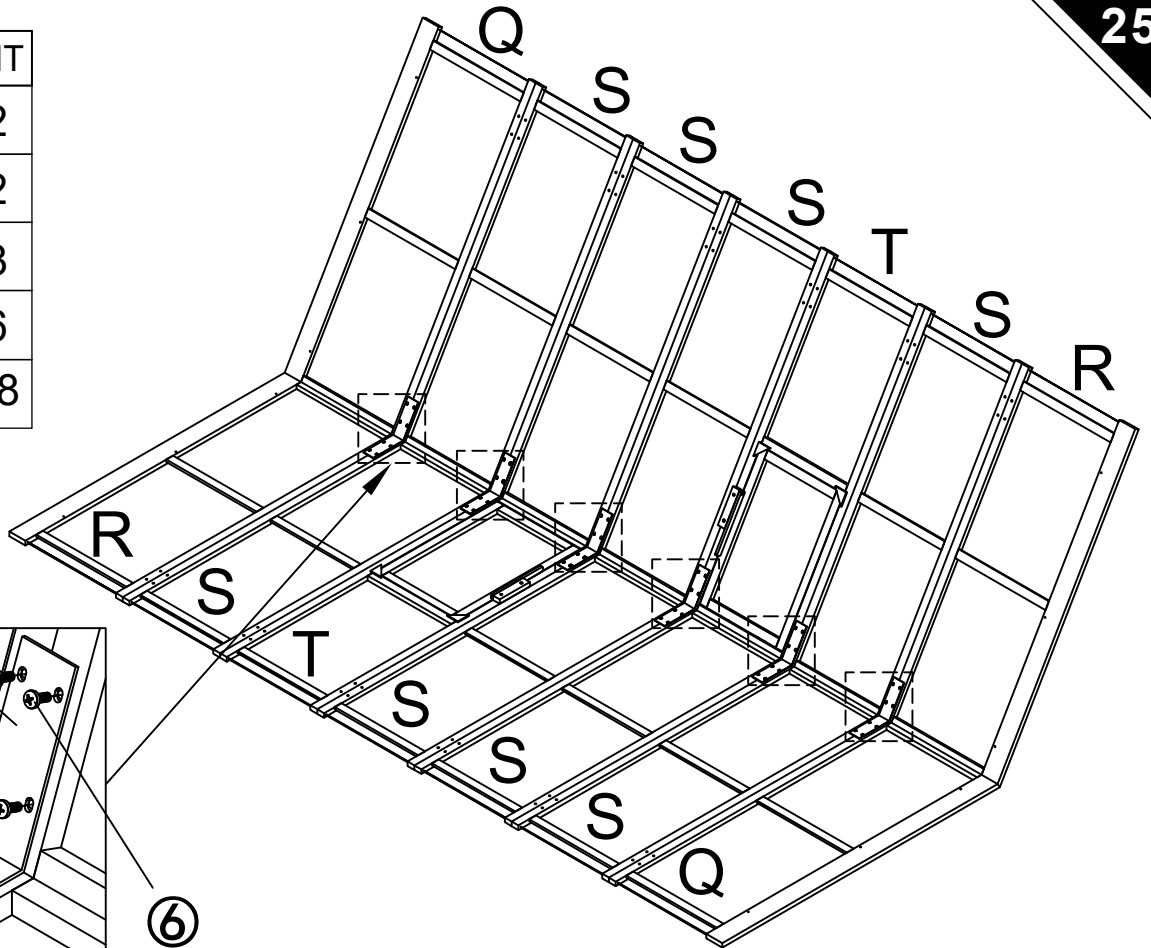
PART	NO	QIT
	Q	2
	R	2
	S	8
	U	6
	⑥	48



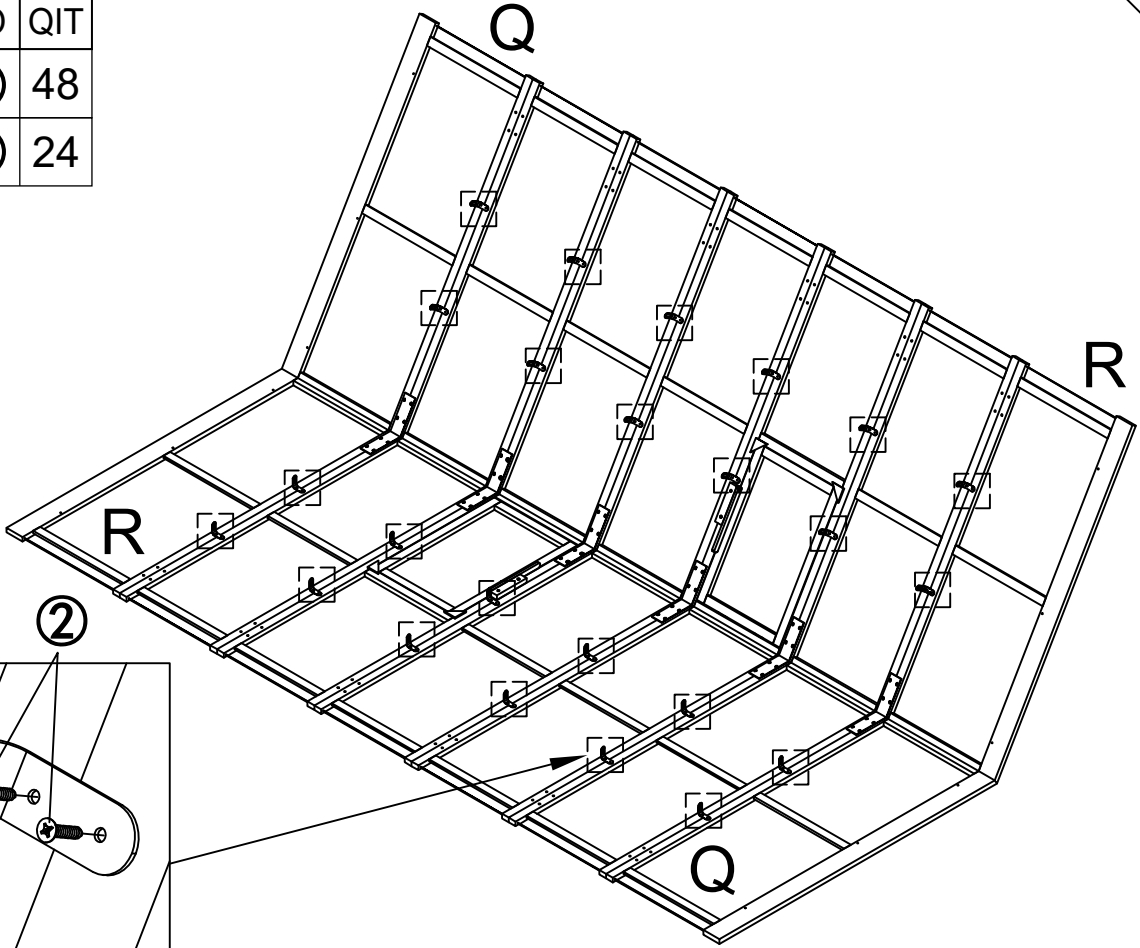

⑥

PART	NO	QIT
	②	48
	⑩	24

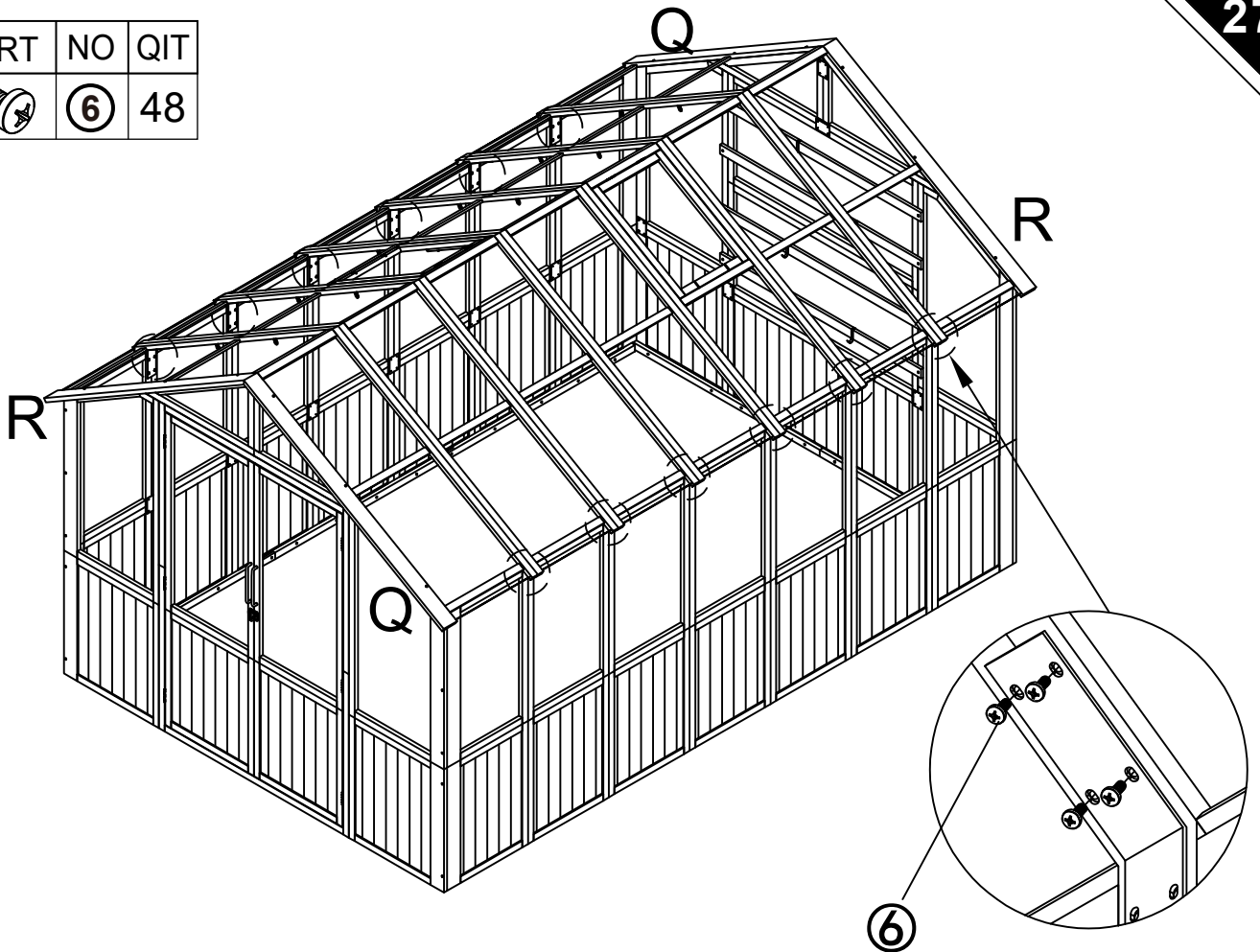

PART	NO	QIT
	⑥	48



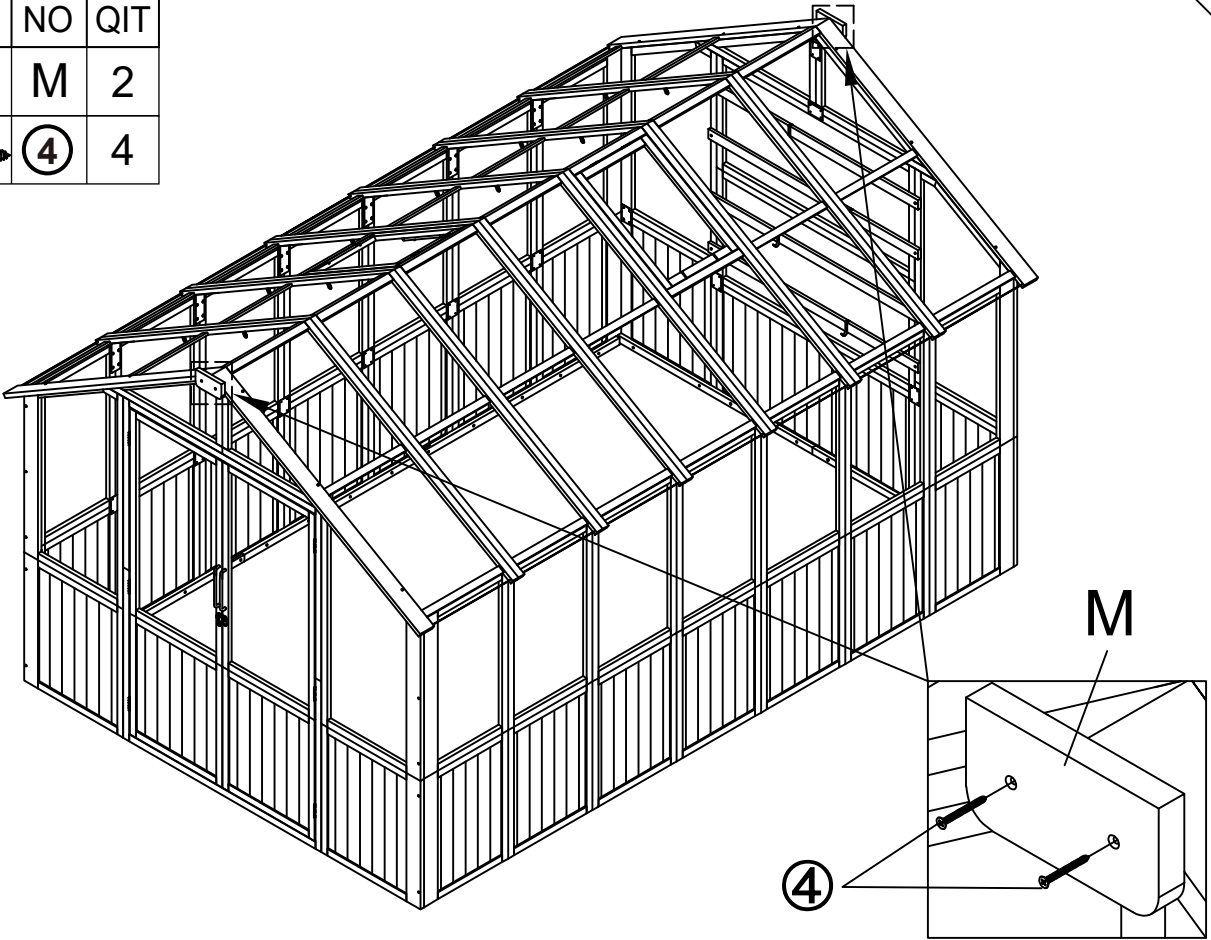

PART	NO	QIT
	M	2
	④	4



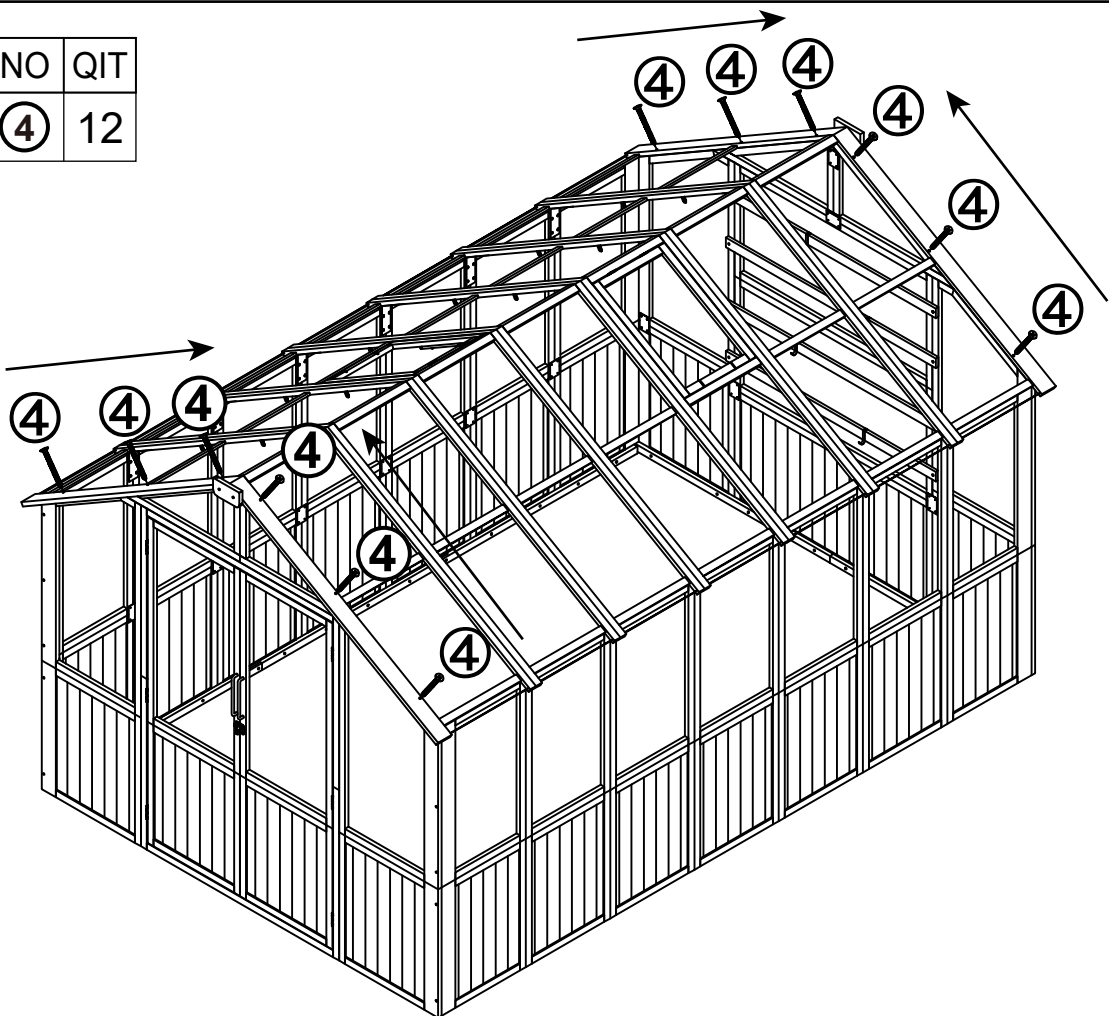

PART	NO	QIT
	④	12



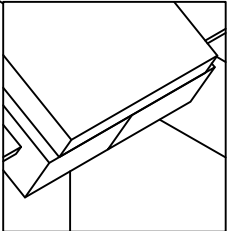
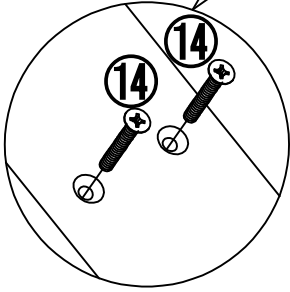
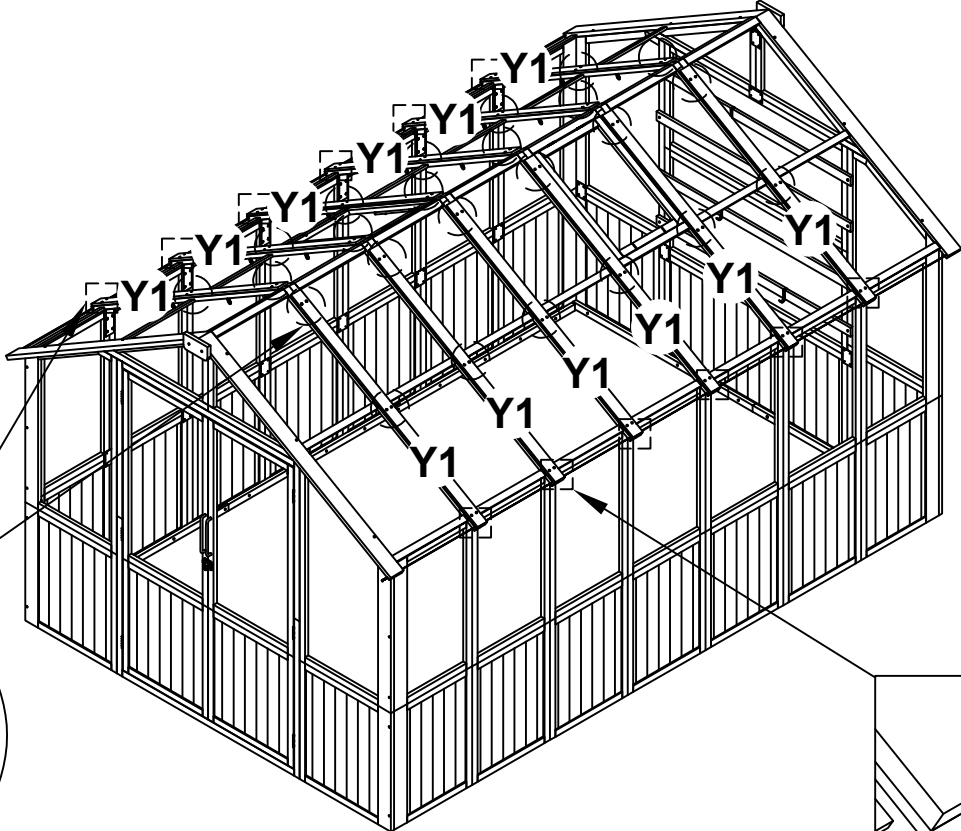

PART	NO	QIT
	Y1	12
	⑭	72

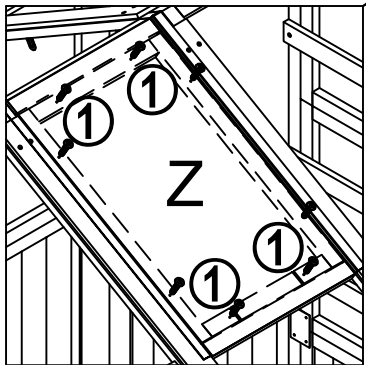
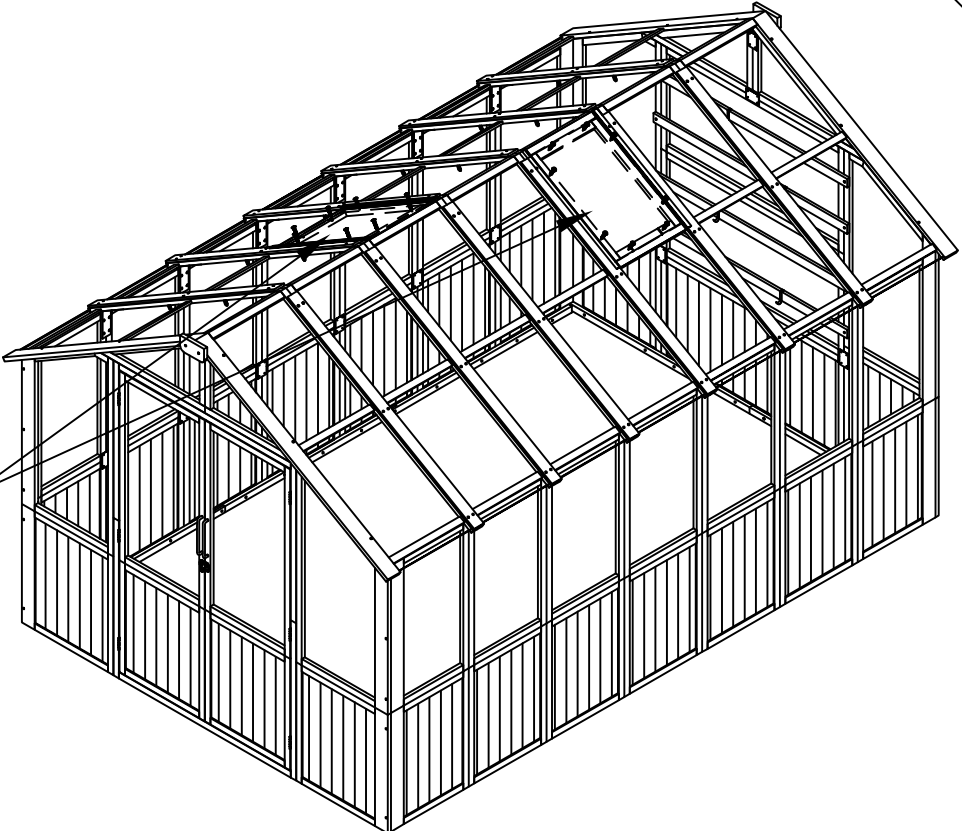

PART	NO	QIT
	Z	2
	①	16

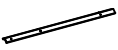

PART	NO	QIT
	Y2	2
	Y3	1
	14	18

