

Outdoor Wall Light

[Instruction Manual]

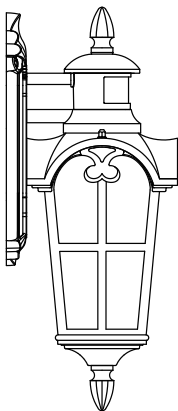

Please pay attention to the warning signs
Read the instructions with caution before operating
and keep it properly

Warning:

Risk of fire. Min 75°C supply conductors. Consult a qualified electrician to ensure correct installation. Before installation, please turn off the main power of the circuit breaker to prevent possible electric shock.

Packing list

IDX	ITEM NAME	SPEC	QUANTITY	NOTE
1	Wall light	16.85" x7"x6.3"	1 pc	
2	Wire connectors	P3	3 pcs	
3	Mounting screw	M4x25mm	2 pcs	
4	Instruction manual	A5 PAPER	1 pc	

Product specifications

- Input Voltage: 120VAC 60HZ
- Maxload Power: Incandescent Bulb 60W
- Socket Type: Standard medium E26(bulb not included)
- Material: Die-casting Aluminum and Water Ripple Glass
- Certification: ETL

Installation Instructions

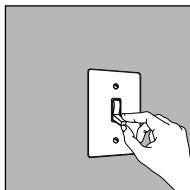

FIG.1 WALL SWITCH

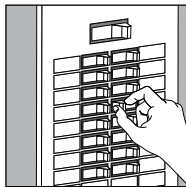

FIG.2 BREAKER PANEL

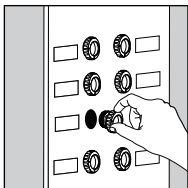

FIG.3 FUSE BOX

STEP 01: POWER OFF

FIG.1. Turn the wall switch to the "OFF" position.

Depending on which type of fuse box in your home:

FIG.2. Either turn the main (Master) switch to the "OFF" position to cut off the power supply of the entire home, or turn off the individual switch that supplies power to the fixture installation location.

OR

FIG.3. Either turn the main (Master) switch to the "OFF" position to cut off the power supply of the entire home, or unscrew the fuse that supplies or turn off the individual switch that supplies power to the fixture installation location.

STEP 02: CLEAN THE LIGHT

Cleaning: Cleaning the glass and photocell sensor surface of the post light with a soft and damp cloth. Dust will affect the sensitivity of photocell and brightness of the post light.

STEP 03: CONNECT THE WIRE

Connect black live wire, white neutral wire and ground wire with wire connectors, be sure that the wires are connected together sturdily.

STEP 04: FIX THE LIGHT

Fix the lamp on the wall with mounting screws, unload the light body by taking off two screws, install A19 bulb (E26 base) in the wall light.
(Not included)

STEP 05: POWER ON

Turn on the main (Master) switch to get the power back, the light will turn on automatically at dusk and off at dawn.

The lamp structure is described as following picture:

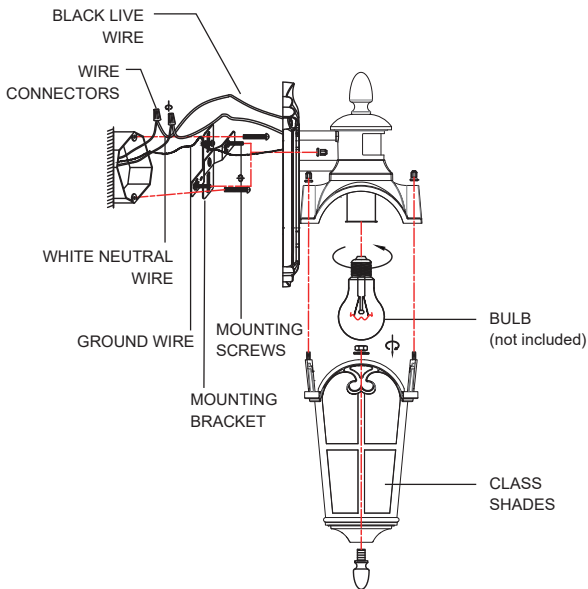

Operation description

- (1) Turn on the light, wait 30 seconds for the sensor to warm up, then select one function.
- (2) Unscrew the top knob and top cover, then you can adjust different modes, sensitivity and delay time. Reinstall the top knob and cover after completing the setting to ensure waterproofing reliability, as shown in Figure 1~4.

Remark:

The lighting time can be adjusted. Factory setting is AUTO mode (20 second, the maximum preset induction distance is 10 meters.)

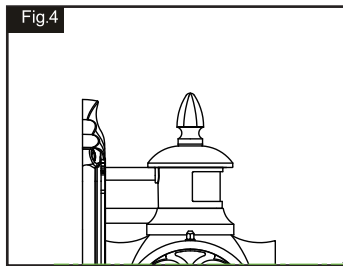
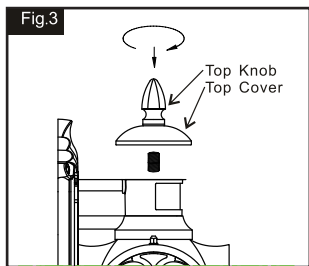
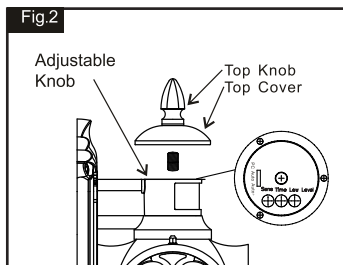
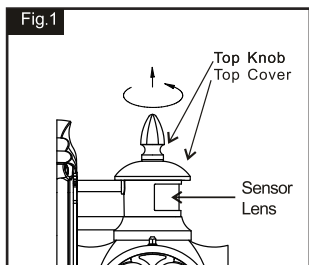

AUTO MODE - Set the slide switch to AUTO. The fixture will stay off at daytime and automatically turn on when human body activity is sensed at night. It automatically turns off when the person leaves or remains stationary for 20-180 seconds(according to the time you set). The factory preset time is 20s and the brightness is 100%.

TIME - Adjust Lighting Time: Adjust the "Time" knob with a flat head screwdriver(Not Included). Turn clockwise to increase the lighting time, and counterclockwise to decrease the lighting time. For every 1/4 clockwise

rotation, the lighting time increases by 60 seconds. The maximum is 180 seconds.

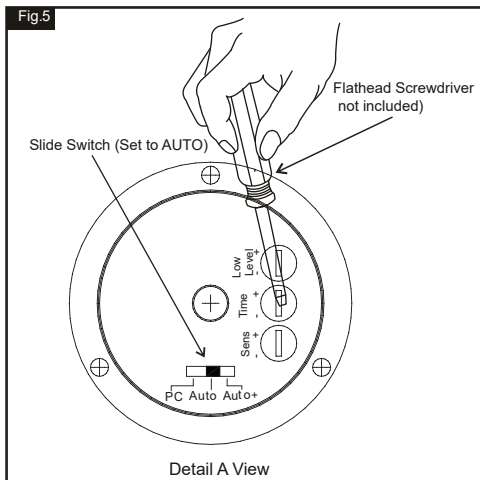

SENS - Adjust Sensing Distance: Adjust the “Sens” knob with a flat head screwdriver(Not Included). Turn clockwise to increase sensing distance, and counterclockwise to decrease the sensing distance. The factory preset distance is 10M(Maximum), you can adjust the “Sens” knob to set it in the range of 3-10 meters.

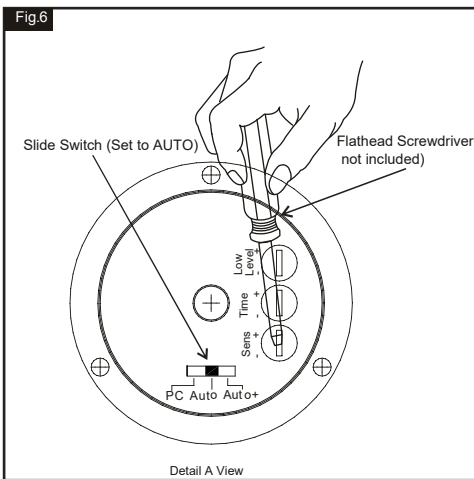

LOW LEVEL - This function is out of work in AUTO mode.

4. **AUTO+ MODE:** Set the slide switch to AUTO+. The fixture will stay OFF at daytime and stay low-level brightness (20%-50% brightness to be manually adjusted) at night if no motion is detected within 20-180 seconds, and automatically adjust the brightness to 100% when human body activity is sensed at night. It returns to the preset low-level brightness again when the person leaves or remains stationary for 20-180 seconds (according to the time you set). The factory preset time is 20s and the brightness is 20%.

TIME - Adjust Lighting Time: Adjust the "Time" knob with a flat head screwdriver (Not Included). Turn clockwise to increase the lighting time, and counterclockwise to decrease the lighting time. For every 1/4 clockwise rotation, the lighting time increases by 60 seconds. The maximum is 180 seconds.

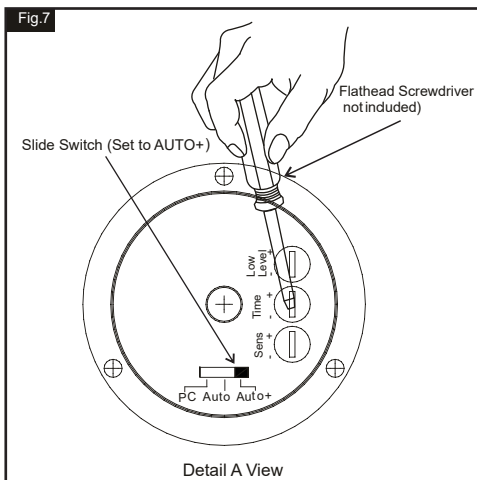

SENS - Adjust Sensing Distance: Adjust the “Sens” knob with a flat head screwdriver(Not Included). Turn clockwise to increase sensing distance, and counterclockwise to decrease the sensing distance. The factory preset distance is 10M(Maximum), you can adjust the “Sens” knob to set it in the range of 3-10 meters.

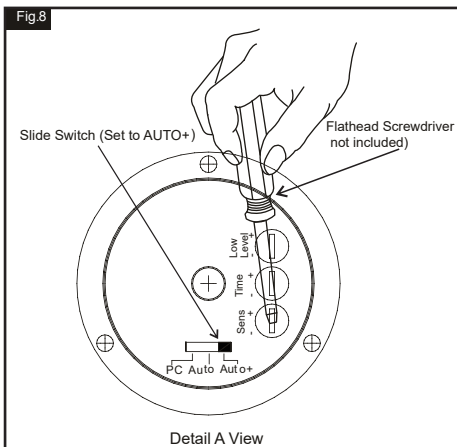

LOW LEVEL - Adjust low-level brightness: Adjust the “Sens” knob with a flat head screwdriver(Not Included). Turn clockwise to increase brightness, and counterclockwise to decrease brightness.

Note:

This function is only available for Incandescent bulbs or dimmable LED bulbs.

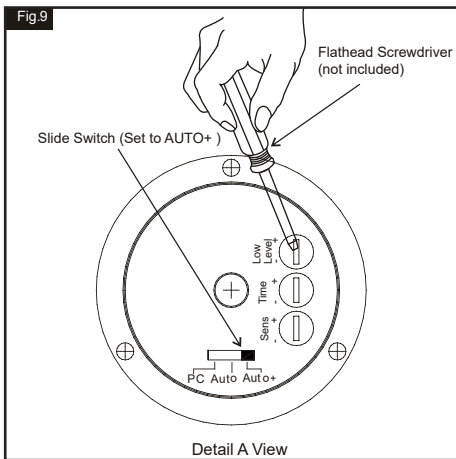

5. PC MODE: Lights off during the day and on at dusk. Other functions are out of work.

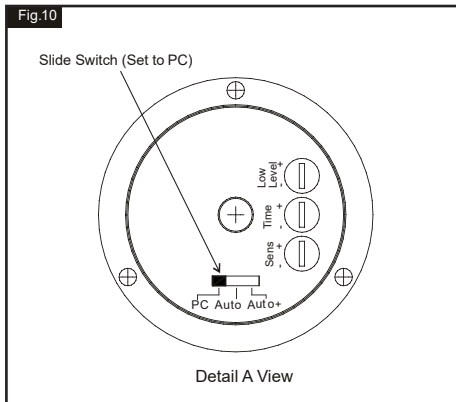

NOTE:

1. The sensitivity of the motion sensor will increase as the environmental temperature drops. For best performance, gently clean the lens with a soft cloth every 1 or 2 months to ensure maximum sensitivity.
2. The magnitude of adjustment for sensitivity and time may not be precisely correspond to the amount of the knob is turned.
3. When installed at a height of 6.5 feet, at 77 degrees Fahrenheit, the light will provide a maximum detection distance of 40 feet and detection range of 180 degrees. (See Fig.11 Fig.12)
4. The sensor will be more sensitive to motion across its detection path than motion directly towards it. (See Fig.13)
5. To reduce possible nuisances, do not mount the fixture near a heat source like an air conditioner, vent or furnace exhaust, or in a direction facing any reflecting object or other light sources.
6. Be sure the light is mounted straight on the wall; otherwise, the detection distance may be limited.

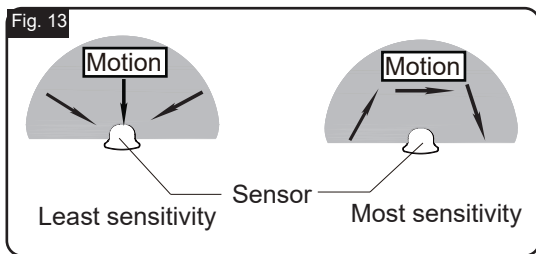
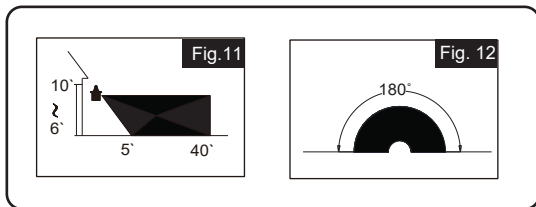

Aftersales service

Warrants this product to be free from defects in material and workmanship for a period of one year from the date of purchase.

Warranty is void if damage is caused by misuse or improper installation. Our dedicated customer service team will get back to you within 24 hours.

Aftersales FAQs

(1)Is there any matching POST LIGHT for sale?

- Yes, we have matching POST LIGHT for sale, you can buy it in our store.

(2)Is the light bulb replaceable?

- Yes. But the light bulb is not included. You can replace it with a suitable bulb (A19 bulb is recommended). Please cut off the power before replacing the bulb.

(3)Can this lamp be used outdoors in rainy and snowy weather?

- Yes. With a rubber pad at the top and a drainage hole at the bottom, the post light can discharge condensed water and other accidental water effectively.

One Year Limited Warranty

Supported by our professional R&D team and QC team, we provide One Year Warranty for materials and workmanship from the purchase date. Please note that the warranty does not cover damage caused by personal misuse or improper installation.

Please attach your Order ID and Name so that our dedicated customer service team can help you better.

