

ASSEMBLY INSTRUCTION

DISPLAY CABINET

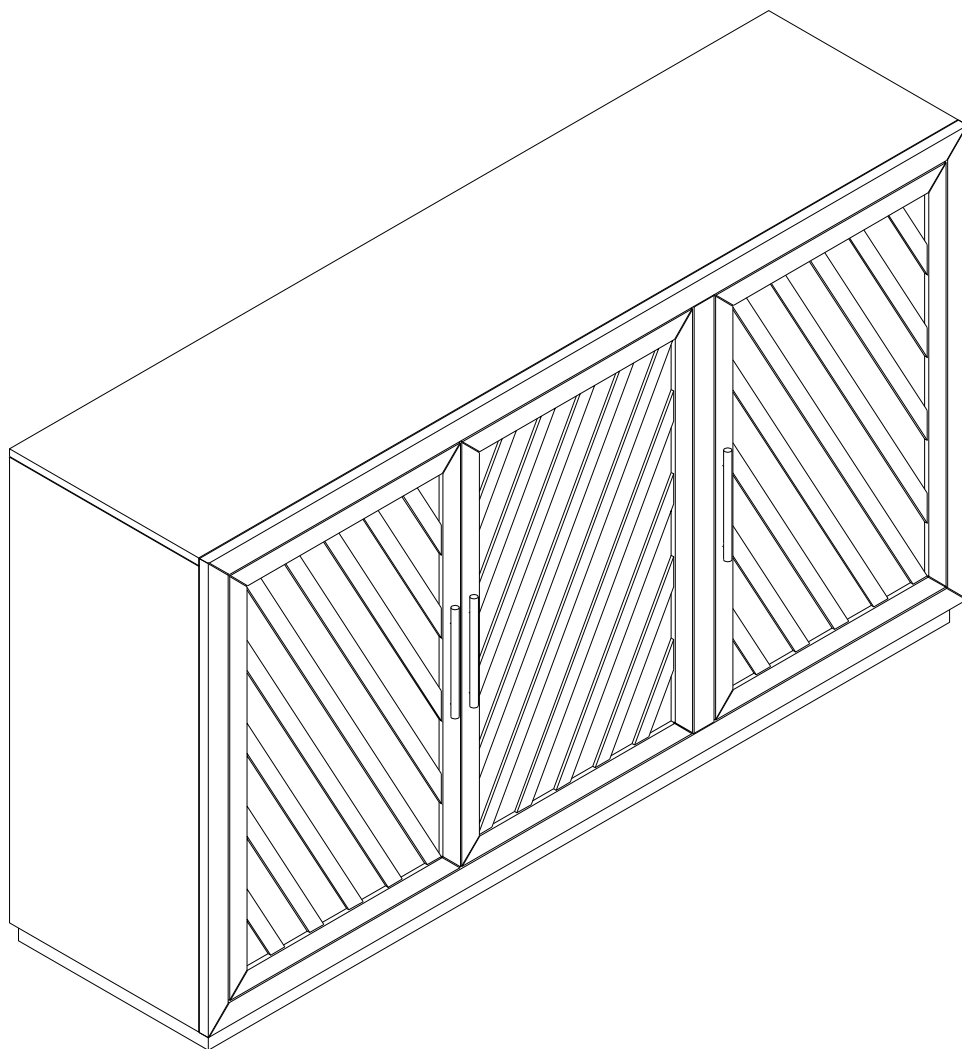

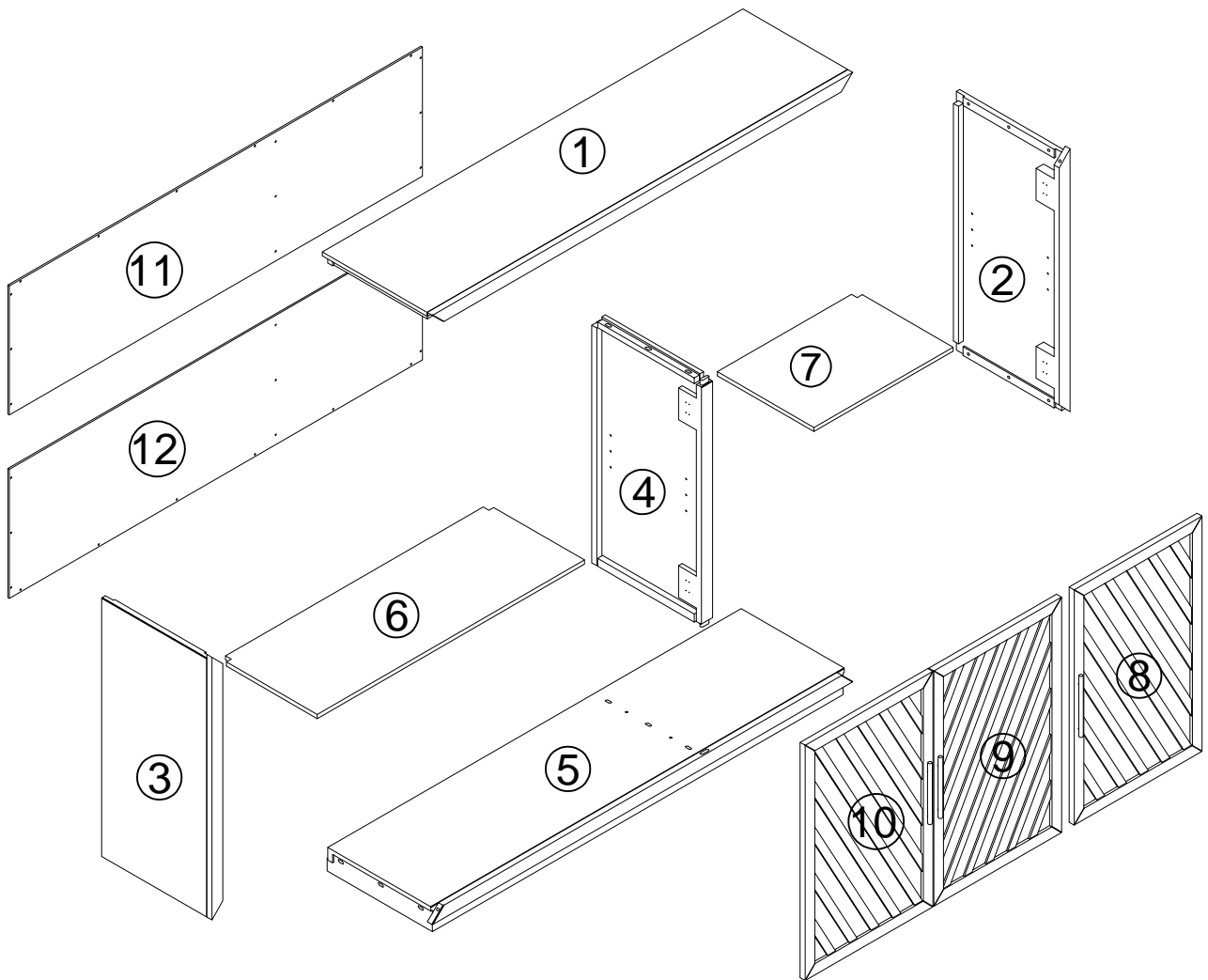

ASSEMBLY INSTRUCTION

Important – Please read these instructions fully before starting assembly

- Check you have all the components and tools listed on the following pages.
- Remove all fittings from the plastic bags and separate them into their groups.
- Keep children and animals away from the work area, small parts could choke if swallowed.
- Make sure you have enough space to layout the parts before starting.
- During assembly do not stand or put weight on the product, this could cause damage.
- Assemble the item as close to its final position (in the same room) as possible.
- Assemble on a soft level surface to avoid damaging the unit or your floor.
- Parts of the assembly will be easier with 2 people.



power drill is set on a low torque setting.

- To reduce the likelihood of damaging your product please ensure that your

Care and maintenance

- Only clean using a damp cloth and mild detergent, do not use bleach or abrasive cleaners.
- From time to time check that there are no loose screws on this unit.
- This product should not be discarded with household waste. Take to your local authority waste disposal centre.

Handy Hints

- Assemble all parts and bolts loosely during assembly, only once the product is complete should you fully tighten the bolts
- Regularly check and ensure That all bolts and fittings are tightend properly.

WARNING In order to help prevent overturning – please follow these instructions

To help prevent product toppling over please follow the below steps:-

Use the anti tip stap or wall fixing method provided (if applicable)
Do not allow children to climb or hang on the furniture
Do not open more than one drawer at a time
Do not place heavy items in the top drawers
Do not place heavy items on top of the furniture, unless the furniture has been designed for this purpose

Please note that only the anti tip strap is provided.

You will need to provide wall plugs and screws applicable for your wall type



Tools required



Phillips screwdriver
(medium & large)

Ruler - Use this ruler to help correctly identify the screws

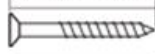

The screws length is measured from the head to the point (30mm screw shown).

Part List & Hardware List

Box 1

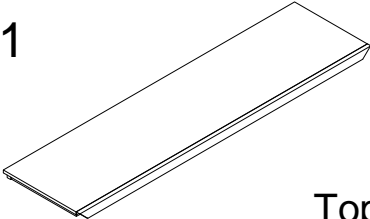
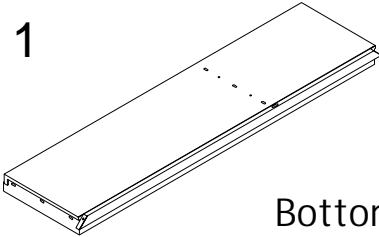
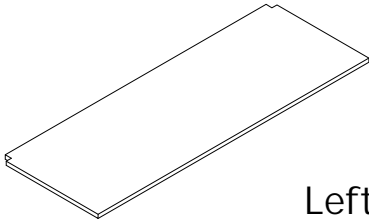
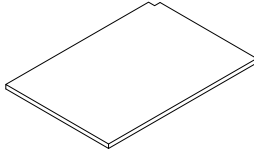
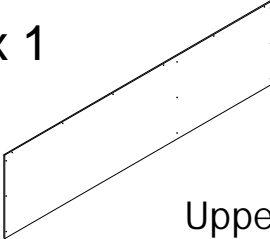
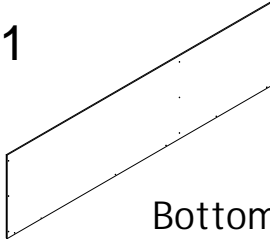
<p>① x 1</p>  <p>Top panel</p>	<p>⑤ x 1</p>  <p>Bottom panel</p>
<p>⑥ x 1</p>  <p>Left shelf</p>	<p>⑦ x 1</p>  <p>Right shelf</p>
<p>⑪ x 1</p>  <p>Upper back panel</p>	<p>⑫ x 1</p>  <p>Bottom back panel</p>





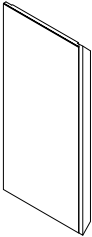
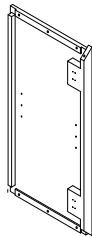
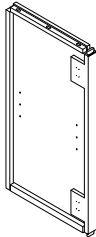
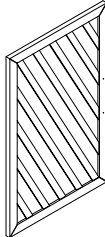
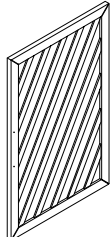
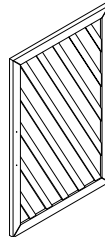

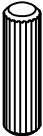
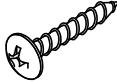
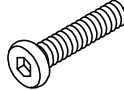
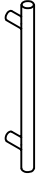
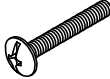
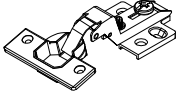

Part List

Box 2

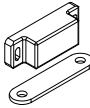
<p>② x 1</p>  <p>Left side</p>	<p>③ x 1</p>  <p>Right side</p>
<p>④ x 1</p>  <p>Partition panel</p>	<p>⑧ x 1</p>  <p>Left door</p>
<p>⑨ x 1</p>  <p>Middle door</p>	<p>⑩ x 1</p>  <p>Right door</p>

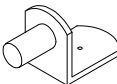
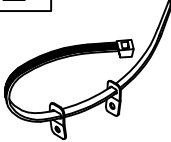
Hardware List

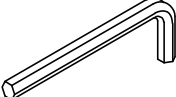

Box 1

<p>A</p>  <p>Ø8 x 30 mm Wood dowel 6pcs</p>	<p>B</p>  <p>M4x20mm Screw round head 30pcs</p>	<p>C</p>  <p>M6 x 30 mm Allen key bolt 18pcs</p>
<p>D</p>  <p>Handle 3pcs</p>	<p>E</p>  <p>M4 x 25 mm Bolt 6pcs</p>	<p>F</p>  <p>Adjustable Hinge 6pcs</p>
<p>G</p>  <p>M4x15mm Wood Screw 36pcs</p>	<p>H</p>  <p>Magnet And Plate 3pcs</p>	<p>I</p>  <p>M3x10mm Wood Screw 14pcs</p>
<p>J</p>  <p>M3x15mm Wood Screw 6pcs</p>	<p>K</p>  <p>Shelf Support 8pcs</p>	<p>L</p>  <p>a.  M4 X 25mm - QTY 2 (1 is extra) b.  M4 X 15mm - QTY 1 c.  M4 X 25mm - QTY 1 FURNITURE TIP OVER RESTRAINT QTY 1 SET</p>
<p>M</p>  <p>Allen key 1pcs</p>		

ASSEMBLY TOOLS REQUIRED (NOT INCLUDED)



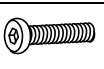

STEP: 1

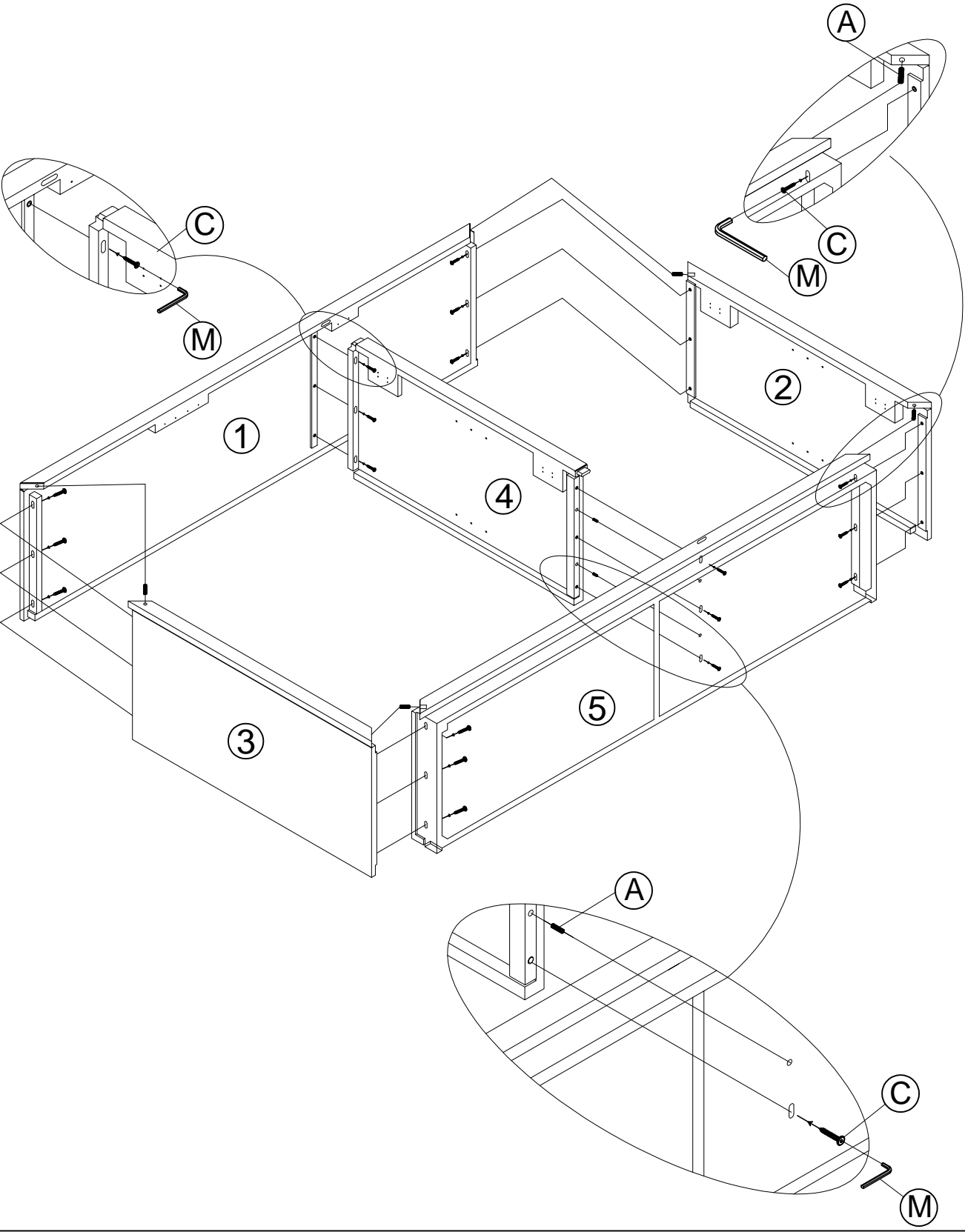
A		6
C		18
M		1



STEP: 2

K		8
I		8

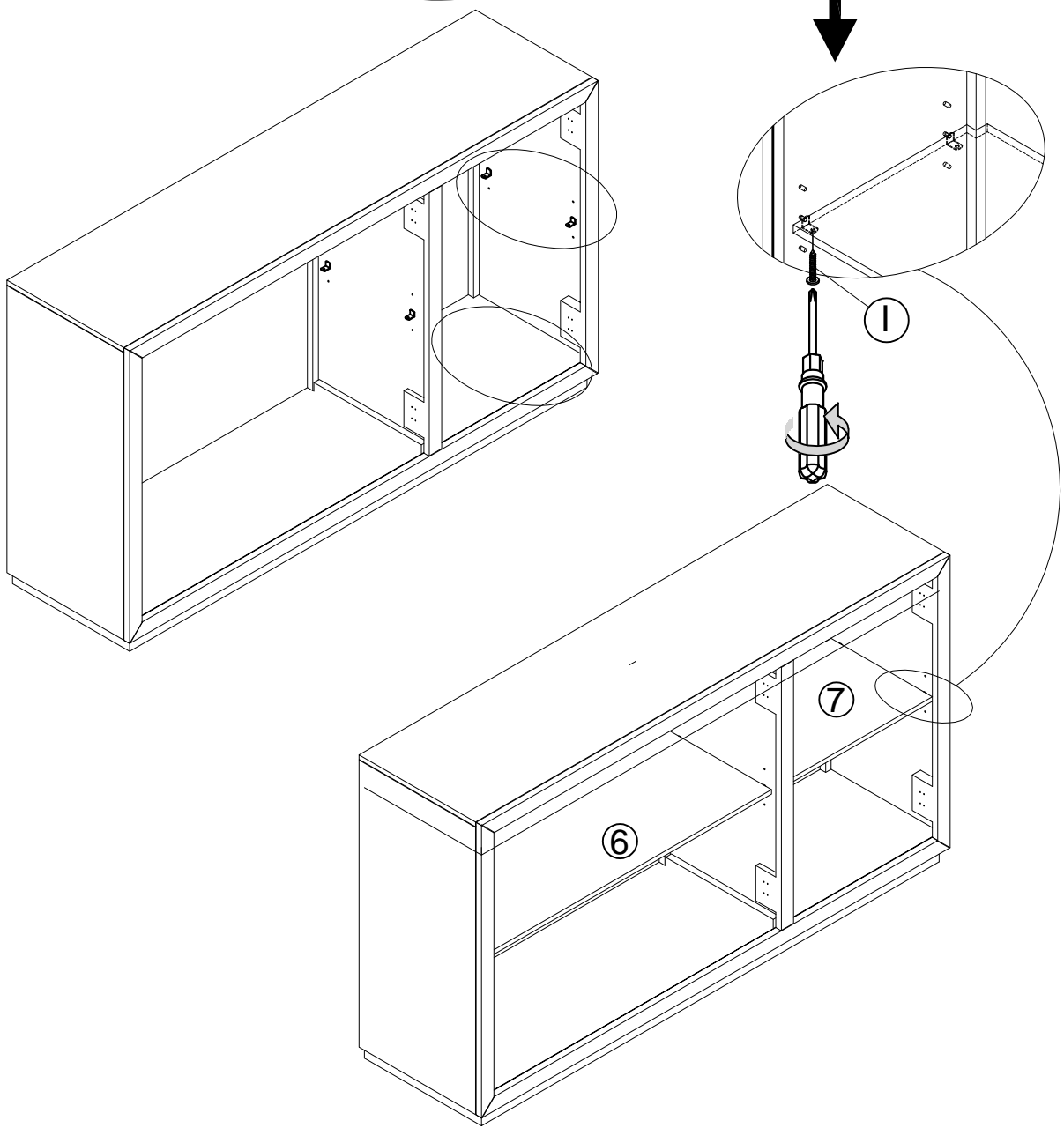
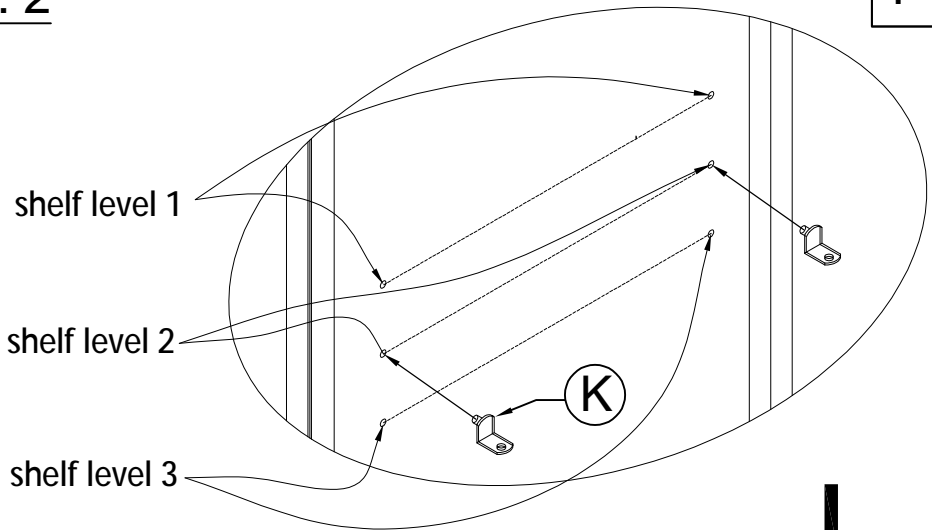

STEP: 3

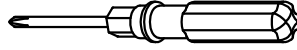



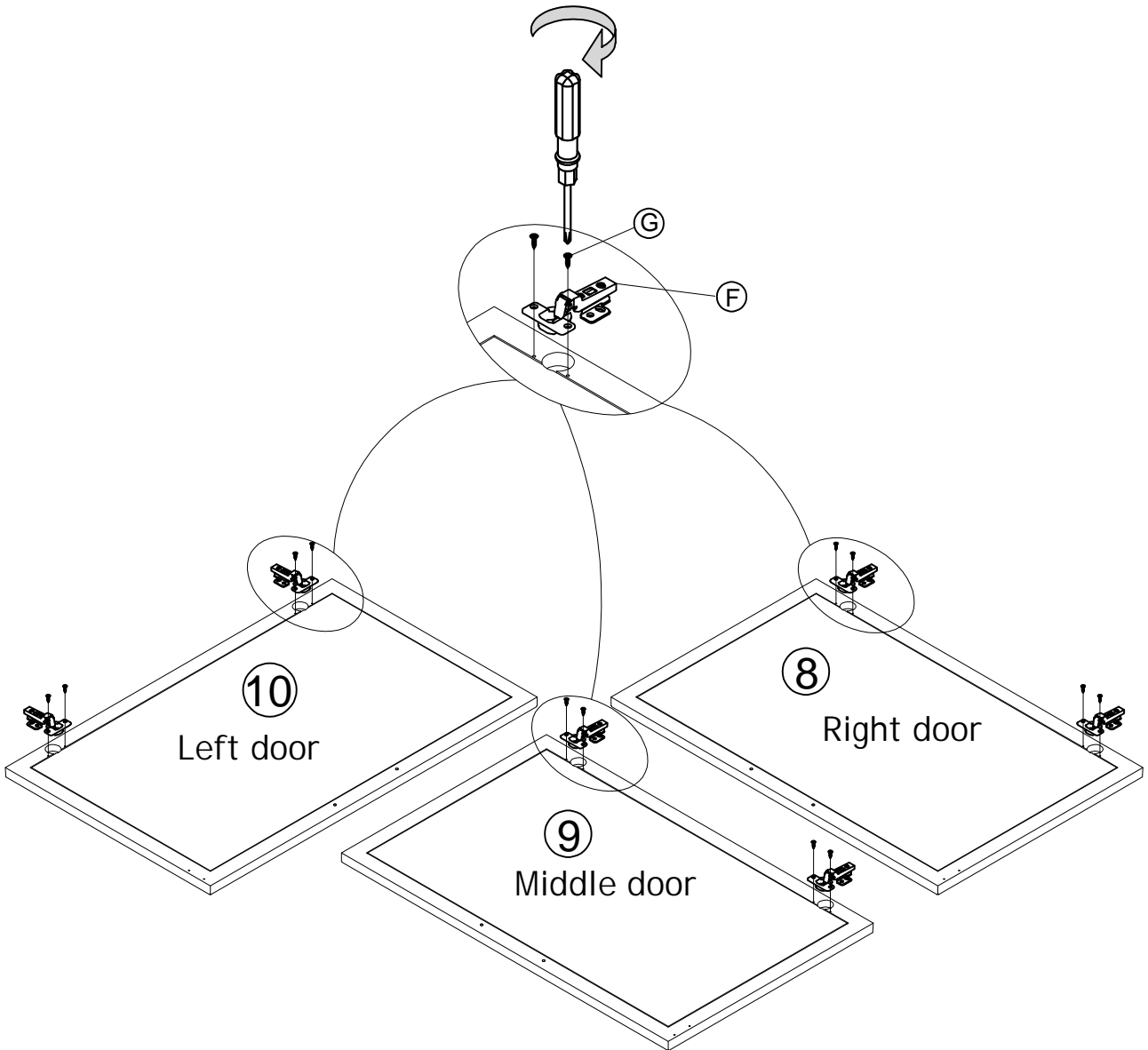

NOTE: The screwdriver is not included in the hardware pack.

G		12
F		6



STEP: 4

NOTE: The screwdriver is not included in the hardware pack.

G		24
I		6
J		6
D		3
H		3

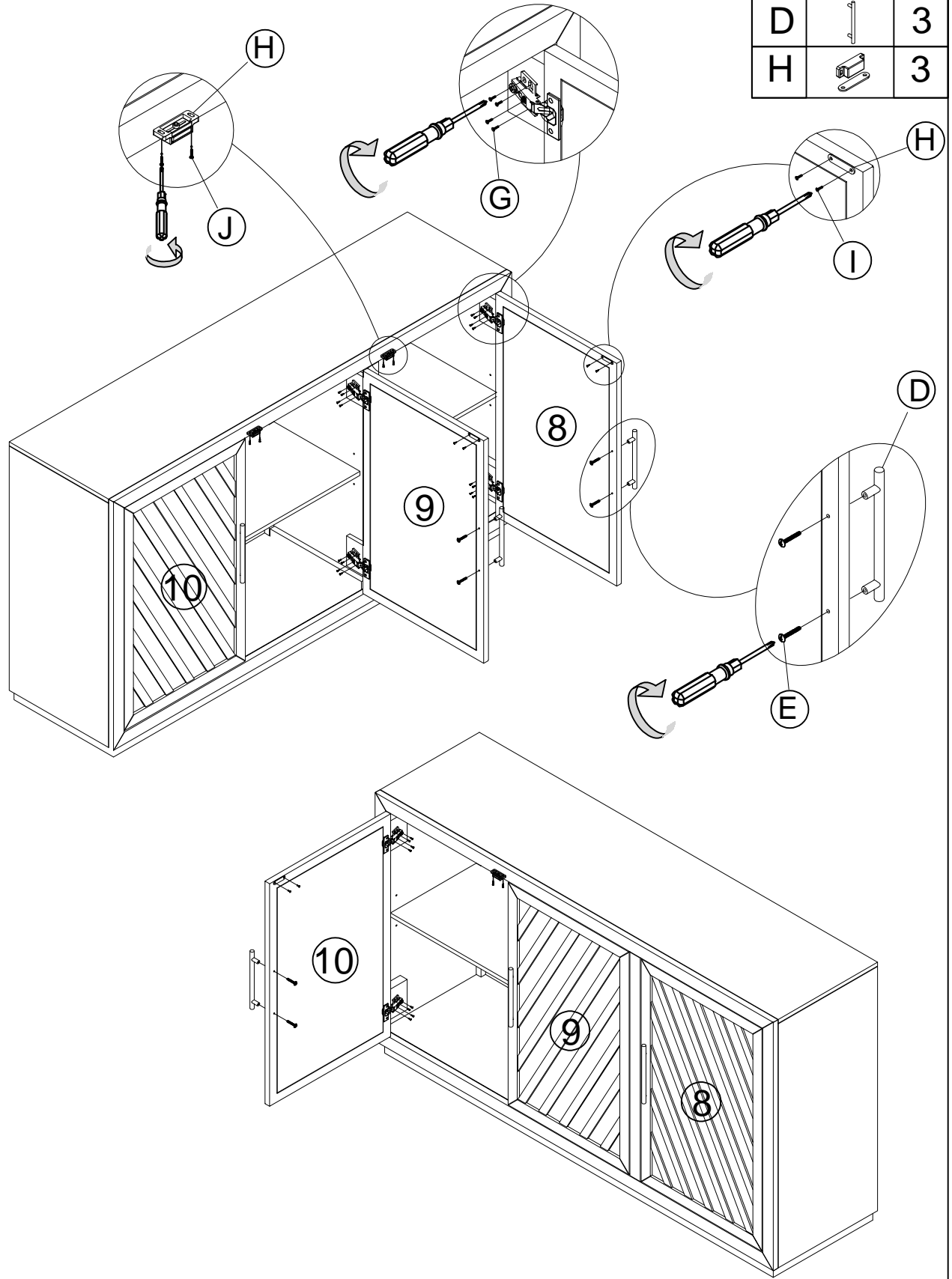

STEP: 5

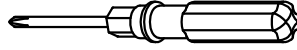

NOTE: The screwdriver is not included in the hardware pack.

B



30

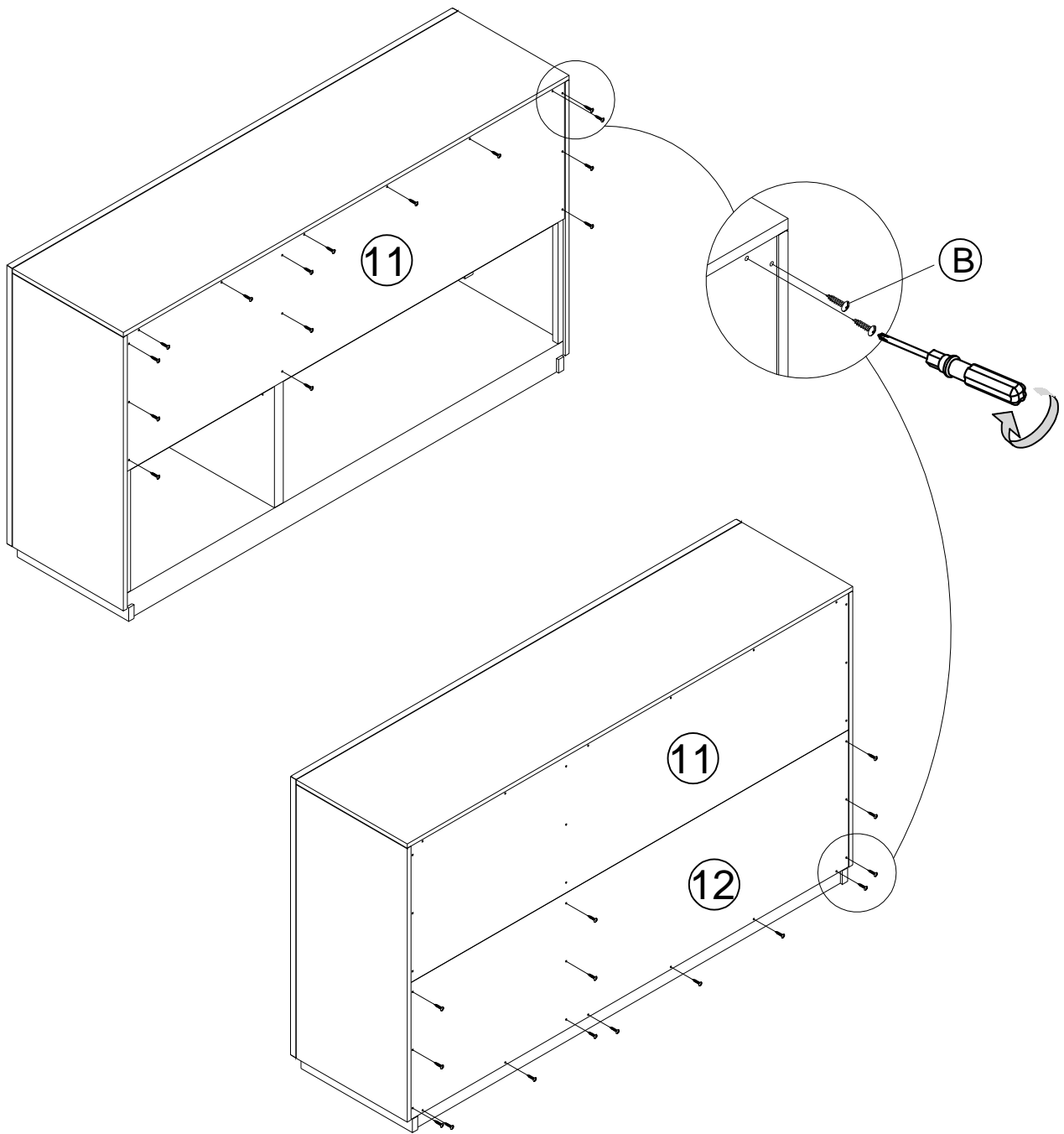



WARNING

Serious or fatal crushing injuries can occur from furniture tip-over.
If the furniture tip over restraint kit is not in the box, please contact our customer service department in order to obtain another kit before using the furniture.

STEP: 6

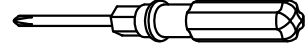

NOTE: The screwdriver is not included in the hardware pack.

