

Assembly Instruction

C is behind D.

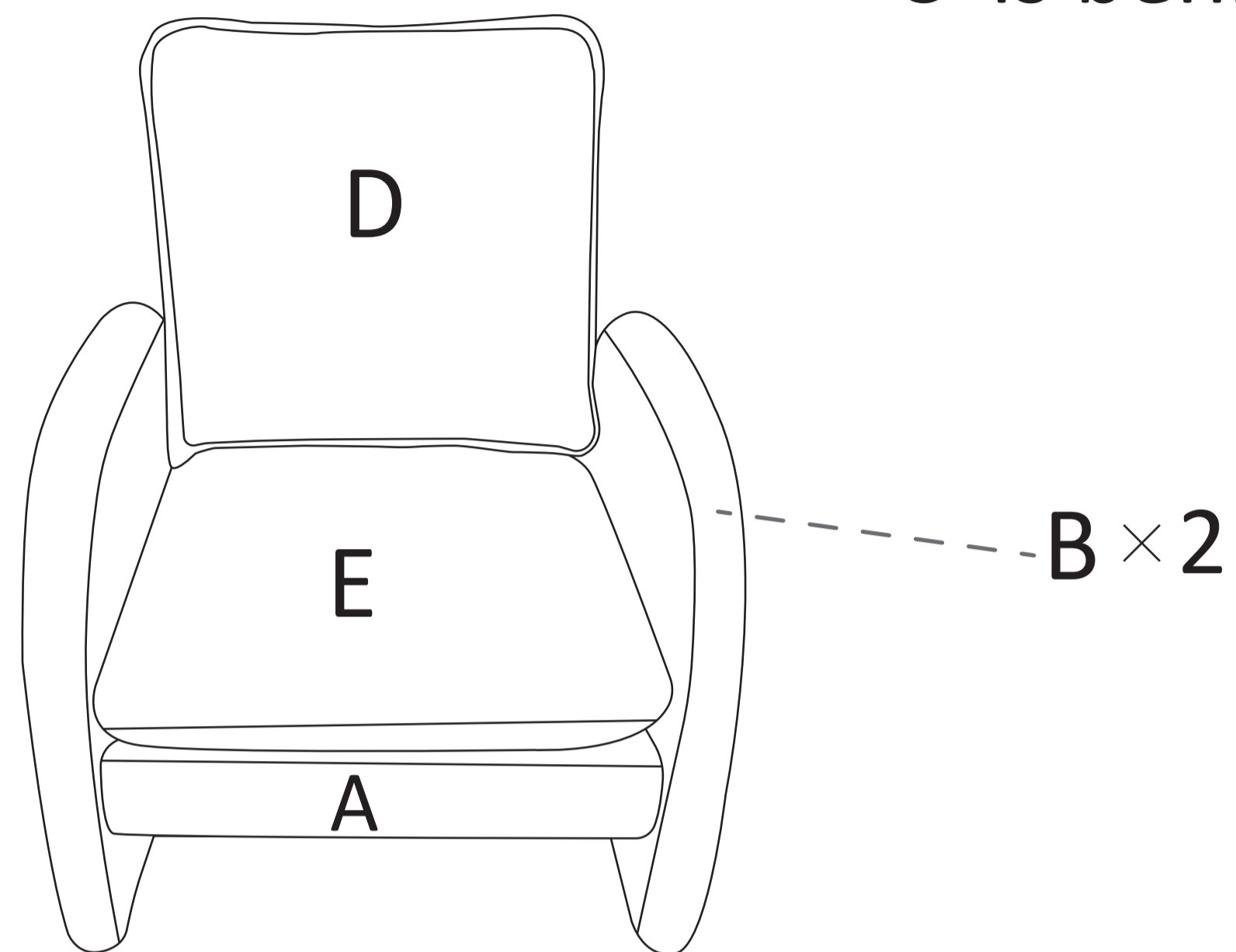

Step 2

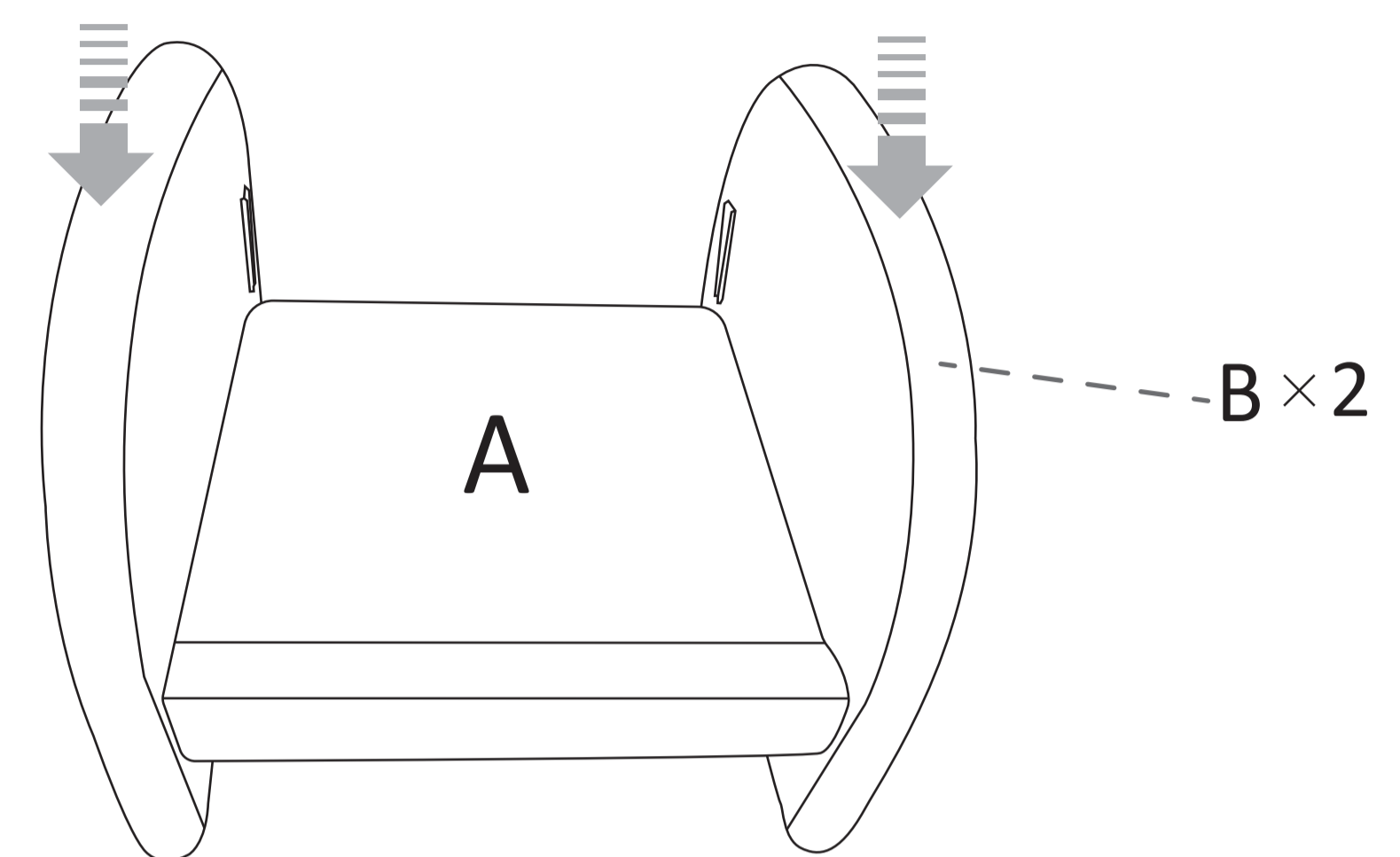

Step 1 Open the package, remove the parts, and check the quantity.

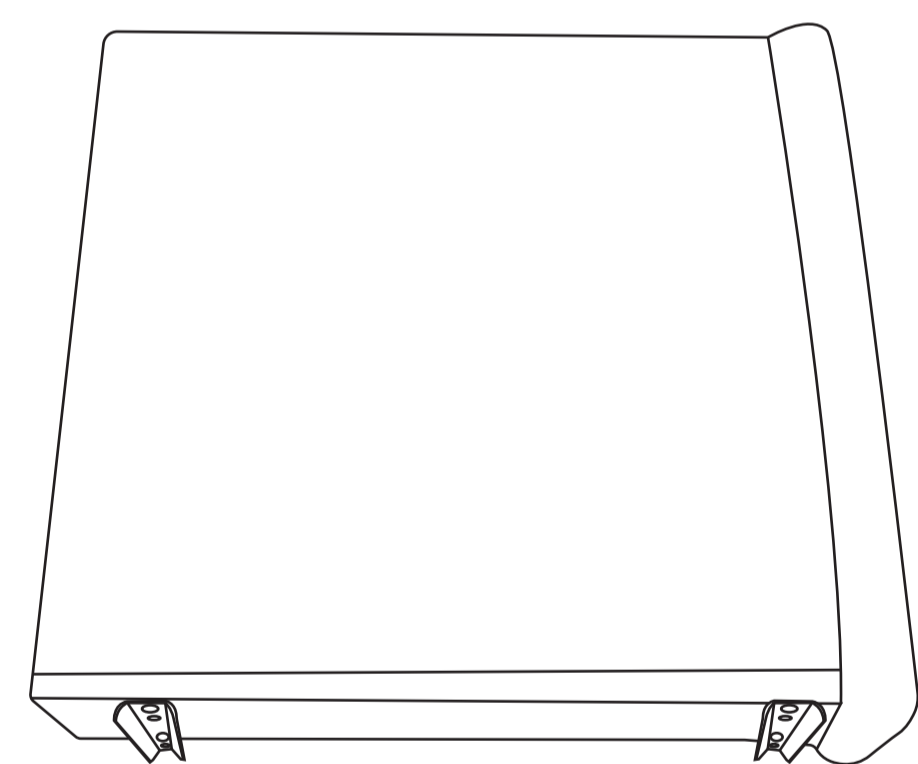

A x 1

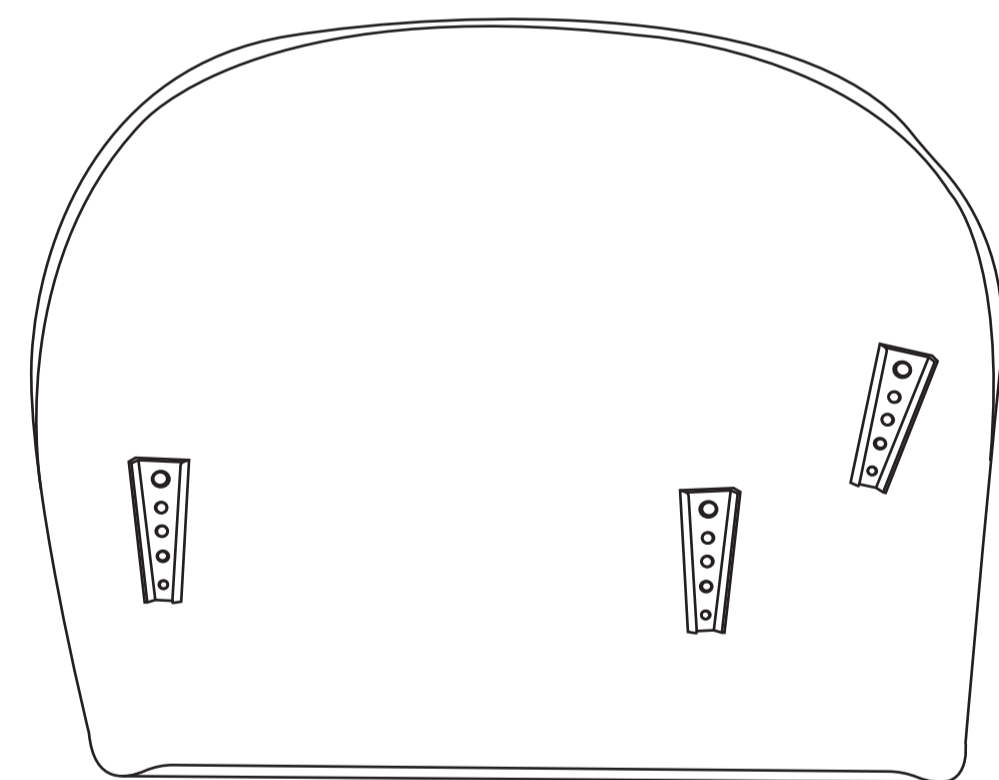

B x 2

Step 3

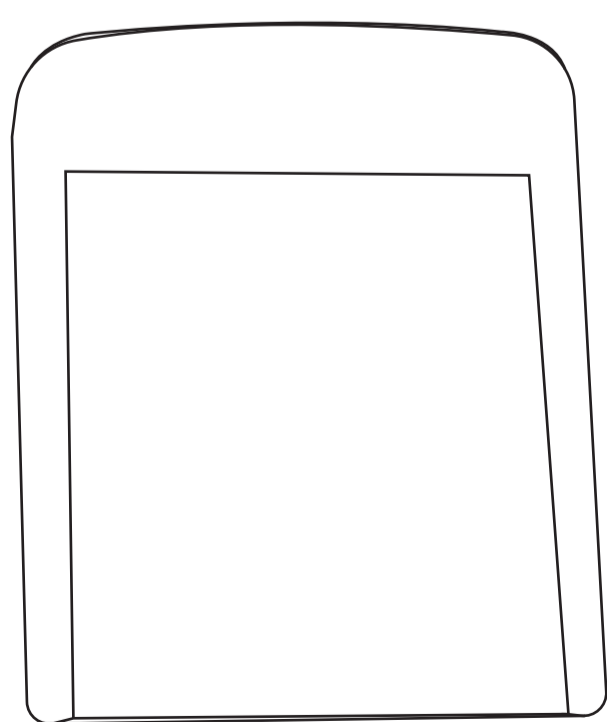
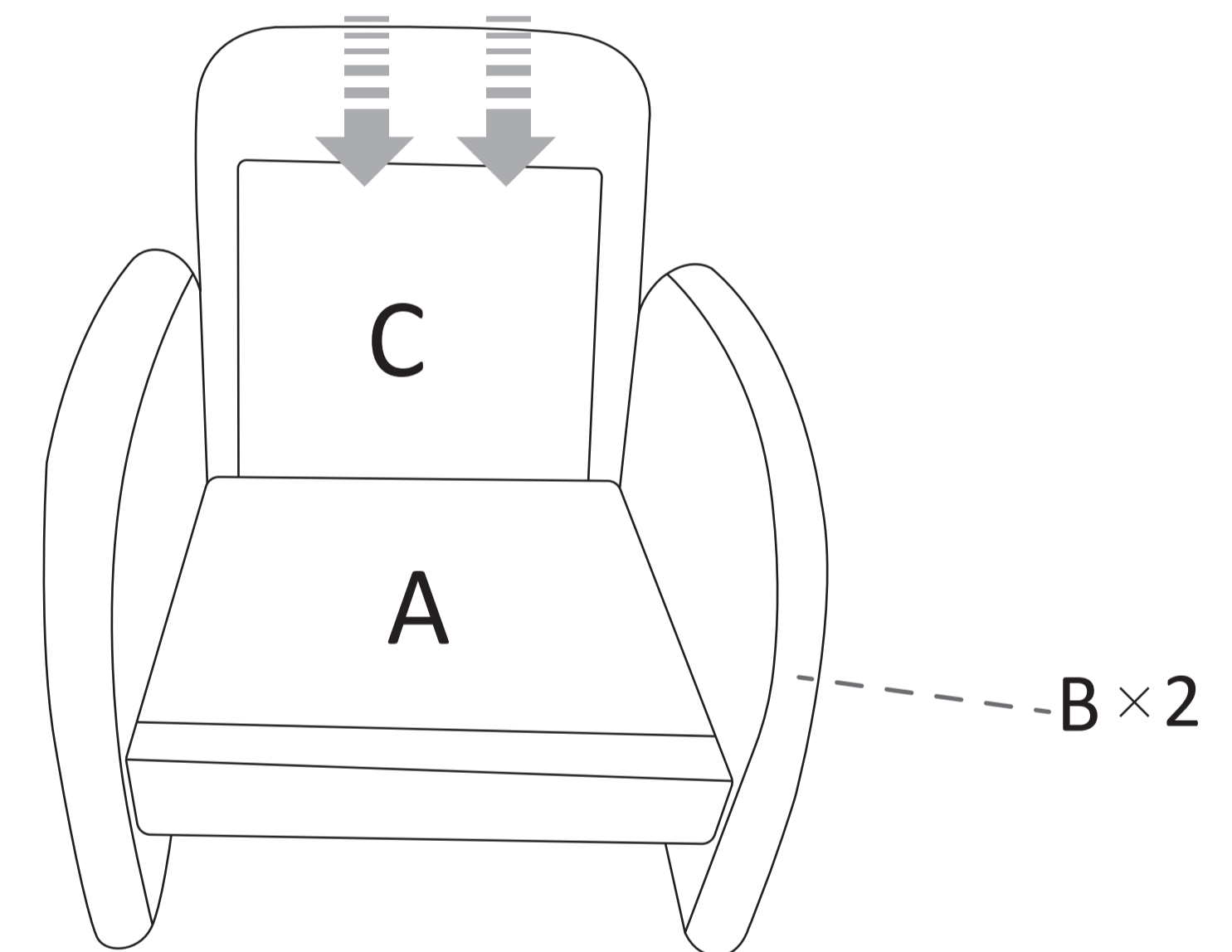

C x 1

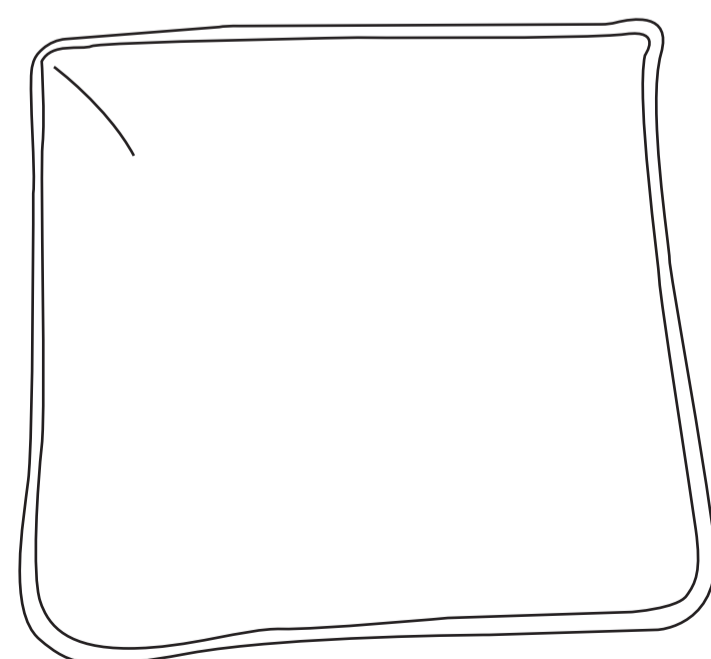

D x 1

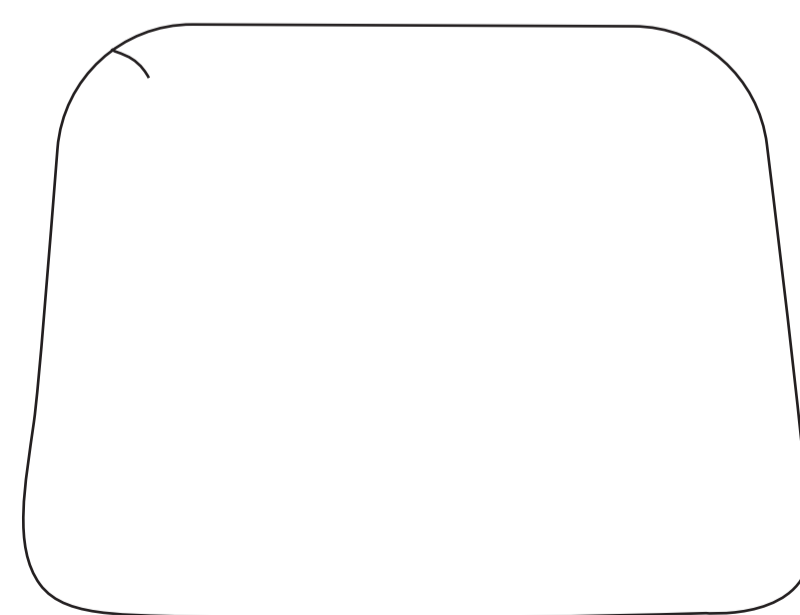

E x 1

Step 3

