









ASSEMBLY INSTRUCTIONS

IMPORTANT

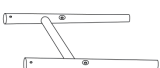
- We suggest you read through this leaflet and follow the simple step-by-step instructions.
- Carefully check that you have all parts before beginning assembly.
- Keep fittings out of children's reach and keep children well away from the assembly area.
- We recommend using the packaging to protect surfaces during assembly.

WARNING

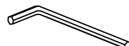
Handle wood components with care during assembly as they can scratch easily.

No.	Illustration	Description	QTÉ/QTY	No.	Illustration	Description	QTÉ/QTY
1		Seat	1	3		Bar	2
2		Legs	2				
A		Long screw	4	D		Spring washer	4
B		Short screw	4	E		Allen key	1
C		Flat washer	4				

1

Attach 2 x bar (3) to 2 x legs (2) using 4 x long screw (A). Tighten loosely with the Allen key (D).

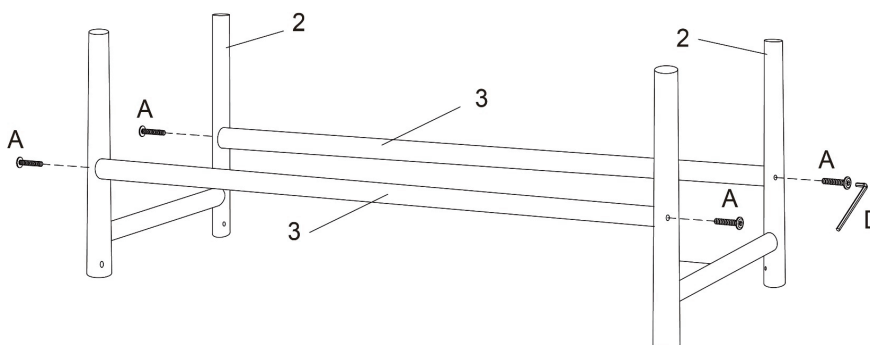

2

Attach the frame assembled in step 1 to the seat (1) using 4 x flat washer (C), 4 x spring washer (D) and 4 x short screw (B). Tighten loosely with the Allen key (E). Then, tighten all screws tightly.

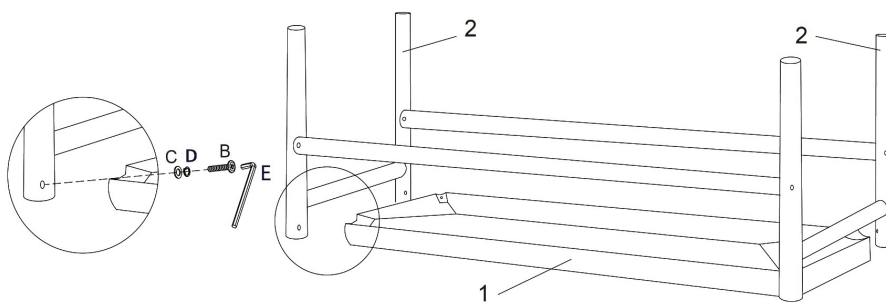

3

